

**PROGRAMMABLE
PROCESS INDICATOR
MODEL 250**



CONTENTS

1. Introduction	1
1.1 Model Number Designation	2
1.2 Intrinsic Safety Approvals	3
2. Specification	4
3. Operation	6
3.1 Display	6
3.1.1 Signal Bar Graph	6
3.1.2 Process Variable	7
3.2 Front Panel Operation	8
3.2.1 Displaying Data	8
3.2.2 Changing Data	10
3.2.3 Timeout Condition	10
3.3 Test Mode	11
3.4 Alarms	12
3.4.1 Types of Alarms	12
3.4.2 Alarm Deadband	13
3.4.3 Alarm Action	14
3.4.4 Setting Alarms	15
3.5 Non-Linearity	16
3.6 Filtering	19
4. Programming	21
4.1 Program Steps	22
5. Signal Input	25
6. Alarm Outputs	26

7. Installation	28
7.1 Wall Mounting	28
7.2 Panel Mount Version	29
7.3 Removing the Front Panel	30
7.4 The Main Electronics	32
7.5 Wiring	33
7.6 Maintenance	33
7.7 Terminal Designations	33
8. Intrinsic Safety Connections	34
9. Instrument Disposal	36
Index	38

1. INTRODUCTION

The Model 250i Process Indicator is a microprocessor based instrument which accepts a 4-20mA input and displays the input signal and the process variable on a large LCD display. It is powered entirely from the 4-20mA loop and, therefore, does not require an external power source.

The input is displayed on a bar graph as 0...100%. The process variable is a 7 digit numeric display which can be spanned in any engineering units.

The instrument is fully programmable; the user can program alarm settings, span & zero and non-linear correction points. Calculation constants are also set from the front panel and are stored in a non-volatile memory which retains data indefinitely.

Suitable relays can be connected directly to the open collector outputs in the Model 250i (see Section 8).

The Model 250i Process Indicator conforms to the EMC-Directive of the Council of European Communities 2014/30/EU, the LVD directive 2014/35/EU and the following standards:

EN61326:2013 Electrical equipment for measurement, control and laboratory use – EMC requirements : Residential, Commercial & Light Industry Environment & Industrial Environment.

EN61010:2010 Safety requirements for electrical equipment for measurement, control, and laboratory use.

In order to comply with these standards, the wiring instructions in Section 7.5

2 Introduction

1.1 MODEL NUMBER DESIGNATION

The Model Number of the 250i describes the input and output options installed and the mounting options.

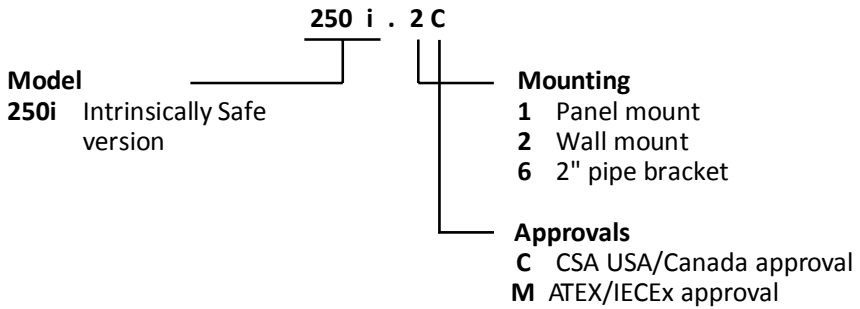

1.2 INTRINSIC SAFETY APPROVALS

The Model 250i is certified for use in hazardous areas and has IECEx, ATEX and CSA *us/c* approvals.

The Model 250i certification details are:

IECEx Approval	IECEx BVS 15.0099X
Rating	EX ia IIB T4 Gb

ATEX Approval	BVS 15 ATEX E 106 X
Rating	II 2G Ex ia IIB T4 Gb

Ambient Temperature: Ambient temperature of -20°C to +60°C.

CSA <i>us/c</i> Approval	LR 104 840-5.
Type:	Class 1, Groups C and D.

When installing in hazardous areas, the instrument will have to be installed according to the guidelines given in Section 9 and in accordance with standards for wiring and installation in hazardous areas.

4-20mA Input

The input can be connected to IS circuits with the following maximum values:

$U_i = 28V$
 $I_i = 93mA$
 $P_i = 653mW$

Relay Outputs

The outputs can be connected to IS circuits with the following maximum values:

$U_i = 28V$
 $I_i = 93mA$
 $P_i = 653mW$

2. SPECIFICATION

General

Display:	Continuously powered LCD.
Level:	30mm bar graph.
Level Span:	0...100% per full scale.
Process:	7 digit with 4½ digit resolution, 12mm (0.5") high.
Process Span:	The units of measure (e.g. pressure) at full scale of input signal. The span is programmable in the range of 0.000...9,999,999.
Decimal Points:	Decimal point positions for the process variable is programmable in range of 0...3 decimal points.
Signal Type:	4-20mA.

4-20mA

Resolution and Linearity:	0.05% of span.
Accuracy:	0.05% of span @ 25°C. 0.1% (typically) of span full temperature range.
Update Time:	0.5 second.
Connection:	2 wire.
Voltage Drop:	2.5V maximum.

Outputs

Type:	4 open collector output alarms suitable for driving dc solenoids or external relays. The outputs
	provide:
	1. High-high.
	2. High.
	3. Low.
	4. Low-low.
Switching Power:	200mA. 30Vdc maximum.
Saturation Voltage:	0.8Vdc across the output in the "on" state.
Isolation:	All outputs are separately opto-isolated.

Physical

Operating Temperature:	-20°C to 60°C.
Dimensions:	97mm (3.8") high x 150mm (5.9") wide x 41mm (1.6") deep (not including cable glands).
Protection:	Nema 4X or IP67 standards.
Cable Entry:	Cable glands.
Mounting:	Universal mounting bracket is supplied as standard.
Pipe Mounting:	A galvanised metal bracket is available which enables the instrument to be mounted on a 2" horizontal or vertical pipe.

3. OPERATION

The Model 250i Process Indicator accepts a 4-20mA input signal from a sensor such as a pressure transmitter, temperature sensor or load cell transmitter. The instrument is powered entirely from the loop and, therefore, requires no external power or internal batteries.

The instrument is fully programmable with all operating parameters and calculation constants programmable from the front panel (see Section 4.1). The setup parameters are stored in a non-volatile memory and are retained indefinitely in the event of a power loss.

3.1 DISPLAY

The display of the Model 250i comprises of:

Process Signal Bar Graph
Process Variable Numeric Display

3.1.1 Signal Bar Graph

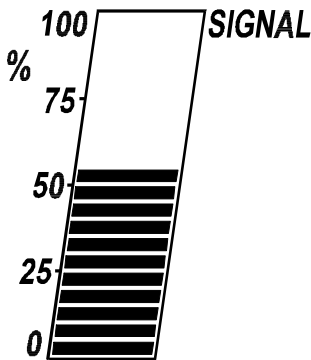

The signal bar graph displays the input signal as a percentage.

Inputs of 4mA and 20mA can be programmed to correspond to 0% and 100% respectively, or can be inverted so that 4mA will correspond to 100% and 20mA will correspond to 0%.

3.1.2 Process Variable

The process variable is a 7 digit numeric display which can be spanned, during setup, to read in any engineering units. The process variable is displayed with $4\frac{1}{2}$ resolution in respect to the maximum reading.

For example, if the maximum reading is 1234567, the display will show up to 5 digits plus trailing zeros. At different inputs the following will be displayed:

1234567 will be displayed as 1234500; 234567 will be displayed as 234500.

However, if the first digit is greater than 1, then up to 4 digits only will be displayed with trailing zeros. For example, if the maximum contents is 2345678, then at different inputs:

2345678 will be displayed as 2345000; 345678 will be displayed as 345000.

CALCULATION OF THE PROCESS VARIABLE

For a **linear signal/process variable** relationship, the contents is calculated as follows:

$$\text{Process Variable} = (\text{Span}) \times (\% \text{ Signal}) + \text{Offset}$$

where the Span and Offset are constants programmed during programming

8 Operation

3.2 FRONT PANEL OPERATION

3.2.1 Displaying Data

The alarm setpoints can be viewed by pressing the DISPLAY key.

Key action means

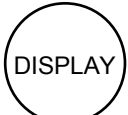

What you will see

If there are flashing alarms on the display they will stop flashing.

What this

Acknowledges alarms if alarms are flashing on the display.

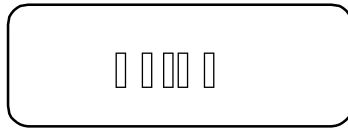
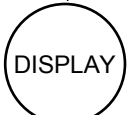

High-high alarm.

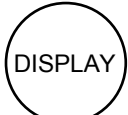
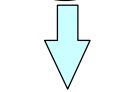

The value of the high-high alarm.

The high-high alarm setpoint as a % of maximum signal or process variable.

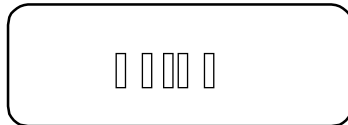
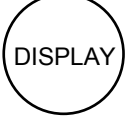
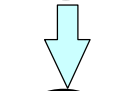

High alarm.



Key action

What you will see

What this

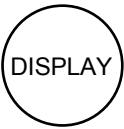

The value of the high alarm.

The high alarm setpoint as a % of maximum signal or process variable.

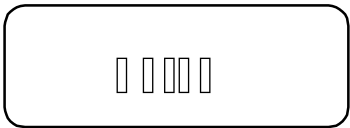
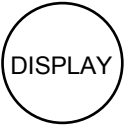

Low alarm.

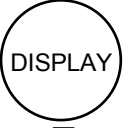

The value of the low alarm.

The low alarm setpoint as a % of maximum signal or process variable.

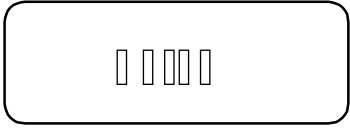
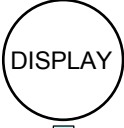

Low-low alarm.

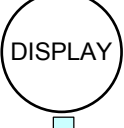

The value of the low-low alarm.

The low alarm setpoint as a % of maximum signal or process variable.

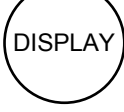

Returns to contents display.

10 Operation

3.2.2 Changing Data

Each of the above parameters can be changed as follows:

1. Pressing the DISPLAY key consecutively until the numeric value of the parameter to be changed appears (as described in the previous diagram).
2. This value can then be changed using the following keys:





This key steps from digit to digit, causing the digit to flash. Only flashing digits can be changed.



This key increments the flashing digit.

Example.

To change the high alarm setpoint to 75:

1. Press DISPLAY until the value of the high alarm appears. This will be the value after AL-HI.
2. The first digit is flashing, this means it can be changed. Using the  key, this digit is changed to 7.
3. The  key is pressed so that the second digit flashes.
4. Using the  key, this digit is changed to 5.

Note that the Model 250i can be programmed so that the above parameters cannot be changed, see Section 4.1.

3.2.3 Timeout Condition

Upon entering the display mode, if no key is pressed for 10 seconds, the display returns to the process variable display with alarm acknowledgment cleared.

3.3 TEST MODE

The 250i has a test mode which can be entered by simultaneously pressing all 3 front panel keys. There are 3 tests:

<i>Low Test</i>	By pressing the ▷ key, the low and low-low alarms outputs will be energised.
<i>High Test</i>	By pressing the △ key, the high and high-high alarm outputs will be energised.
<i>Display Test</i>	By pressing the DISPLAY key, all segments of the display will flash.

To exit the test mode all three keys are pressed simultaneously.

12 Operation

3.4 ALARMS

The Model 250i has 4 alarm outputs:

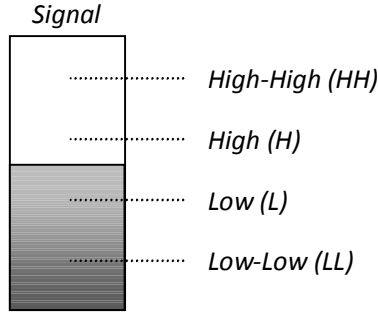

The alarms can be assigned to **signal** or **process variable** which is done during programming (see Section 4.1). Each alarm is individually programmed as a percentage (0-100%) of signal or process variable.

All of the alarms have open collector outputs and are separately isolated via opto-isolators. The outputs are internally protected against voltage spikes caused by relays and coils.

3.4.1 Types of Alarms

3.4.1.1 Alarm Output

The Model 250i can be programmed for the alarm outputs to operate in one of two ways:

1. The alarm outputs can **energise** (switch on) during an alarm condition,
- or; 2. The alarm outputs can **de-energise** (switch off) during an alarm condition.

3.4.1.2 High Alarms

The high alarms will be activated when the signal or process variable increase above the high alarm setpoints. These alarms will be deactivated when the value falls below these programmed setpoints.

When setting the alarms, the high-high alarm should be set higher than the high alarm.

3.4.1.3 Low Alarms

The low alarms will be activated when the signal or process variable falls below the low alarm setpoints. These alarms will be deactivated when the value exceeds the programmed setpoint.

Similarly, when setting the low alarms, the low-low alarm should be set below the low alarm.

3.4.2 Alarm Deadband

To prevent an alarm toggling on and off when the signal is close to the setpoint, a user programmable deadband is provided. The deadband is a percentage (0-100%) of the maximum signal or process variable.

Example 1.

If the low alarm is set to 20% and the deadband is set to 5%, the alarm will be activated when the value reaches 20%. The alarm will then stay activated until the value increases above 25%.

Example 2.

If the high alarm and deadband are set at 80% and 5% respectively, the alarm will be activated at 80% and will stay activated until the value falls below 75%.

14 Operation

3.4.3 Alarm Action

When an alarm condition exists the Model 250i will act in the following way:

1. The appropriate alarm output will be activated.
2. The display will flash the name of the alarm.
3. In some cases these alarms may be acknowledged from the front panel. This will depend on whether they are programmed as **continuous** or **acknowledgeable alarms**. This is set up during programming (see Section 4.1).

The differences between acknowledging continuous and acknowledgeable alarms are described in the table below.

Acknowledgeable Alarms	Continuous Alarms
1. These alarms are acknowledged by pressing the DISPLAY key.	1. A continuous alarm cannot be acknowledged.
2. Once the alarm is acknowledged the flashing on the LCD will cease, with the alarm message remaining solid. The message will remain on the screen until the	2. The flashing on the LCD cannot be stopped and will keep flashing until the alarm condition no longer exists.
3. Once the alarm is acknowledged, the alarm output will be deactivated.	3. The alarms will only be deactivated when the signal (or process variable) is outside alarm conditions.
Note that acknowledging the LL alarm will also acknowledge (and deactivate) the L alarm. Similarly, acknowledging the HH alarm will also acknowledge (and deactivate) the H alarm.	

3.4.4 Setting Alarms

To set any of the alarms:

1. Press the DISPLAY key until the name of the alarm to be changed appears (see Section 3.2.1).
2. Use the \triangleright and \triangleleft keys to change the value of the alarm.
3. Press the DISPLAY key until the original screen appears.

16 Operation

3.5 NON-LINEARITY

The Model 250i can be programmed to correct for the non-linearities between the signal input and the process variable.

A correction table, which corrects for non-linearities, can be programmed during setup. This table works as follows:

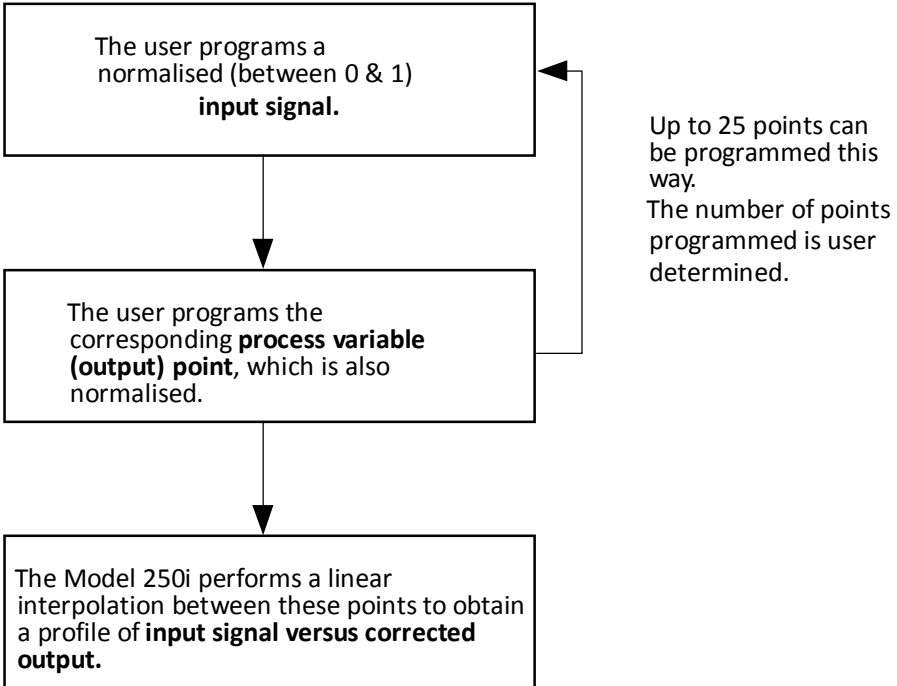

DETERMINING THE NON-LINEAR CORRECTION TABLE

Example.

A spherical tank has a diameter of 10m. The tank has a pressure transmitter mounted at the base of the tank which records the head of liquid in the tank.

The pressure transmitter zero is set at 5kPa and the span is 100kPa. The following 15 point relationship has been determined:

	Input		Process Variable (Volume)	Normalised Inputs for Table	
	Pressure kPa	Pressure Transmitter Output	m ³	Input	Output
1	5.00	4mA	3.796	0.000	0.000
2	10.94		17.421	0.0625	0.026
3	16.88		39.699	0.125	0.069
4	22.81		69.314	0.188	0.126
5	28.75		104.951	0.250	0.195
6	34.69		145.295	0.313	0.272
7	40.63		189.031	0.375	0.356
8	46.56		234.844	0.438	0.444
9	52.50		281.418	0.500	0.534
10	58.44		327.438	0.563	0.623
11	64.38		371.590	0.625	0.708
12	70.31		412.557	0.688	0.786
13	76.25		449.025	0.750	0.857
14	82.19	479.678	0.813	0.916	
15	88.13	503.202	0.875	0.961	
	94.06	518.280	0.937	0.990	
	100.00	20mA	523.599	1.000	1.000

18 Operation

Where,

$$\text{Normalised Input} = \frac{\text{Pressure}}{\text{Pressure at 20mA}}$$

or

$$= \frac{\text{Pressure} - (\text{Pressure at Zero})}{(\text{Pressure at Span}) - (\text{Pressure at Zero})}$$

If the Zero is > 0

So, for example, at 94.06kPa the normalised input is:

$$= \frac{(94.06 - 5)}{100 - 5}$$

$$= 0.937$$

Similarly,

$$\text{Normalised Output} = \frac{\text{Process Variable}}{\text{Process Variable at 20mA}}$$

or

$$= \frac{\text{Process Variable} - (\text{Process Variable at Zero})}{(\text{Process Variable at Span}) - (\text{Process Variable at Zero})}$$

If the Zero is > 0

So, for example, at 94.06kPa the volume is 518.280m³ and the normalised output is:

$$= \frac{(518.280 - 3.796)}{(523.599 - 3.796)}$$

$$= 0.990$$

SELECTING THE NUMBER OF POINTS FOR NON-LINEAR CORRECTION

The user can program up to 25 points. However, the values at 4mA or 20mA which are set at 0 and 1 respectively, are not programmed. It is not always necessary to program all 25 points, as it will depend on the shape of the tank.

3.6 FILTERING

Input fluctuations in the signal can interfere with the stability of the signal and process variable readings. For this reason, the Model 250i has a digital filter which will average out these fluctuations and enable accurate readings.

The degree of filtering of the input signal can be adjusted, depending on the amount of fluctuation and the particular application. Values from 1 to 99 can be programmed, where 1 corresponds to no filtering and 99 corresponds to heavy filtering. Such flexibility in filtering means that highly accurate and stable readings can be obtained.

When programming the degree of filtering, it is advisable to start with no filtering (the factor equals 1) and gradually increase until a steady reading is obtained. It is important that the filtering is not too heavy because this will cause an over-damped response.

The graph on the following page shows the time to reach 90% and 99% of a new reading for a step change in input signal.

**Filter Factor vs Time to Reach New Reading
(for a step change in input signal)**

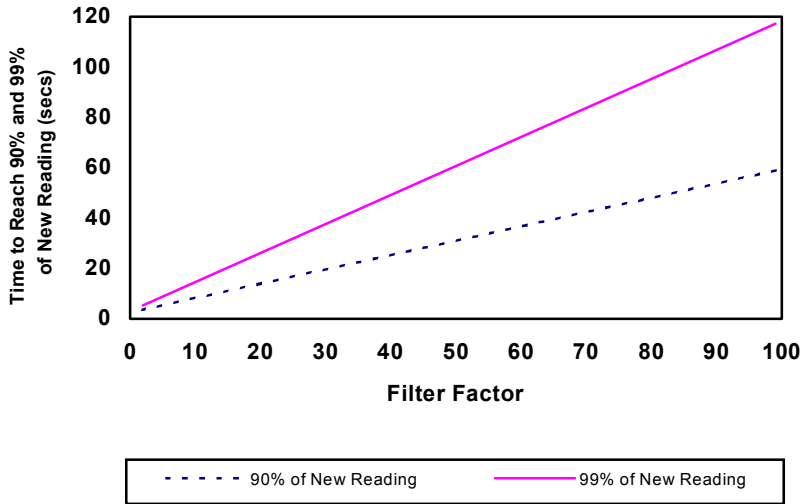

4. PROGRAMMING

The Model 250i is fully programmable with all parameters being stored in memory.

To enter the Program Mode:

Remove the lower cover strip (the dark grey strip along the bottom of the front of the enclosure) and replace it the reverse side up. This brings a small magnet on the inside of the cover strip in contact with a reed switch inside the instrument. The word "Set" is then displayed.

To exit Program Mode:

The grey strip should be replaced the correct way up.

The key switch actions are as follows:



This key steps from digit to digit, causing the digit to flash.



This key will increment a flashing digit or change a parameter selection.

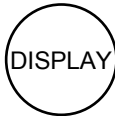

This key will step through the program sequence.

In stepping through the program sequence (using the DISPLAY key), the parameter description is displayed first, followed by the actual value or parameter.

When a value or parameter can be changed it is shown as flashing.

22 Programming

4.1 PROGRAM STEPS

<i>Step</i>	<i>Display</i>	<i>Description</i>
1	SET	Select whether alarms are assigned to the signal or process variable .
	signal	Alarms are assigned to signal.
	Proc	Alarms are assigned to process variable.
2	TYPE	Select whether alarms are normally energised or normally de-energised .
	NE	Normally energised.
	ND	Normally de-energised.
3	ACT	Select type of alarm action, either continuous on alarm condition or cancel s when alarm is acknowledged.
	N-AC	Continuous on alarm condition.
	AC	Acknowledged and cancelled with display key.
4	DBAND	Alarm deadband.
	xx.xx	Program alarm deadband as a % of maximum signal or process variable.
5	FILT	The filter constant for filtering the input signal.
	1	No filtering.
	to	
	99	Very heavy filtering.

<i>Step</i>	<i>Display</i>	<i>Description</i>
6	INPUT	Select input type; either inverted or non-inverted .
	N-INV	Non-inverted (zero at 4mA).
	INV	Inverted (zero at 20mA).
7	DISP	Select enable or disable . This will allow (enable) or not allow (disable) the user to change the alarm setpoints from the DISPLAY key.
	En	Enable the changing of alarm setpoints.
	Dis	Disable changing alarm setpoints.
8	UNIT	
	Unit	Pressure, Contents, Volume, Rate or (blank) is displayed on the LCD above the process variable.
9	P-DEC	The position of the decimal point for the process variable. The user can select 0, 1, 2, or 3 decimal places.
10	P-SPAN	Span of the process variable. The span can be programmed in the range of 0.000 to 9,999,999.
11	P-00	The zero of the process variable. The zero can be programmed in the range of 0.000 to 9,999,999.

24 Programming

<i>Step</i>	<i>Display</i>	<i>Description</i>
12	LIN	Select whether the input signal is linear or non-linear .
	Lin	Linear.
	N-lin	Non-linear.
<i>Steps 13-17 are displayed only if the input signal is non-linear.</i>		
13	No-PTS	The number of points for non-linear correction. The user can program up to 25 points. Note the user does not program the values at 4mA or 20mA, which are set at 0 and 1 respectively.
14	INP-01	Non-linear correction Input Point #01. The input point for the first non-linear correction point is programmed in the range of 0.000 to 0.999. Input points must be programmed in ascending order.
15	OUT-01 non-	The corresponding Output Point #01 for linear correction is programmed in the range of 0.000 to 0.999.
16	INP-XXX	Non-linear correction Input Point #XX. Subsequent input points are programmed in the range of 0.000 to 0.999.
17	OUT-XXX	The corresponding Output Point #XX. The corresponding output points are programmed.
18	SOFT	The software version used in the Model 250i is displayed.

5. SIGNAL INPUT

The signal input is on terminals 3 and 4 and is connected as follows:

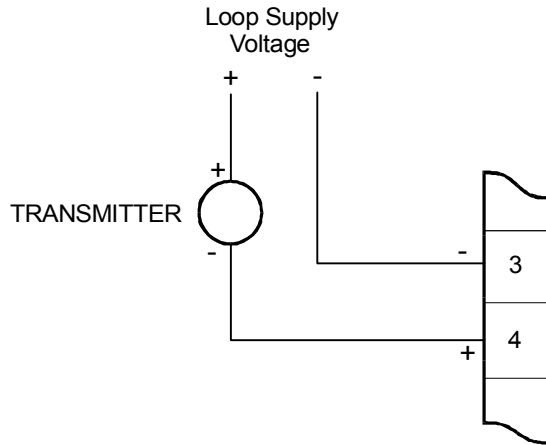

Signal Input

6. ALARM OUTPUTS

Open collector outputs are provided for high and low level alarms. The output can sink up to 200mA and can be used to power external relays, lights or audible alarms. The outputs are internally protected against voltage spikes.

Both outputs are separately isolated via opto-isolators.

Alarm Output Specifications

Maximum Current (sink):	200mA.
Maximum Voltage:	30Vdc.
Saturation Voltage:	0.8Vdc across outputs in energised state.
Isolation:	All outputs are separately isolated via opto-isolators.

Connections

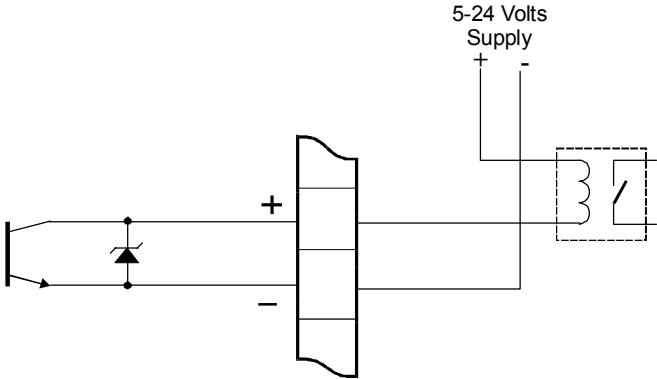

Alarm Relay

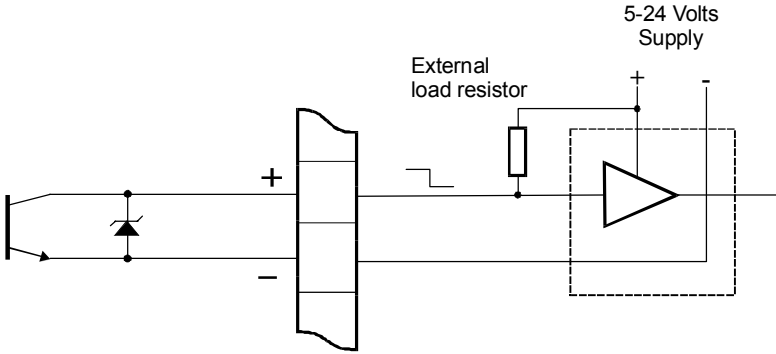

Alarm Output to External Circuit

7. INSTALLATION

7.1 WALL MOUNTING

A wall mounting bracket is supplied with each instrument. Round head screws should be used to attach the bracket to the wall (countersunk screws should not be used). The bracket is mounted first, with the tray section at the bottom. The instrument is then mounted on the bracket with two screws as shown below.

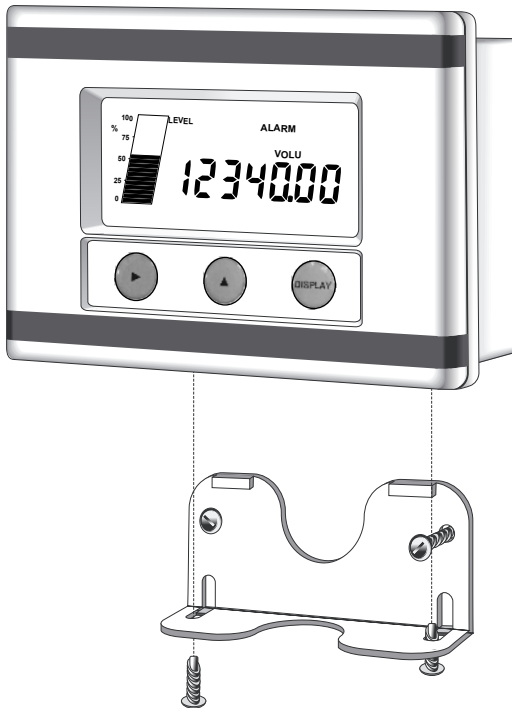

7.2 PANEL MOUNT VERSION

The panel mount version of the Model 250i is supplied with two panel mount brackets and plug-in terminals, which are accessible from the rear of the instrument.

A diagram of the rear panel is shown below:

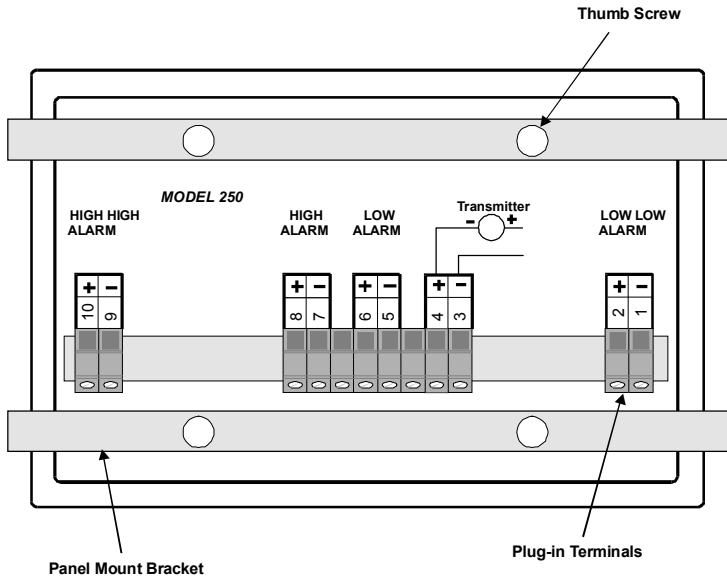

The cutout for this version is 141mm (5.55") wide x 87mm (3.43") high.

30 Installation

7.3 REMOVING THE FRONT PANEL

The front panel should be removed as follows:

1. Remove the top and bottom cover strips (i.e. the dark plastic strip) by levering a screwdriver under one end.
2. Undo the screws retaining the front. Do not remove the screws, they are retained by O-rings.
3. Remove the front panel from the housing.

To replace the front cover, follow the above procedure in reverse. Ensure that the front panel is aligned at connector points before tightening the screws.

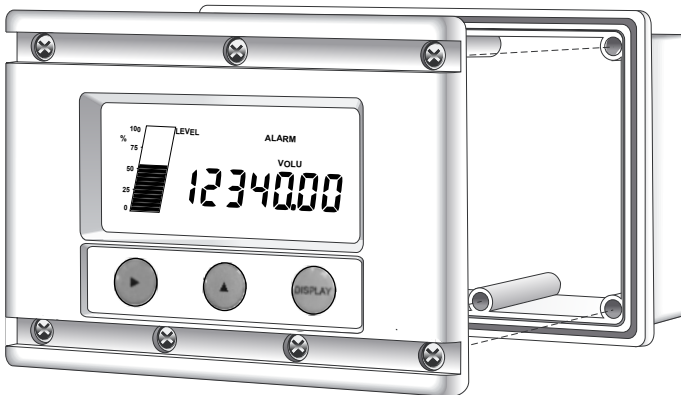
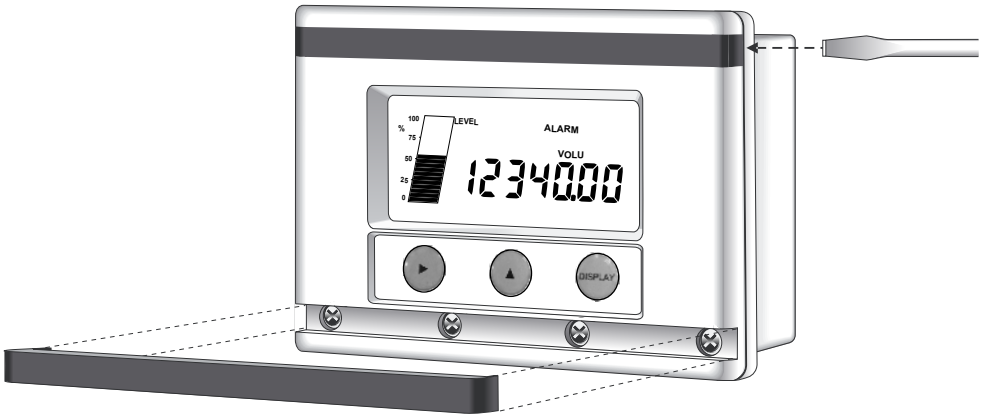

32 Installation

7.4 THE MAIN ELECTRONICS

The front section of the housing contains the microprocessor and display. It is possible to adjust the display contrast via a small potentiometer on the board. The display contrast is shown below and this can be adjusted for optimum contrast.

Adjacent to this control is a reset switch, which can be used to reset the microprocessor. Note that pressing this button will reset all setup parameters.

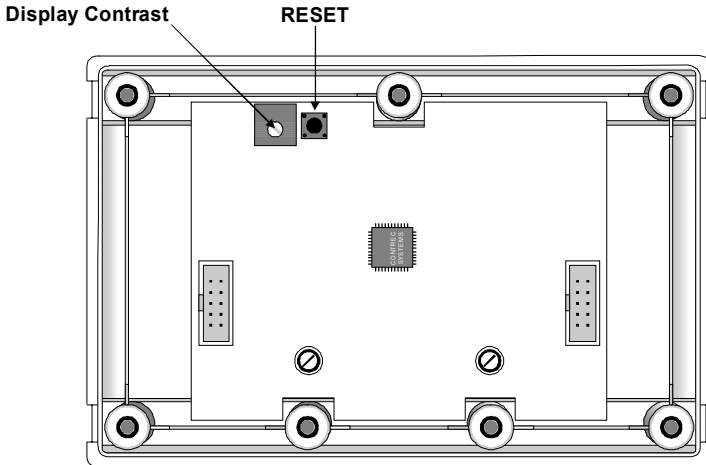

SPECIAL CONDITIONS FOR SAFE USE

To comply with this products ATEX/IECEx certification the special conditions for safe use must be followed.

The Instrument type 250i shall be mounted in an area where electrostatic charge/discharge will be avoided.

7.5 WIRING

When connecting the Model 250i, it is good practice to use shielded cable. The shield should be connected to earth at one end of the cable. The other end of the shield should not be connected.

This wiring practice is mandatory in order to comply with the requirements for Electromagnetic Compatibility as per EMC-Directive 2004/108/EC of the Council of the European Community.

All printed circuit boards must be repaired by Contrec. In the case of a fault, no attempt should be made to repair the board as the intrinsically safe functionality may be impaired.

7.6 TERMINAL DESIGNATIONS

4-20mA Input

3	4-20mA (-)
4	4-20mA (+)

Outputs

1	Low-low Alarm (-)
2	Low-low Alarm (+)
5	Low Alarm (-)
6	Low Alarm (+)
7	High Alarm (-)
8	High Alarm (+)
9	High-high Alarm (-)
10	High-high Alarm (+)

8. INTRINSIC SAFETY CONNECTIONS

When installing the Model 250i in hazardous areas, the wiring and installation must comply with appropriate installation standards.

The approval uses entity parameters and an associated apparatus type approval on the input/output connections to the 4-20mA current loop and alarms. The 4-20mA input and alarm outputs must, therefore, only be connected as shown on the following page to barriers with the specified parameters.

The Model 250i will connect directly to a 4-20mA current loop and alarms, provided they do not exceed the following input parameters:

$$U_i = 28V$$
$$I_i = 93mA$$
$$P_i = 653mW$$

The internal capacitance seen on the input (terminals 3-4) is 0.02uF while the internal capacitance seen on the output (terminals 1-2, 5-6, 7-8 and 10-11) is 0.1uF maximum. Inductance is negligibly small on both the input and output.

Outputs

The four open collector outputs must only be connected to certified IS equipment via barriers as shown on the following page. Only certified intrinsically safe solenoids may be used for IS applications.

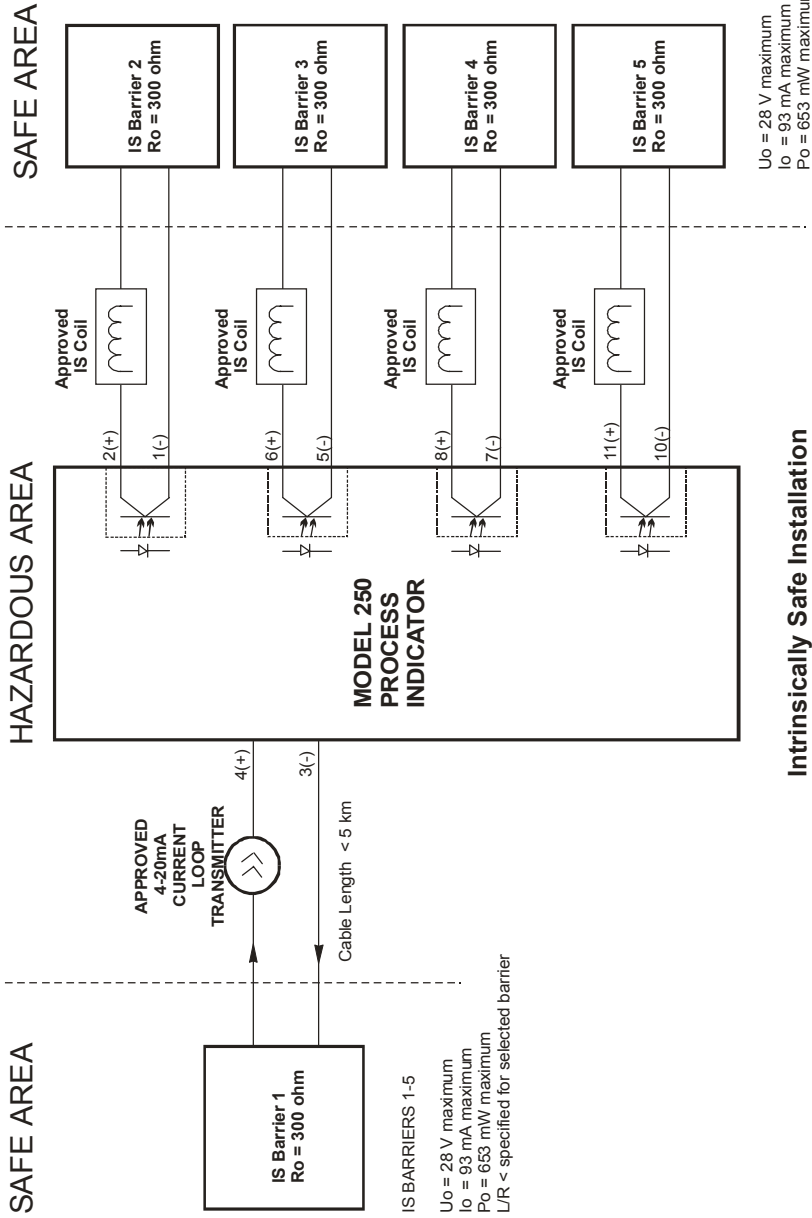

Intrinsically Safe Installation

8. INSTRUMENT DISPOSAL

Contrec instrumentation should not be thrown into the general waste system.



If within EU member states, this instrument should be disposed of according to the guidelines set by the WEEE (Waste Electrical and Electronic Equipment) directive 2012/19/EU. If outside of the EU, this equipment should be responsibly disposed of according to local and national regulations for EEE (Electrical and Electronic Equipment).

By not discarding of this product along with other house hold waste you are preserving natural resources and reducing waste sent to landfill and incinerators.

PAGE INTENTIONALLY LEFT BLANK

Index

4 ½ Resolution, 7

A

Alarms, 12
Acknowledgeable
 Alarms, 14
Alarm Deadband, 13
Alarm Outputs, 26

C

Calculation of Process
 Variable, 7
Continuous, 14

E

Electronics, 32

F

Filtering
 Filter Factor, 20
Front Panel Operation,
8

H

Hazardous, 3
High Alarms, 13

I

Installation, 28
Intrinsic Safety, 3, 34

L

Low Alarms, 13

M

Microprocessor, 32
Model Number, 2

N

Non Linearity, 16

O

Open Collector Outputs,
26

P

Panel Mount, 29
Process Variable, 7

S

Signal Bar Graph, 6
Signal Input, 25
Span
 Offset, 7
Standards, 1

T

Terminal Designations,
33
Test Mode, 11
Timeout, 10

W

Wall Mounting, 28
Wiring, 33