

# Model 515 Flow Computer

## Operation Manual

### Application BR02

Batch/Ratio Process Controller  
for  
Volumetric Analog Flowmeters



17 June 2017

## **Model 515 Flow Computer - Operation Manual**

© Contrec Ltd 2017

The instructions given herein cover the general description, installation, operation and maintenance of the subject equipment. Contrec Ltd reserves the right, without prior notice, to make engineering refinements that may not be reflected in this manual.

Should any questions arise which cannot be answered specifically by this manual, they should be directed to Contrec Ltd for further detailed information and technical assistance.

Contrec Ltd will not accept any liability for either direct or consequential damages resulting from the use or misapplication of the contents of this manual.

Part of the software embedded in this product is eCos - Embedded Configurable Operating System, a trademark of Red Hat. Portions created by Red Hat are Copyright © 1998, 1999, 2000 Red Hat, Inc. (<http://www.redhat.com>). All rights reserved

The software in this product was in part provided by Red Hat and any express or implied warranties, including, but not limited to, the implied warranties of merchantability and fitness for a particular purpose are disclaimed. In no event shall the author be liable for any direct, indirect, incidental, special, exemplary, or consequential damages (including, but not limited to, procurement of substitute goods or services; loss of use, data, or profits; or business interruption) however caused and on any theory of liability, whether in contract, strict liability, or tort (including negligence or otherwise) arising in any way out of the use of this software, even if advised of the possibility of such damage.

### **Contrec Ltd**

Riverside, Canal Road, Sowerby Bridge,  
West Yorkshire HX6 2AY UNITED KINGDOM  
Tel: +44 1422 829944 Fax: +44 1422 829945  
Email: [sales@contrec.co.uk](mailto:sales@contrec.co.uk)

**Website: [www.contrec.co.uk](http://www.contrec.co.uk)**

### **Contrec Systems Pty Ltd**

5 Norfolk Avenue Ringwood, Melbourne 3134 AUSTRALIA  
Tel: +61 4 413 505 114  
Email: [info@contrec.com.au](mailto:info@contrec.com.au)

### **Contrec - USA, LLC**

916 Belcher Drive Pelham AL 35124 USA  
Tel: +1 (205) 685 3000 Fax: +1 (205) 685 3001  
Email: [contrec@contrec-usa.com](mailto:contrec@contrec-usa.com)



**Publication No: 515-BR02-OM - 17 June 2017**



# Safety Notice

**The information in this safety notice is for the prevention of injury to personnel and damage to the instrument.**

**The manufacturer assumes no liability for injury or damage caused by misuse of the instrument or for modifications made to the instrument.**

## **Qualified Personnel**

The instrument must be installed, operated and serviced by persons who have been properly trained and authorised. Personnel must read and understand this manual prior to installation and operation of the instrument.

## **Static Hazard**

The 500 series flow computer uses high speed CMOS circuitry which is sensitive to static damage. The user should observe accepted safety practices for handling electronic devices, especially during servicing. Once the unit is installed, grounded and interconnected, the chances of static damage are greatly reduced.

## **Voltage Hazard**

Before connecting power to the instrument, ensure that the supply voltage for the AC or DC input is suitable. The AC voltage rating is as stated on the instrument rating plate. Personnel should take all due care to avoid electric shock. For safe operation it is essential to connect a mains safety earth to the A.C. power inlet. Do not operate at altitudes above 2000m.

## **Welding Hazard**

Do not perform electric welding in close proximity to the instrument or its interconnecting cables. If welding in these areas must be performed, disconnect all cables from the instrument. Failure to do so may result in damage to the unit.

## **Moisture Hazard**

To avoid electrical faults and corrosion of the instrument, do not allow moisture to remain in contact with the instrument.

## **Disconnection Device**

When powered from a mains supply this unit requires the provision of a suitable mains isolation device to be accessible near to the installed instrument.



# Contents

---

## 1 Introduction

Features	1
Overview	1
Calculations	2
Displayed Information	2
Main Menu Variables	3
Communications	3
Isolated Outputs	3
Relay Outputs	3
Software Configuration	4
Approvals	4

## 2 Specifications

Specification Table	7
---------------------	---

## 3 Installation

Panel Mounting	9
Electrical Connection	10
Rear Panel Connections	10
Terminal Designations	10
Inputs	11
Analog Input Connections	11
Logic Input Connection	12
Outputs	12
4-20mA Output Connection	13
Digital Output Connection	13
Control Relays (Alarms)	14
RC Network for Interference Suppression	15
Communications	15
RS-232 Port	15
RS-485 Port (Optional)	16
Earthing and Shielding	16

## 4 Operation

Front Panel Operation	17
Default Variable	18
Status LEDs	18
Front Panel Keys	18
Main Menu Items	19
Setting the Batch Preset	20
Setting the Flow Control Setpoints	20
Data Logs	20

---

Model Information . . . . .	22
Flow Control Modes . . . . .	22
Tuning the Control Loop . . . . .	25
Batch Operation Modes . . . . .	26
Preset Mode . . . . .	26
On-Off Mode . . . . .	27
Release Mode . . . . .	27
Batch Operation . . . . .	28
Operation Configurations . . . . .	28
Safety and Security . . . . .	29
Starting a Batch . . . . .	29
Stopping a Batch . . . . .	29
Resetting a Batch . . . . .	30
Logic Input Control . . . . .	30
Batch Flow Errors . . . . .	30
Batch Control Processes . . . . .	31

## 5 Instrument Calibration

Introduction . . . . .	35
Calibration View Mode . . . . .	35
Calibration Set Mode . . . . .	36
Changing the Instrument Settings . . . . .	37
Calibration Menu Tree . . . . .	38
Instrument Settings . . . . .	40
Units of Measurement . . . . .	40
Parameters . . . . .	41
Inputs . . . . .	45
Outputs . . . . .	48
Alarms . . . . .	51
Communications . . . . .	52
Time Settings and Data Logging . . . . .	54
General Setup Parameters . . . . .	56
Test Menu . . . . .	58
System Messages . . . . .	59
Error Messages . . . . .	59
Warning Messages . . . . .	60
Prompt Messages . . . . .	60

## 6 Communications

Overview . . . . .	61
Hardware Interconnection . . . . .	61
Protocols . . . . .	63
Simple ASCII Protocol . . . . .	63
Requests Format . . . . .	64
Instrument Responses . . . . .	65
Corrupted or Invalid Requests . . . . .	68
Modbus RTU Protocol . . . . .	69
List of Data Registers . . . . .	70

---

Printer Protocol . . . . .	76
Types of Printouts . . . . .	76
Printer Data Control . . . . .	79
<b>Appendix A Glossary</b>	
Glossary . . . . .	81
<b>Appendix B Model Numbers</b>	
Product Codes . . . . .	83
Custom Version Codes . . . . .	84
Application Information Code . . . . .	84
<b>Appendix C Units of Measurement</b>	
Available Units of Measurement . . . . .	86
<b>Index</b> . . . . .	87





# List of Figures

---

1	Typical Application Diagram . . . . .	4
2	500 Series Instrument Panel Mounting . . . . .	9
3	Rear Panel Connections . . . . .	10
4	Externally Powered Voltage Transmitter . . . . .	11
5	Internally Powered Voltage Transmitter . . . . .	11
6	Externally Powered Current Loop . . . . .	12
7	Internally Powered Current Loops . . . . .	12
8	Logic Inputs Connection Diagram . . . . .	12
9	Output 4-20mA Connection Diagram . . . . .	13
10	Output Pulse Connection Diagram . . . . .	13
11	Relay Connection Diagram . . . . .	14
12	RS-485 Interface Connections . . . . .	16
13	Batch Operation with Manual or Automatic Reset . . . . .	32
14	Batch Operation with Automatic Restart . . . . .	33
15	Calibration Menu Tree Sheet 1 . . . . .	38
16	Calibration Menu Tree Sheet 2 . . . . .	39
17	RS-232 Cable Connections to a Computer . . . . .	62
18	RS-485 Connections . . . . .	62



# Chapter 1

## Introduction

---

### Features

- Tailored for volumetric analog input such as vortex flowmeters
- Single or Dual stage control
- Preset or manual On-Off modes
- Easy access to batch and flow rate presets
- No-flow, leakage and overflow error detection
- Remote RUN/STOP/RESET
- Allows for permissive with prompt
- Uses PI Loop Control
- “Flushing” available via external logic signal
- Allows for non-linear correction
- Storage of 1000 transactions with time and date stamp
- Selection of second language and user tags
- Pulse width and scaling of pulse output
- 4-20mA retransmission
- Selectable protocols on serial ports including Modbus RTU and Printer output
- Front panel adjustment of 8-24V DC output voltage
- Backlit display with LCD backup

### Overview

The 515 BR02 application is a batching flow controller for delivery of preset quantities at preset flowrates using a volumetric analog input. Batch control can operate in preset or on-off modes, while flow control can be set to local (manual) or PI loop mode.

This application provides the operator with clear local readout including flowrate deviation and can be controlled via communications in more automated systems. There is quick access to commonly used preset values directly from the front panel if access has been authorized.

The PI control of the process flow is via a 4-20mA proportional valve or pump controller. It has integral wind-up protection, a deadband, output hold and ramp time that can be programmed to reduce wear on valves and actuators and provide for bumpless operation.

## Calculations

There are three types of control modes in which the process flow is dependent on the main flow. These are RATIO, BLEND-1 and BLEND-2 modes where the relationship between the flows are as follows:

Ratio Control Mode.

The process flow is a ratio of the main flow (0 to 400% range).

$$Ratio\% = \frac{P_{flow}}{M_{flow}} \times 100$$

Blend Control Modes.

These modes cater for blending points before and after the main flowmeter. The process flow is a ratio of the net (combined) flow (0 to 80% range).

$$Ratio\% = \frac{P_{flow}}{Net_{flow}} \times 100$$

## Displayed Information

The front panel display shows the current values of the input variables and the results of the calculations.

The instrument can be supplied with a real-time clock for storage of up to 1000 transactions with time and date stamps.

## Main Menu Variables

Main Menu Variables	Default Units	Variable Type
Net Volume	L	Total
Net Flowrate	L/min	Rate
Main Line Volume	L	Total
Main Line Flowrate	L/min	Rate
Process Line Volume	L	Total
Process Line Flowrate	L/min	Rate
Process Volume Ratio	%	Rate
Process Flowrate Ratio	%	Rate
Process Control Output	%	Rate
Process Flowrate Deviation	%	Rate

Refer to [Available Units of Measurement](#) on page 86 for the list of available units.

## Communications

There are two communication ports available as follows:

- RS-232 port
- RS-485 port (optional)

The ports are available for remote data reading, printouts and for initial application loading of the instrument.

## Isolated Outputs

The opto-isolated outputs can retransmit any main menu variable. The type of output is determined by the nature of the assigned variable. Totals are output as pulses and rates are output as 4-20mA signals. One output is standard, a second output is available as an option.

## Relay Outputs

The relay outputs 1 and 2 are used to control the flow of product for each delivery. These contacts are normally open and can be used to drive external relays, valves, pump circuits etc. The advanced option provides another two relays that can be used as fully programmable alarms for any rate type variable.

## Software Configuration

The instrument can be further tailored to suit specific application needs including units of measurement, custom tags, second language or access levels. A distributor can configure these requirements before delivery.

Instrument parameters including units of measurement can be programmed in the field, according to the user access levels assigned to parameters by the distributor.

All set-up parameters, totals and logged data are stored in non-volatile memory with at least 30 years retention.

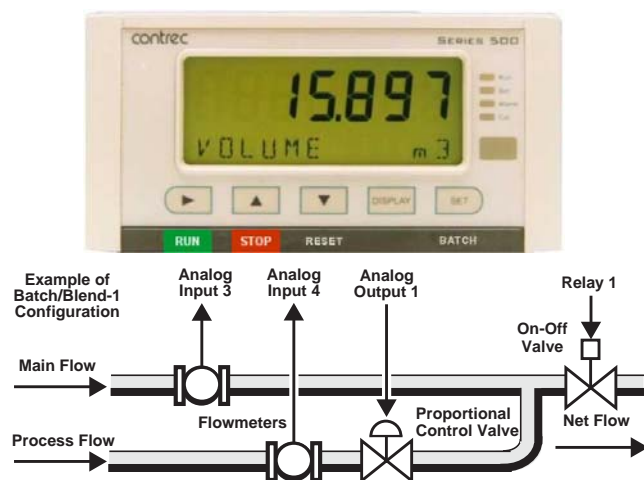

Figure 1 Typical Application Diagram

## Approvals

This instrument conforms to the EMC-Directive of the Council of European Communities 2014/30/EU, the LVD safety directive 2014/35/EU and the following standards:

- *EN61326:2013* Electrical equipment for measurement, control and laboratory use – EMC requirements: Industrial Environment.
- *EN61010:2010* Safety requirements for electrical equipment for measurement, control, and laboratory use.

In order to comply with these standards, the wiring instructions in **Chapter 3 - Installation** must be followed.

### **FCC Declaration**

This equipment has been tested and found to comply with the limits for a Class A digital device, pursuant to Part 15 of the FCC Rules. These limits are designed to provide reasonable protection against harmful interference when the equipment is operated in a commercial environment. This equipment generates, uses, and can radiate radio frequency energy and, if not installed and used in accordance with the instruction manual, might cause harmful interference to radio communications. Operation of this equipment in a residential area is likely to cause harmful interference, in which case the user will be required to correct the interference at his own expense.

Properly shielded and grounded cables and connectors must be used in order to meet FCC emission limits. Contrec Ltd is not responsible for any radio or television interference caused by using other than recommended cables and connectors or by unauthorized changes or modifications to this equipment. Unauthorized changes or modifications could void the user's authority to operate the equipment.

This device complies with Part 15 of the FCC Rules. Operation is subject to the following two conditions: (1) this device might not cause harmful interference, and (2) this device must accept any interference received, including interference that might cause undesired operation.





# Chapter 2

## Specifications

### Specification Table

Operating Environment	
<b>Temperature</b>	-20°C to +60°C (conformal coating) +5°C to +40°C (no coating)
<b>Humidity</b>	0 to 95% non condensing (conformal coating) 5% to 85% non condensing (no coating)
<b>Power Supply</b>	100-240 V AC (+/-10%) 50-60 Hz (+/-10%) or 12-28 V DC
<b>Consumption</b>	6W (typical)
<b>Protection</b>	Sealed to IP65 (Nema 4X) when panel mounted
<b>Dimensions (panel option)</b>	147mm (5.8") width 74mm (2.9") height 167mm (6.6") depth

Display	
<b>Type</b>	Backlit LCD with 7-digit numeric display and 11-character alphanumeric display
<b>Digits</b>	15.5mm (0.6") high
<b>Characters</b>	6mm (0.24") high
<b>LCD Backup</b>	Last data visible for 15min after power down
<b>Update Rate</b>	0.3 second

Non-volatile Memory	
<b>Retention</b>	> 30 years
<b>Data Stored</b>	Setup, Totals and Logs

Approvals	
<b>Interference</b>	CE compliance
<b>Enclosure</b>	IECEX, ATEX and CSA approved enclosures available for hazardous areas

Real Time Clock (Optional)	
<b>Battery Type</b>	3 volts Lithium button cell (CR2032)
<b>Battery Life</b>	5 years (typical)

Analog Input (General)	
<b>Overcurrent</b>	100mA absolute maximum rating
<b>Update Time</b>	< 1.0 sec
<b>Configuration</b>	4-20mA, 0-5V and 1-5V input
<b>Non-linearity</b>	Up to 20 correction points (some inputs)

4-20mA Input	
<b>Impedance</b>	100 Ohms (to common signal ground)
<b>Accuracy</b>	0.05% full scale (20°C) 0.1% (full temperature range, typical)

0-5 or 1-5 Volts Input	
<b>Impedance</b>	10MOhms (to common signal ground)
<b>Accuracy</b>	0.05% full scale (20°C) 0.1% (full temperature range, typical)

Logic Inputs	
<b>Signal Type</b>	CMOS, TTL, open collector, reed switch
<b>Overvoltage</b>	30V maximum

Relay Output	
<b>No. of Outputs</b>	2 relays plus 2 optional relays
<b>Voltage</b>	250 volts AC, 30 volts DC maximum (solid state relays use AC only)
<b>Current</b>	3A maximum

Communication Ports	
<b>Ports</b>	RS-232 port RS-485 port (optional)
<b>Baud Rate</b>	2400 to 19200 baud
<b>Parity</b>	Odd, even or none
<b>Stop Bits</b>	1 or 2
<b>Data Bits</b>	8
<b>Protocols</b>	ASCII, Modbus RTU, Printer*

Transducer Supply	
<b>Voltage</b>	8 to 24 volts DC, programmable
<b>Current</b>	70mA @ 24V, 120mA @ 12V maximum
<b>Protection</b>	Power limited output

### Isolated Output

<b>No. of Outputs</b>	1 configurable output (plus 1 optional)
<b>Configuration</b>	Pulse/Digital or 4-20mA output

### Pulse/Digital Output

<b>Signal Type</b>	Open collector
<b>Switching</b>	200mA, 30 volts DC maximum
<b>Saturation</b>	0.8 volts maximum
<b>Pulse Width</b>	Programmable: 10, 20, 50, 100, 200 or 500ms

### 4-20mA Output

<b>Supply</b>	9 to 30 volts DC external
<b>Resolution</b>	0.05% full scale
<b>Accuracy</b>	0.05% full scale (20°C) 0.1% (full temperature range, typical)

*Important: Specifications are subject to change without notice.  
Printer protocol is available only if RTC option is installed.*

# Chapter 3

## Installation

---

### Panel Mounting

The instrument should be located in an area with a clean, dry atmosphere that is also relatively free of shock and vibration.

The standard mounting procedure is panel mounting in a cutout that is 139mm wide by 67mm high. Two side clips secure the unit into the panel.

Figure 2 shows the panel mounting requirements for the 500 Series Instrument.

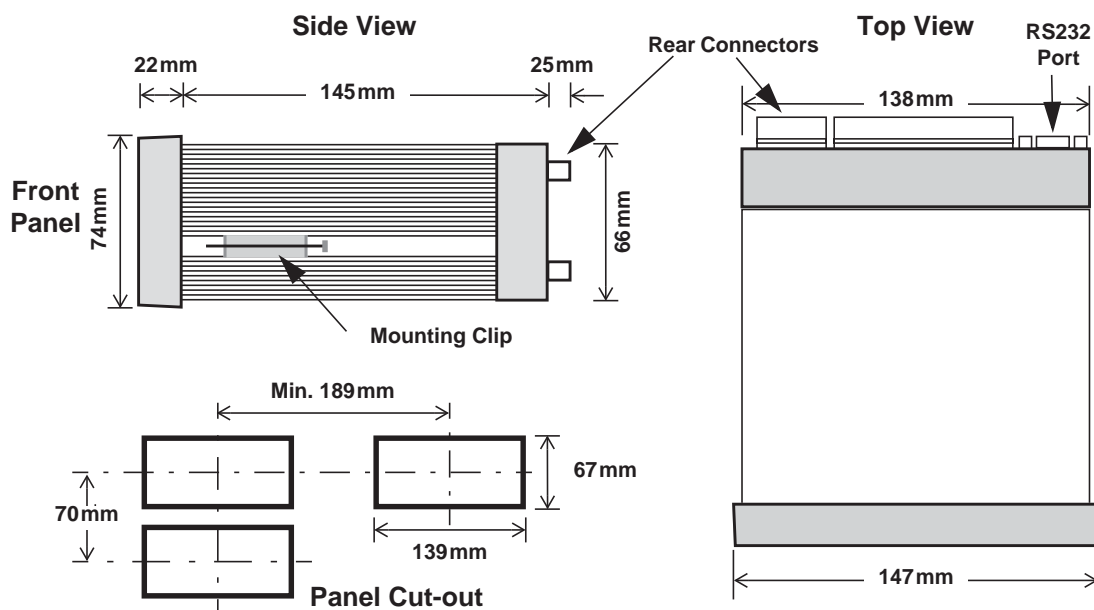

Figure 2 500 Series Instrument Panel Mounting

# Electrical Connection

## Rear Panel Connections

Figure 3 shows the connections on the rear panel of the instrument.

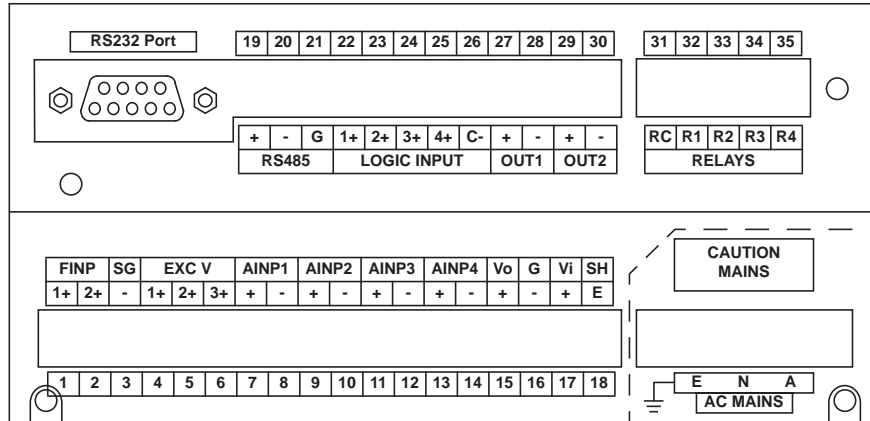

Figure 3 Rear Panel Connections

## Terminal Designations

Terminal Label	Designation	Comment	Terminal Label	Designation	Comment	
1	FINP 1+	Frequency Input 1+	Not used	19	RS485 +	RS485 (+)
2	FINP 2+	Frequency Input 2+	Not used	20	RS485 -	RS485 (-)
3	SG -	Signal ground		21	RS485 G	RS485 ground
4	EXC V 1+	Excitation Term 1+	Not used	22	LOGIC INPUTS 1+	Switch 1
5	EXC V 2+	Excitation Term 2+	Not used	23	LOGIC INPUTS 2+	Switch 2
6	EXC V 3+	Excitation Term 3+	Not used	24	LOGIC INPUTS 3+	Switch 3
7	AINP1 +	Analog Input ch 1 (+)	Not used	25	LOGIC INPUTS 4+	Switch 4
8	AINP1 -	Analog Input ch 1 (-)	Not used	26	LOGIC INPUTS C-	Signal ground
9	AINP2 +	Analog Input ch 2 (+)	Not used	27	OUT1 +	Output ch 1 (+)
10	AINP2 -	Analog Input ch 2 (-)	Not used	28	OUT1 -	Output ch 1 (-)
11	AINP3 +	Analog Input ch 3 (+)	Main Flow Input	29	OUT2 +	Output ch 2 (+)
12	AINP3 -	Analog Input ch 3 (-)		30	OUT2 -	Output ch 2 (-)
13	AINP4 +	Analog Input ch 4 (+)	Process Flow Input	31	RELAYS RC	Relay common
14	AINP4 -	Analog Input ch 4 (-)		32	RELAYS R1	Relay 1
15	Vo +	8-24 volts DC output	Overload protected	33	RELAYS R2	Relay 2
16	G -	DC Ground		34	RELAYS R3	Relay 3
17	Vi +	DC power input	DC power in 12-28V	35	RELAYS R4	Relay 4
18	SH E	Shield terminal			RS232 port	9-pin serial port
E	AC MAINS E	Mains ground	AC power in 100-240VAC			
N	AC MAINS N	Mains neutral				
A	AC MAINS A	Mains active				

# Inputs

## Analog Input Connections

All analog inputs can accept DC signals ranging from 0-5V, 1-5V and current signals from 4 to 20mA.

### CAUTION

Applying levels of input current above the absolute maximum rating (100mA) may cause permanent damage to the input circuitry.

### 0-5 and 1-5 Volt Inputs

For externally powered voltage transmitters, connect each transmitter to a pair of input terminals as shown in Figure 4. Refer to **Terminal Designations** on page 10 for specific terminal numbers for this application.

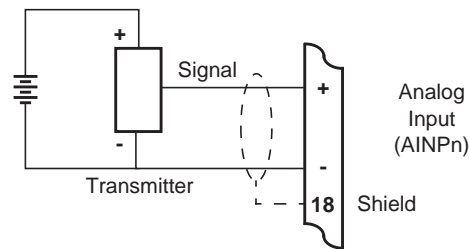

Figure 4 Externally Powered Voltage Transmitter

Connect internally powered voltage transmitters as shown in Figure 5.

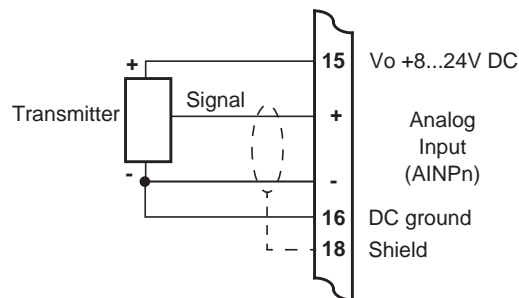

Figure 5 Internally Powered Voltage Transmitter

### 4-20mA Inputs

For externally powered current loops, connect each transmitter to a pair of input terminals as shown in Figure 6. Refer to for specific terminal numbers for this application.

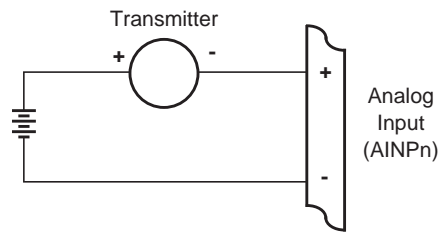

Figure 6 Externally Powered Current Loop

The internal overload-protected power supply has sufficient power for three current loops at 24V DC (more current loops can be supplied by using a reduced voltage setting). Connect internally powered current loops as shown in Figure 7.

Figure 7 Internally Powered Current Loops

## Logic Input Connection

These input(s) are designed to be connected to CMOS, TTL, open collector signals or a voltage free contact switch. A minimum activation time of 300ms is required to guarantee reading of an input.

It is possible to read the status of all the logic inputs via a Modbus register even if they are not used for a control purpose in the application.

A remote push-button key can be connected to the Logic Inputs as shown below. **Logic Input Control** on page 30 describes the function of the inputs.

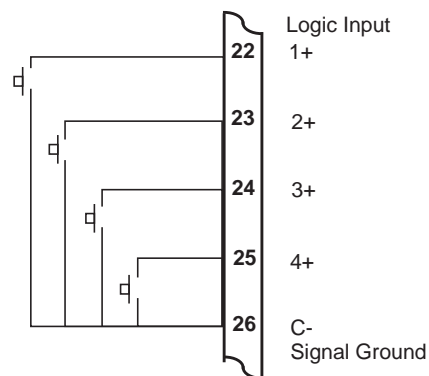

Figure 8 Logic Inputs Connection Diagram

## Outputs

The advanced option for the instrument provides two opto-isolated output ports. Either or both can be used for 4-20mA or pulse outputs.

**CAUTION**

Due to the dual-purpose nature of the outputs, take care not to set the output as an open collector pulse type signal when connected to a 4-20mA loop circuit.

**4-20mA Output Connection**

Figure 9 shows the connections for a 4-20mA output. Output channel 1 uses terminals 27 (+) and 28 (-), output channel 2 uses terminals 29 (+) and 30 (-).

$$\text{Maximum Load Resistance} = (\text{Supply}-9) / 0.02 \text{ ohms}$$

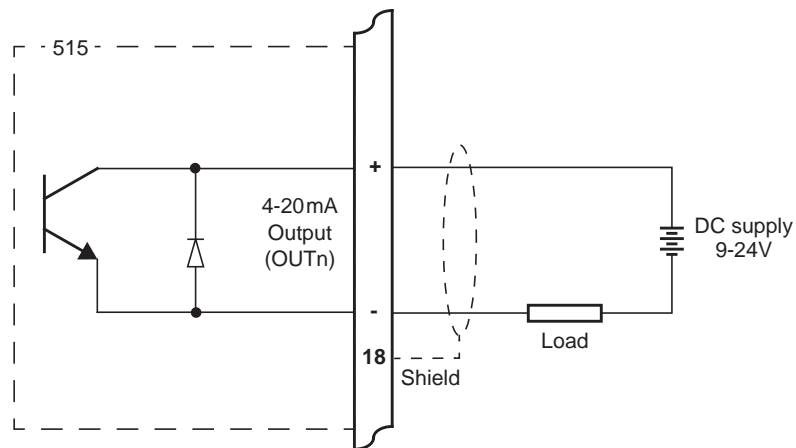

Figure 9 Output 4-20mA Connection Diagram

**Digital Output Connection**

Figure 10 shows a connection example for a pulse output. Output channel 1 uses terminals 27 (+) and 28 (-). Output channel 2 uses terminals 29 (+) and 30 (-).

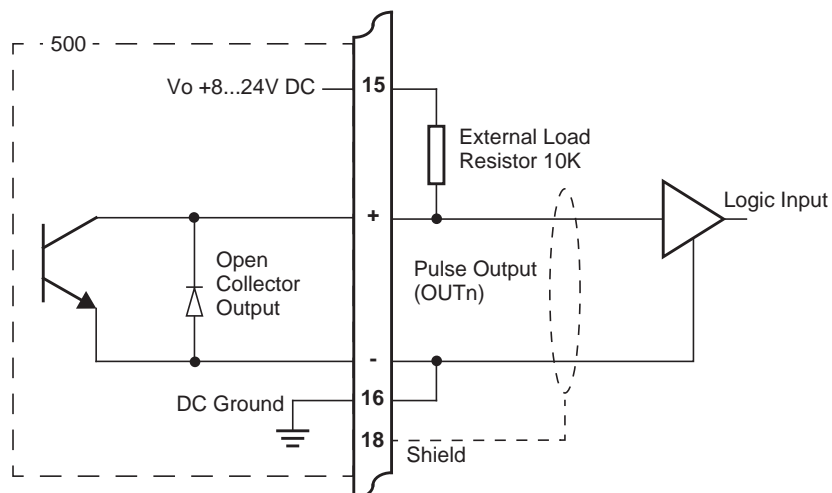

Figure 10 Output Pulse Connection Diagram

## Control Relays (Alarms)

The standard instrument has two relays, which are used for the dual stage batch control. The relays can drive external devices such as valves, pump circuits or external relays.

The advanced option has two extra relays that can be freely assigned as alarm relays. The operation of alarm relay(s) can be set to various modes as described in [Alarms](#) on page 51.

There is also an equipment failure alarm option. This alarm can have normally closed (open) contacts which open (close) when the instrument displays any error message as listed in [Error Messages](#) on page 59, or if there is a loss of power to the instrument.

The output characteristics of the relays are:

Maximum Voltage 30 volts DC or 250 volts AC  
 Maximum Current 3A

**Note:** Solid state relays use AC voltage only.

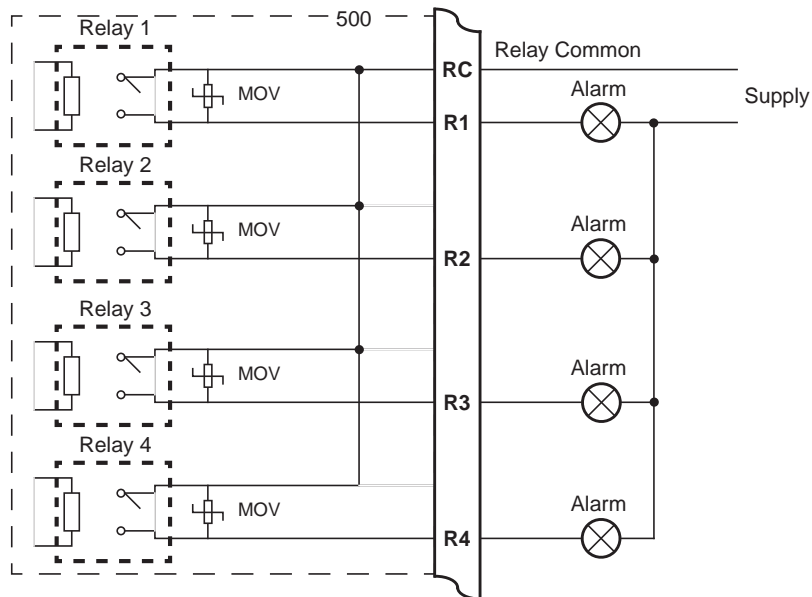

Figure 11 Relay Connection Diagram



## RC Network for Interference Suppression

When driving highly inductive loads with the relay outputs, it is recommended to use RC suppression networks (often called “Snubbers”) for the following reasons:

- To limit the amount of electrical noise caused by arcing across the contacts, which may, in extreme cases, cause the microprocessor to act erratically.
- To protect the relay contacts against premature wear through pitting.

RC suppression networks consist of a capacitor and series resistor and are commonly available in the electrical industry. The values of R and C are dependent entirely on the load. However, if the user is unsure of the type of snubber to use, values of 0.25  $\mu\text{F}$  and 100  $\Omega$  will usually suffice. Note that only mains-approved RC suppression networks should be used.

The basic principle of the operation is that the capacitor prevents a series of sparks arcing across the contact as the contact breaks. The series resistor limits the current through the contact when the contact first makes.

## Communications

The communication protocols are described in [Communications](#) on page 61.

### RS-232 Port

The RS-232 port has a 9-pin DB female connector and has the following pinout:

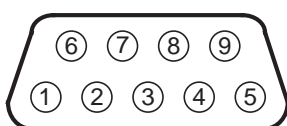

Pin 1	Not used
Pin 2	Transmit (TxD)
Pin 3	Receive (RxD)
Pin 4	Not used
Pin 5	Ground
Pin 6	Not used
Pin 7	Handshake line (CTS)
Pin 8	RTS Out
Pin 9	Not used

**Note:** The instrument does not require a null-modem cable for connection to a personal computer. Refer to **Hardware Interconnection** on page 61 for cable termination requirements.

### RS-485 Port (Optional)

Up to 32 units can be connected to a common RS-485 bus. Each unit has a unique address that the host computer uses to identify each instrument.

Figure 12 shows the connection of several instruments to a computer using the RS-485 port.

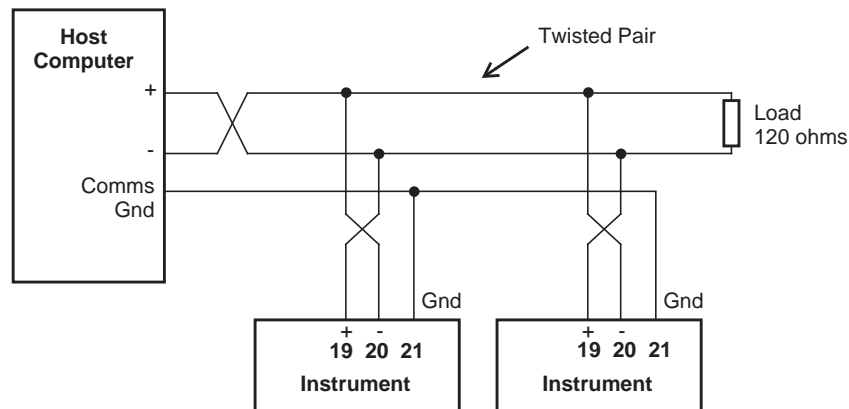

*Figure 12 RS-485 Interface Connections*

### Earthing and Shielding

It is a good practice to use shielded cable for all signal connections to the instrument. Care must be taken to separate signal cables from power cables to minimize interference.

Overall earth should be connected at the instrument end only. This connection should be as short as possible and connected to the earthing point on the rear terminal at pin 18.

# Chapter 4

## Operation

---

### Front Panel Operation

This instrument is a batch controller that is capable of controlling the rate of flow during a delivery. Batch control can be via a PRESET or an ON-OFF mode, while process flow control can be via a LOCAL (manual) or LOOP/RATIO/BLEND (PI control) mode. The controller can be used in any combination of these modes to achieve the required functionality.

This instrument can also be programmed to display operator prompts to accept a permissive signal before a delivery or batch can be commenced.

In normal operation, press the buttons on the front panel to control the operation of the batch controller or to display the values recorded and calculated by the instrument.

There are several categories of information that the instrument can display:

- Totals
- Rates
- Batch preset values
- Flow control values
- Instrument settings

For each total, there is an associated rate as follows:

<b>Total</b>	<b>Rate</b>
Net Volume	Net Flowrate
Main Line Volume	Main Line Flowrate
Process Line Volume	Process Line Flowrate

## Default Variable

In some applications, a particular variable is of more interest than others, and for this reason a default variable can be assigned during instrument calibration. The default variable is used in the following ways:

- Determines what the display returns to when the Stop key is pressed while viewing other items in the main menu list.
- Determines what the display returns to if the display timeout option is enabled and no buttons are pressed for the selected period (usually 30 seconds).
- Determines what is displayed on power up or exit of Calibrate mode.

## Status LEDs

The status LEDs illuminate to show the following conditions:



- Run** Solid led: The instrument has a batch in progress.  
 Fast flashing led: Batch paused.  
 Slow flashing led: Waiting for valves to close.
- Set** Solid led: The instrument is in Calibrate Set mode.  
 Flashing led: Count down to automatic restart of next batch.
- Alarm** The instrument has an error, as indicated on the display panel.
- Cal** The instrument is in Calibrate View mode.

## Front Panel Keys

**RUN** Press the **RUN** key to start or resume a batch. The run led will illuminate.

**STOP** Press the **STOP** key to halt a current batch. The instrument will go into pause mode and the run led will flash at a steady pace. The incomplete batch can be resumed or the **STOP** key can be held again to end the batch and the run led will turn off. The **STOP** key is also used to stop the next batch if in automatic restart count down, can be used to return the display directly to the default variable (total) when scrolling through the main menu items and can be used to acknowledge flow errors without resetting the total.

**RESET** Use the **RESET** key to step directly to the HOLD.SET - TO RESET prompt within the main menu items. Holding SET at this point will clear the batch totals or the **DISPLAY** key can be pressed to step onto the HOLD.SET - TO PRINT prompt if the printer option has been selected.

The instrument makes three beeps when it resets the totals and two beeps when a printout is started.

**DISPLAY** Press the **DISPLAY** key to step or scroll through the main menu items.

**BATCH** Hold the **BATCH** key to display the current batch preset value. Continue to hold for two seconds to enter edit mode for the preset if access is authorised. Pressing the **BATCH** key briefly displays the accumulated total.

## Main Menu Items

The main menu in this instrument consists of the following items. The **DISPLAY** key is used to step or scroll through the list. The full menu can only be viewed if the batch controller has been stopped and reset .

<div style="border: 1px solid black; padding: 2px; display: inline-block;">DISPLAY</div> ↓	Description	Options
N-VOL	Net volume	Hold the <b>SET</b> key to display (or edit) the batch preset or briefly press to view the accum total
N-FLOW	Net flowrate	Hold the <b>SET</b> key to display peak value
M-VOL	Main line volume	Hold the <b>SET</b> key to display accumulated total
M-FLOW	Main line flowrate	Hold the <b>SET</b> key to display peak value
P-VOL	Process line volume	Hold the <b>SET</b> key to display accumulated total
P-FLOW	Process line flowrate	Hold the <b>SET</b> key to display (or edit) the controlling setpoint
R-VOL	Process volume ratio	Hold the <b>SET</b> key to display (or edit) the controlling setpoint
R-FLOW	Process flowrate ratio	Hold the <b>SET</b> key to display (or edit) the controlling setpoint
P-CTRL	Process control output	Hold the <b>SET</b> key to display (or edit) the controlling setpoint
DEVIAT	Process flowrate deviation	Hold the <b>SET</b> key to display (or edit) the controlling setpoint
TO RESET		Hold the <b>SET</b> key to manually reset the current delivery (batch) total.
TO PRINT	Only shown if print option is selected	Hold the <b>SET</b> key to manually print a delivery docket.
REPORT PRINT	Only shown if print option is selected	Hold the <b>SET</b> key to print log report as defined in the TM/LOG section of calibration.
LOGGED DATA	Only shown if real-time clock option is installed	Hold the <b>SET</b> key to display data logs as described in <b>Data Logs</b> on page 20.
MODEL INFO		Hold the <b>SET</b> key to display the Model information as described in <b>Model Information</b> on page 22.
CAL MENU		Hold the <b>SET</b> key to enter Calibration View mode as described in <b>Calibration View Mode</b> on page 35.

## Setting the Batch Preset

**SET** The batch preset can only be set while the instrument is in the non-operational state, i.e. batch is complete or has been stopped and reset. Hold the **SET** key to display the current preset value while viewing the total variable. The display of the preset will change from view mode to edit mode after 2 seconds if access has been enabled in calibration. Once in edit mode the **Set** indicator will illuminate and the preset value can be changed in the same way as in calibration set mode, see [Changing Numeric Settings](#) on page 37. The **SET** key is used to exit edit mode.

### Limit on Batch Size

To prevent accidental entry of large batch quantities, a maximum batch limit can be programmed during calibration. The operator is then prevented from entering a batch quantity which exceeds this value.

### Common Preset Values

If the batching application continually uses a regular set of preset values then quick access can be provided to these. In calibration, there is the opportunity to enter up to 10 commonly used preset values.

These can then be accessed whilst in batch edit mode (described above) by pressing the **DISPLAY** key. The pre-programmed values will appear in the order they were entered in calibration. The display will step through the presets back to the currently entered value which can still be manually edited. While displaying the desired preset value, press the **SET** key to accept the value and exit edit mode.

## Setting the Flow Control Setpoints

**SET** Hold the **SET** key to display (or edit) the controlling setpoint while viewing one of the “rate” variables. The display of the setpoint will change from view mode to edit mode after 2 seconds if access has been enabled in calibration. Edit mode can not be entered if a “Preset” batch is in progress. Once in edit mode the **Set** indicator will illuminate and the setpoint values are changed in exactly the same way as in calibration set mode.

## Data Logs

The instrument will log up to 1000 deliveries (batches) if the real-time clock option is installed. The logs are taken at the end of each batch or upon reset if a batch has been aborted before the preset total has been reached. Each entry has a log number, a delivery number and a time and date stamp.

When the number of log entries exceeds 999 the oldest log entry is overwritten by the newest one.

## View Data Logs

Use the following procedure to view the data that has been logged by the instrument:

1. Press the **DISPLAY** key to scroll through the menu to the **LOGGED DATA** prompt.
2. Hold the **SET** key.

The system displays the most recent log record first. The log record number and corresponding delivery number are shown, for example LR-001 and DEL 1236.

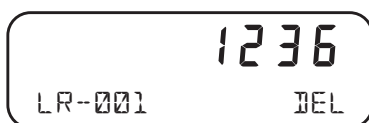

3. Use the **▲** or **▼** keys to scroll to the delivery number or log record of interest.
4. Press the **DISPLAY** key to show the information stored in the selected log record. Each log record consists of:
  - time and date stamp,
  - error code
  - totals for the delivery.
5. While holding the **DISPLAY** key use the **▶** key to step through the stored information.
6. While holding the **DISPLAY** key use the **RESET** key to print the data for the displayed log if the printer option has been selected.

The following example shows the format of the time and date stamp at 15:25 (3:25 pm) on 16 January 2016. The day and month alternate with the year in the bottom right hand corner.



## Model Information

The model information items display the hardware, software and application versions of the instrument. This information is mainly for service personnel. Typical examples are shown below.

DISPLAY ↓	Description
2-1--5- 515 MODEL	The hardware model information. Refer to <b>Product Codes</b> on page 83 for full information.
-F--LH BR02 INPUT	The Application number and the assignment of the inputs. Refer to <b>Application Information Code</b> on page 84 for more information.
3.0.000 500PM VERS	The version of 500-Series Program Manager from which the application software was compiled.
026357 CUSTOM VERS	The Customer version code for this installation. Refer to <b>Custom Version Codes</b> on page 84 for more information.
123456 ABC123 S/N	The instrument serial number and unit tag. The serial number is on the top line and unit tag is on the bottom left. Both items are entered when the instrument application software is initially loaded. If the unit tag is not used the default tag, UNIT, will be used.
16-15 EDITED 27/08 2016	The time and date when the calibration of the instrument was last edited. The format of the time and date is the same as for the data logs. This example shows 16:15 (4:15pm) on the 27th August 2016.  This function is available only if the instrument has the real time clock option.

Press **SET** at any time to exit from the Model information.

## Flow Control Modes

This instrument can operate in several process control modes including:

- Local (manual) mode
- Loop mode
- Tune mode (only available in calibration set mode)
- Ratio mode
- Blend-1 mode (for blending point after main flowmeter)
- Blend-2 mode (for blending point after main flowmeter)



In all of these modes, except Blend-2, the Net flow is the combination of the Main and Process flows. In Blend-2 the Main flow equals the Net flow.

### Local Mode

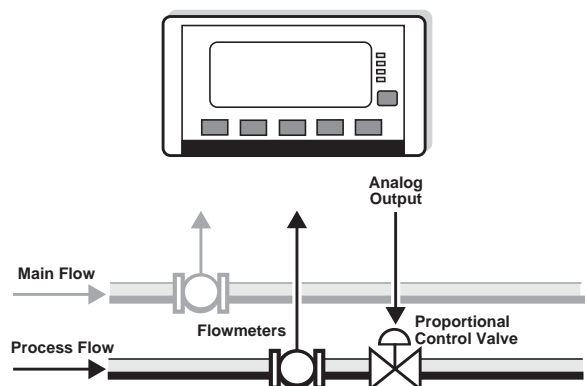

The desired process control output (P-CTRL %) is manually set via the front panel or serial communications.

The output signal is used to drive the proportional control valve to the desired position.

The control of the process line is independent of the main flow.

### Loop Mode

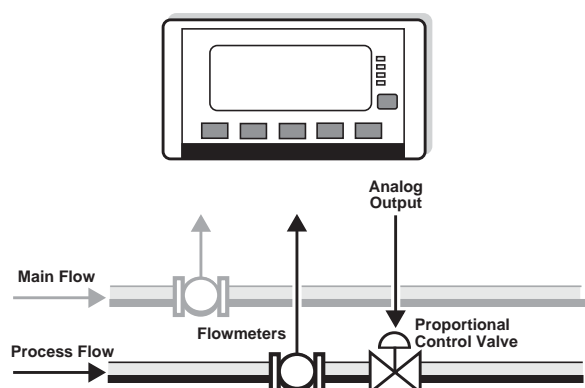

The desired process flowrate set point (P-FLOW SP) is set via the front panel or serial communications.

The PI controlled output signal is used to maintain the desired process flowrate via the proportional control valve.

The control of the process line is independent of the main flow.

**Tune Mode - CAL MODE ONLY**

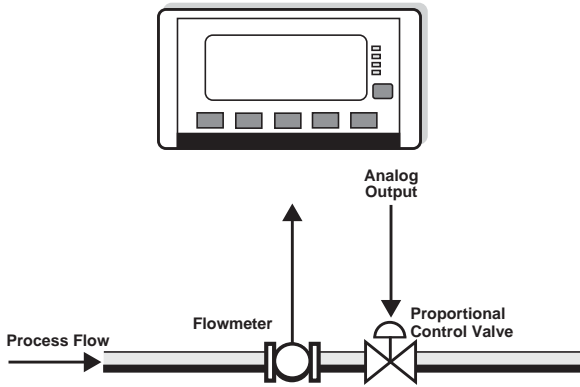

This mode is only accessed from within calibration mode and allows the operator to view a concise list of key parameters and gain immediate feed back. The Proportional Band (P-BAND) and Integral Time (I-TIME) are entered to tune the system.

For details on this method see below: **”Tuning the Control Loop”**.

The control and tuning of the process line in this mode is independent of the main flow.

**Ratio Mode**

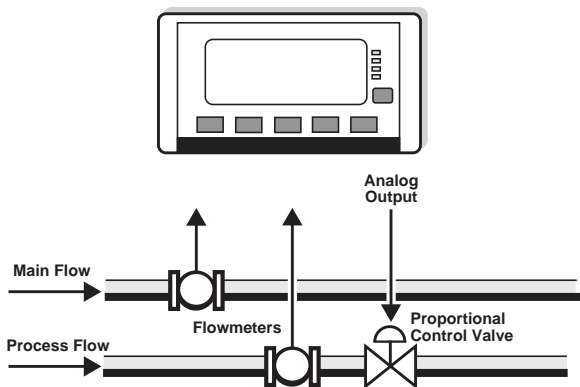

The desired process ratio set point (RATIO %) is set via the front panel or serial communications.

The PI controlled output signal is used to maintain the desired process flowrate via the proportional control valve.

The desired process flow is determined as a ratio of the main flow (0 to 400% range) i.e.

$$Ratio\% = \frac{P_{flow}}{M_{flow}} \times 100$$

**Blend-1 Mode**

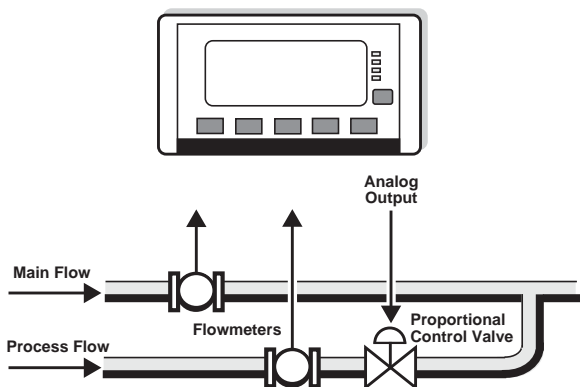

The desired blending ratio set point (RATIO %) is set via the front panel or serial communications.

The PI controlled output signal is used to maintain the desired process flowrate via the proportional control valve.

The desired process flow is determined as a ratio of the net (combined) flow (0 to 80% range). i.e.

$$Ratio\% = \frac{P_{flow}}{M_{flow} + P_{flow}} \times 100$$

## Blend-2 Mode

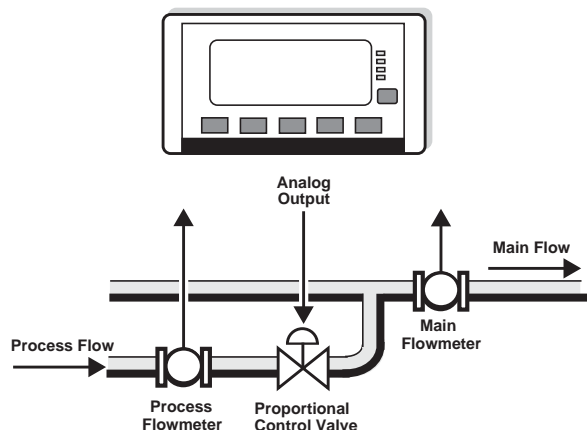

The desired blending ratio set point (RATIO %) is set via the front panel or serial communications.

The PI controlled output signal is used to maintain the desired process flowrate via the proportional control valve.

The desired process flow is determined as a ratio of the main (net) flow (0 to 80% range). i.e.

$$Ratio\% = \frac{P_{flow}}{M_{flow}} \times 100$$

## Tuning the Control Loop

The Process Controller has a special control mode, within the Parameters section of calibration, to assist in tuning the control loop. This mode provides a concise list of key parameters and allows for immediate feedback. The basic principle in tuning the loop is to gradually adjust the Proportional Band (P-BAND) and the Integral Time (I-TIME) and observe the response to a step change in the setpoint.

The tune menu provides for this by allowing the P-BAND and I-TIME to be programmed and then a Process Flow (P-FLOW) setpoint value to be entered. The next items in the menu are the actual live process variable and the deviation from the target value, so that the response of the system to a setpoint change can be observed. Unless the menu is quit the program will step back to start of the tuning menu so that new values of P-BAND and I-TIME can be entered and the effect of a step change in the setpoint be monitored.

As the idle position for any On-Off control valve in a batching system is “closed”, a special option in the Batch Mode parameter, RELEASE, allows the valve to be opened from within calibration. For more information, refer to **Release Mode** on page 27.

This sequence is used for Loop mode. The tuning procedure is as follows:

1. Before tuning the control loop it is essential to program in the correct parameters for the flowmeters, including filtering.
2. The actual Process Flow Range (P-FLOW RANGE) should be measured and entered. It is determined by setting the Control Mode to LOCAL, Batch Mode to RELEASE, setting the *Flow Setpoint* (control output) to 100% (20mA) and then observing the steady state flowrate.
3. With the correct Process Flow Range entered and Batch Mode still set to RELEASE the Control Mode should now be set to LOOP to continue the tuning procedure.
4. With the Loop Error Deadband (D-BAND) and the Output Ramp Time (R-TIME) set at zero, the I-TIME should be set to zero (disabled) and the P-BAND set at 150%.

Gradually decrease the P-BAND value until the system begins to oscillate when a small step change of the setpoint is introduced. When this occurs, double the value of the P-BAND.

5. Next set the I-TIME to 20 seconds and gradually decrease the value until the system again begins to oscillate when a small step change of the setpoint is introduced. When this occurs double the value of the I-TIME.
6. The Deadband and the Output Ramp Time can now be programmed as required.

The system should be tuned around the flowrate at which the eventual system will operate. The stability of the loop should then be checked at various flowrates and setpoints.

## Batch Operation Modes

This instrument can operate in the following Batch operation modes:

- PRESET
- ON-OFF
- RELEASE (only available in calibration set mode)

### Preset Mode

If the batch mode is **PRESET** the prestop and shut-off points are determined by the instrument.

A slow flow start feature is available for smoother batching. The automatic overrun compensation feature can be used to improve accuracy and repeatability. An auto-restart feature for automated repeat batches is also available in preset mode.

## On-Off Mode

If the batch mode is **ON-OFF** the shut-off point is determined by the operator.

The slow flow start feature can still be used, but in this mode starting and stopping is determined by the operator and in this mode there is no End of batch output signal.

## Release Mode

The **RELEASE** prompt in batch mode is used to open the On-Off control valve from within calibration, primarily for tuning and commissioning purposes.

The RUN led is illuminated while the On-Off valve is “open”. The type of flow control while the valve is open is dependent on the control mode at the time. If in LOOP mode PI Loop flow control is activated.

For PI Loop tuning procedures that may need the flow to be “released” for a considerable time it is important that the flow is directed to an appropriately sized vessel.

If calibration is exited while in RELEASE mode the On-Off valve will close and the batch mode will default to PRESET mode.

# Batch Operation

## Operation Configurations

For batch control this instrument can be used in various configurations:

### Typical Single Stage Batching Configuration

#### Flow Control & 1 Relay

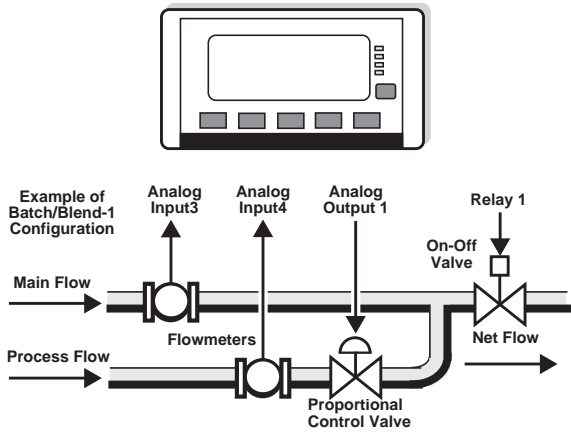

The Hold Output feature can be used in this configuration to provide a faster return to the desired flowrate when the next batch is started.

The analog flow control output can be used to operate either a proportional control valve or a variable speed drive.

### Typical Dual Stage Batching Configuration

#### 2-Stage Relay Control

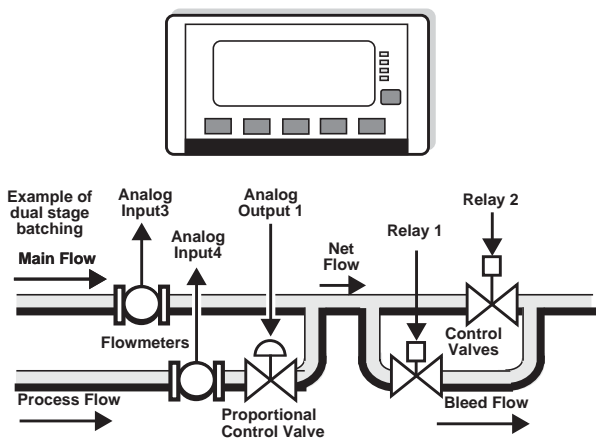

The batch controller can also be used in a conventional dual stage configuration.

Parameters for slow start and prestop points are provided to control the operation of Relay 2.

A digital output can be programmed as a pump control signal if required.

## Safety and Security

Before a batch or delivery can be commenced it may be imperative that certain safety or security measures are in place. Interlocks, grounding connections, secure keys and identification devices can be used to prevent untrained or unauthorised personnel from operating the batch controller.

### Connecting a Permissive

If this feature has been enabled, the Permissive Input on logic input 4 ensures that a closed circuit to the common terminal (0 volts) must exist before a delivery can be started. A batch will not continue if the permissive input is removed and can not be resumed until the permissive input is restored. A prompt to 'Connect Permissive' is scrolled on the display if the permissive circuit is not closed.

The Permissive Input feature can be enabled or disabled within the Parameters section of calibration.

## Starting a Batch

The delivery (batch) will start when the **RUN** key is pressed. The RUN led will illuminate and the instrument will begin to totalise from zero.

The batch controller's analog output and two relays can be used to control the delivery of product. These are energised and de-energised as described below.

## Stopping a Batch

The delivery (batch) can be stopped at any time by pressing the **STOP** key. Once the process has been interrupted in this way it can be continued by pressing the **RUN** key or the batch can be stopped completely by holding the **STOP** key until the run led turns off.

When the process is in pause mode, the RUN led will flash to prompt the operator to restart or abort the batch.

## Resetting a Batch

The instrument can be programmed to reset by different means.

- After the end of a batch, the **RESET** key can be pressed to step directly to the HOLD.SET - TO RESET prompt in the main menu list. Holding the SET key at this point will reset the batch total.
- If Auto Reset is enabled in the parameters section of calibration, the batch total will automatically reset when the next delivery (batch) is started.

## Logic Input Control

This instrument allows for remote operation via the logic inputs on the rear terminals. The logic input have the following functions:

- Logic Input 1 - Remote Run
- Logic Input 2 - Remote Stop/Reset
- Logic Input 3 - Reserved
- Logic Input 4 - Permissive Input

The Remote Stop input can also be used to reset the batch total by holding the logic input low for 2 seconds if the batch is already complete.

For connection details, refer to [Logic Input Connection](#) on page 12.

## Batch Flow Errors

The instrument has the ability to raise an alarm when it detects a loss of flow, a quadrature input error, an unexpected/overflow or a leakage in the system.

- **No Flow Error** - The no flow condition is detected when the flow timeout expires during a delivery. There must not be a period of no flow greater than the timeout value during the delivery.
- **Unexpected/Over Flow Error** - The overflow condition is detected when the flow continues longer than the timeout period after the controller has attempted to stop (or pause) the flow.
- **Leakage Error** - The leakage condition is detected when an amount greater than the acceptable total is received without flow being initiated by the batch controller.

The point at which these errors are detected is dependant on the values programmed into the calibration parameters such as Batch Flow Timeout and Acceptable Total. The open collector outputs can be assigned to activate whenever one of the flow errors occur. Refer to [Instrument Settings](#) on page 40 for more details.



A 'No Flow' or 'Unexpected/Over Flow' error can be cleared by pressing the **STOP** key without resetting the totals. A paused batch may be restarted or the delivered total remain until a reset action is carried out.

If logging and/or printing is enabled, the highest priority Error/Exception that occurred during the batch will be included as part of the recorded data. Refer to **Error Messages** on page 59 for details on the order of priority.

## Batch Control Processes

The batch controller can be programmed to operate in various ways including:

- Manual Reset (manual start).
- Automatic Reset (manual start).
- Automatic Restart for continuous batches (PRESET mode only).

In each of the above modes and configurations the parameters can be programmed to determine the behaviour and timing of relays and output signals. The following figures provide examples of some batch operations. Refer to **Instrument Settings** on page 40 for more details.

### Manual and Automatic Reset

If Manual Reset the **RESET** key must be pressed at the end of the batch to clear the batch total. This must be done before another batch can be started. If Automatic Reset is programmed, a new batch is commenced each time the **RUN** key is pressed.

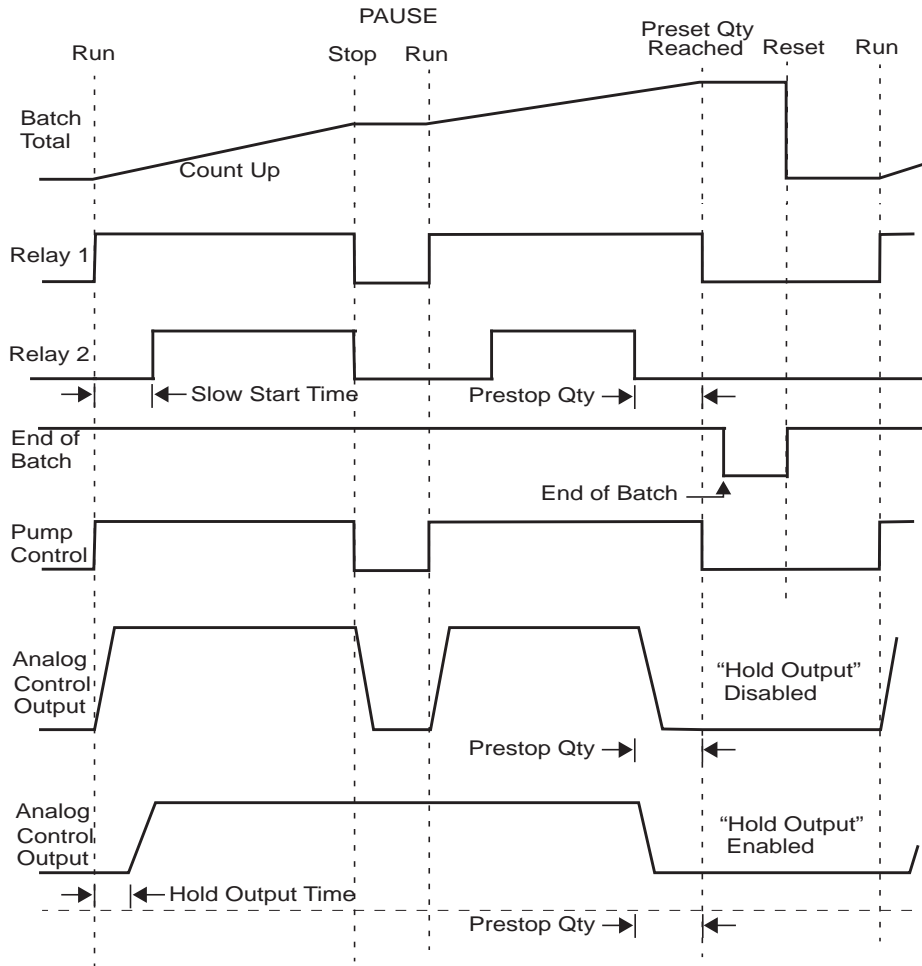

Figure 13 Batch Operation with Manual or Automatic Reset

### Automatic Restart

If Automatic Restart is enabled the next batch will commence automatically when the restart timer expires after the end of batch has occurred. The SET led will flash while the instrument is waiting to automatically restart.

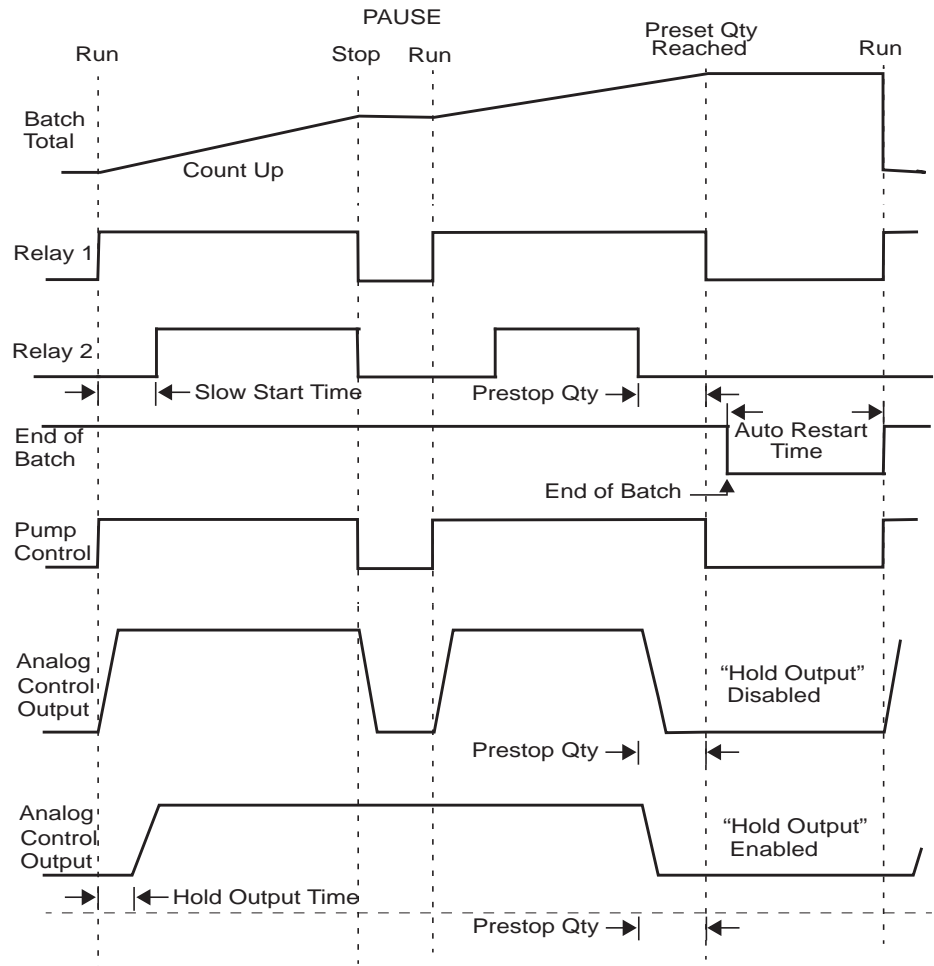

Figure 14 Batch Operation with Automatic Restart



# Chapter 5

## Instrument Calibration

---

### Introduction

You can view or change the settings of the instrument according to the access level for each parameter as set by the manufacturer. There are four levels of access to the parameters as follows:

- **Not visible** - you cannot display or edit the parameter.
- **Display Only** - you can display the parameter, but you cannot change the setting.
- **Programmable** - you can change the setting of the parameter in Calibration Set mode.
- **Password protected** - you can change the setting of the parameter in Calibration Set mode only if you enter the correct password.

**Note:** When you enter Calibration Set mode, the instrument requests you to enter a password. Any value will allow to change the settings of the “programmable” parameters, but the correct password must be entered to change the password-protected parameters.

### Calibration View Mode

Use the following procedure to view the calibration settings of the instrument:

1. Press **DISPLAY** to scroll to the **CFM MENU** prompt.
2. Hold the **SET** key.



The instrument beeps once, illuminates the **Cal** indicator and shows **CFM** on the display panel.

- Press **▶** to scroll through the flashing menu headings.
  - Press **SET** to scroll through submenu items.
  - Press **DISPLAY** to return to the main calibration menu.
3. To exit from the Calibration View mode, press **▶** to scroll to the **END** option and press **SET**.

The instrument returns to Normal Operation mode.

# Calibration Set Mode

In Calibration Set mode, you can change the settings of the “programmable” parameters. You must enter the system password to change the setting of the “password-protected” parameters.

Use the following procedure to enter Calibration Set mode:

1. Press **DISPLAY** to scroll to the **FL MENU** prompt.
2. Hold the **SET** key.



The instrument beeps once, illuminates the **Cal** indicator and shows **FL** on the display panel.

3. Press **▶** to select any flashing menu heading except **END**.
4. Hold **SET** for two seconds.

The instrument requests a password.

5. Press **▲** or **▼** to change the value of the current digit. To select the next digit, press **▶**.
6. Press **SET** to accept the password.

- The instrument makes two beeps for a correct password entry and enables you to change the “programmable” and “password-protected” parameters.
- The instrument makes one beep for an incorrect password entry and enables you to change only the “programmable” parameters.



The instrument illuminates both the **Cal** and **Set** indicators.

7. Edit the instrument parameters as required. The programmable values are indicated by the flashing display.
  - To change a numerical value, press **▲** to increase a value, or press **▼** to decrease a value. Press a key momentarily to change the value one number at a time. Hold a key to scroll through the numbers. To proceed to next digit, press **▶**.
  - To change an option setting, press **▲** or **▼** to scroll through the options.
8. Press **SET** to accept the currently displayed value and proceed to the next parameter. You can press **DISPLAY** to return to the main calibration menu.
9. To exit from Calibrate Set mode, press **▶** to scroll through the main calibration menu to **END**, then press **SET**. Otherwise, from any menu, you can press and hold **SET** for two seconds.



The instrument makes two beeps and cancels the **Cal** and **Set** indicators.

## Changing the Instrument Settings

In Calibration Set mode, the display flashes the item that can be changed. For option settings, the display flashes the complete option. For a numeric parameter, the display flashes one digit at a time, you can change the value of the flashing digit as required, then move the flashing cursor to change another digit.

**Note:** When you change the setting of a parameter, the instrument records the result as soon as you move to another parameter, or exit from the Calibration Set mode.

### Changing Option Settings

When you display an option that can be changed, the entire option flashes on the display, such as the choices of ODD, EVEN or NONE for the communications parity bit checking. Press  or  to change the option. You can “scroll” through the options in either direction to make a selection as shown below.

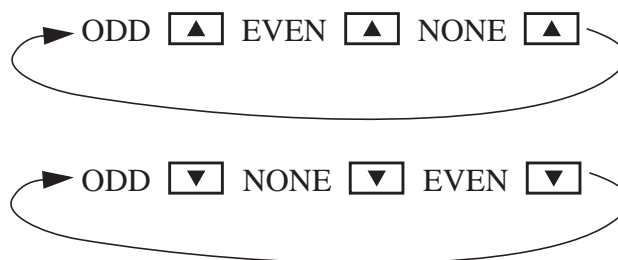

### Changing Numeric Settings

The display flashes the digit that can be changed.



Press  to select the digit that you wish to change.

Press  or  to increase or decrease the value of the selected digit.

### Changing the Decimal Point

To change the position of the decimal point, press  to move the flashing selection until the decimal point flashes. Press  or  to move the decimal point to the right or left as required.

### Units of Measurement

The calibration of some parameters is based on the units that are defined for the relevant variables. These units of measurement can be viewed in the UNITS menu in calibration below.

# Calibration Menu Tree

Figure 15 and Figure 16 show the keys for moving around the calibration menu tree in Calibration View or Set mode.

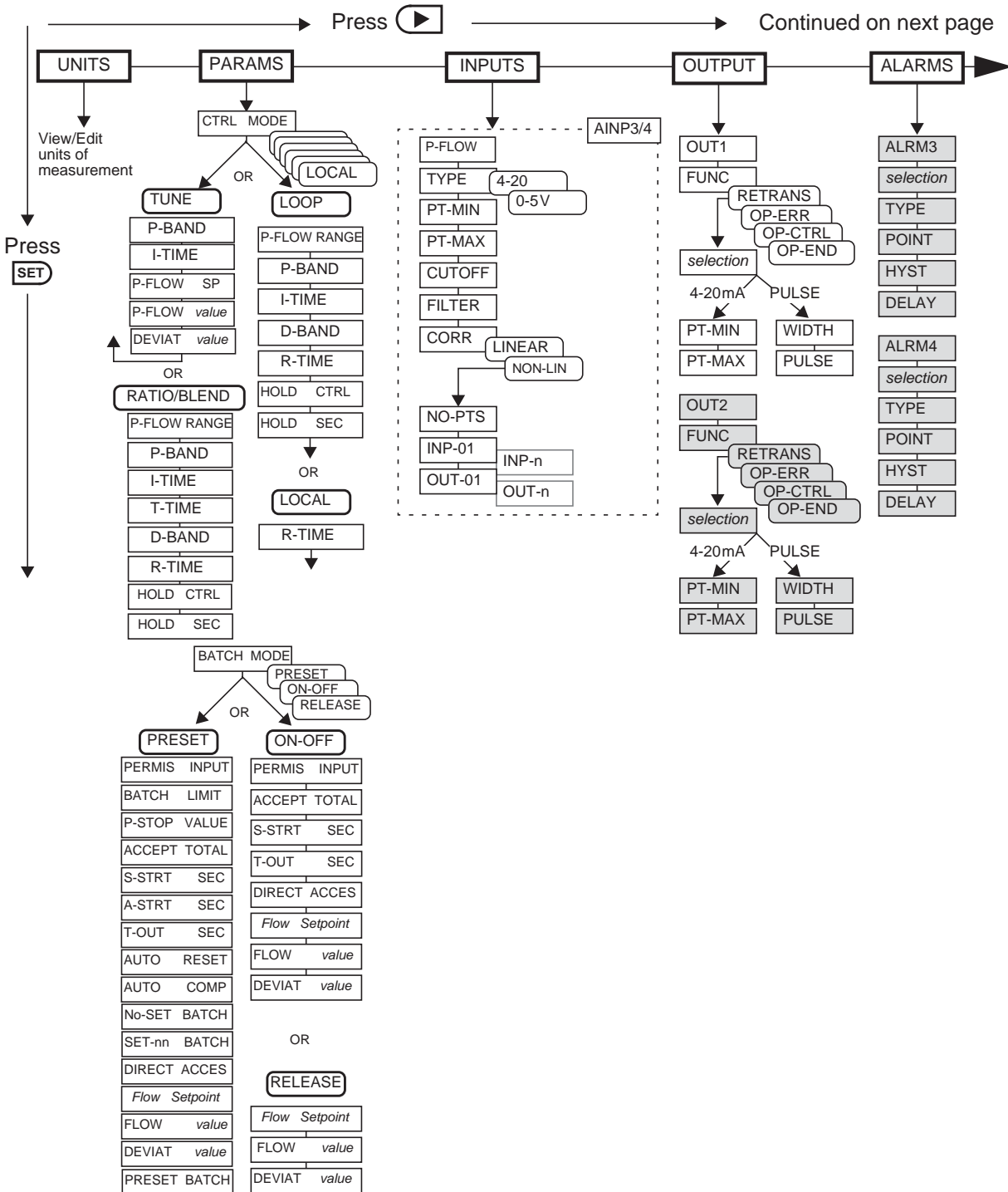
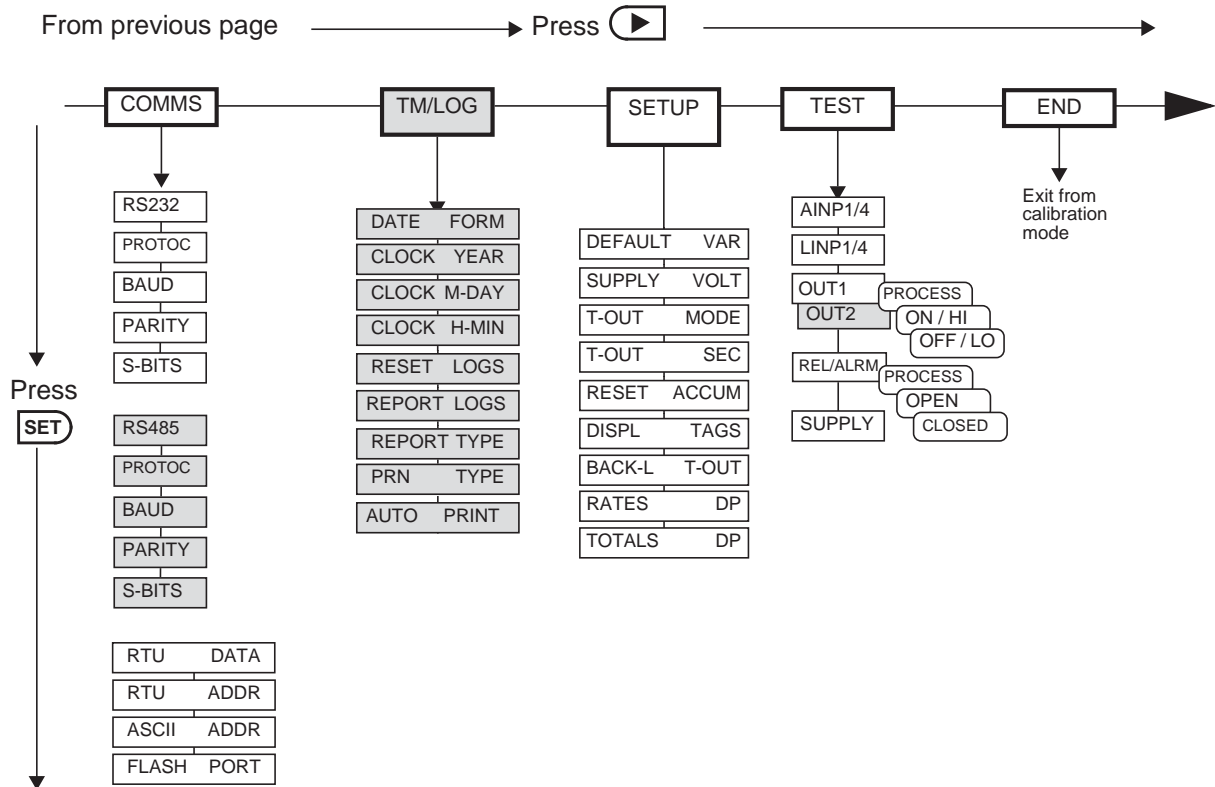

Figure 15 Calibration Menu Tree Sheet 1





 The shaded boxes indicate hardware options

Press  at any point to return to the main calibration menu.



Press  at any I/O assignment position to move to the next I/O assignment in the submenu (eg pressing  on ALRM1 will move you to ALRM2 if it exists)

Figure 16 Calibration Menu Tree Sheet 2





# Instrument Settings

## Units of Measurement





The Units menu allows the units to be viewed and edited if necessary without the reloading of new application software. Any change in units will result in a full reset to initially downloaded settings. Therefore, any required changes to units of measurement should be made before changing any other settings.

<p><b>SET</b> ↓</p>	<p>▶ → <b>UNITS</b>    PARAMS    INPUTS    OUTPUTS    ALARMS    COMMS    TM/LOG    SETUP    TEST    END</p>
<p>ITEM <i>n</i>      <i>unit</i></p>	<p>The units for main menu or calibration items can be viewed by pressing the <b>SET</b> key.</p> <p>The units of measurement are password protected. To edit the units the correct password must be entered on entry to EDIT mode.</p> <p>Press ▲ or ▼ to select the required units. Refer to <b>Available Units of Measurement</b> on page 86 for the list of available units.</p>
<p>ACCEPT    UNITS</p>	<p>The Accept Units prompt will only appear if one or more of the units have been changed.</p> <p><b>IMPORTANT:</b> Accepting the change of units will initiate a master reset. All calibration parameters will revert to their default value (i.e. those values included in the downloaded instrument software). All totals and any logged information will be cleared.</p> <p>Press ▲ or ▼ to select YES, then press the <b>SET</b> key. The instrument makes three beeps to confirm the reset command.</p> <p>The message -RESET- PLEASE WAIT will be displayed as the instrument exits calibration mode and completes a full re-boot sequence.</p>

## Parameters

 ↓	 → UNITS <b>PARAMS</b> INPUTS OUTPUTS ALARMS COMMS TM/LOG SETUP TEST END
CTRL MODE	<p>Select the required loop control mode.</p> <ul style="list-style-type: none"> <li>• <b>LOCAL</b> - Manual control operating mode</li> <li>• <b>LOOP</b> - PI loop control operating mode</li> <li>• <b>TUNE</b> - PI loop control tuning mode</li> <li>• <b>RATIO</b> - ratio of two flows without blending</li> <li>• <b>BLEND-1</b> - blending point after main flowmeter</li> <li>• <b>BLEND-2</b> - blending point before main flowmeter</li> </ul> <p>Press  or  to select the required control mode.</p> <p>Refer to the section Control Modes for descriptions of each mode.</p>
<p><b>Note:</b> The flow control items actually shown in the PARAMS menu are dependent on the CONTROL MODE chosen above. Items that are not relevant for that mode will not appear. Use the Calibration Menu Tree as a guide to the relevant items.</p>	
P-FLOW RANGE	<p>The process or loop flow range is the maximum flowrate that the system will achieve on the process flow line. This value is used by the loop control algorithm and is entered in the same units as the main menu Process Flowrate variable. It can be determined by setting the process control setpoint to 100% whilst in LOCAL mode and observing the flowrate.</p>
P-BAND %	<p>The proportional band of PI control algorithm.</p> <p>Enter the value in percentage. For means of determining this value see <a href="#">Tuning the Control Loop</a> on page 25.</p>
I-TIME SEC	<p>The loop integral time of PI control algorithm. This parameter must be set to a non-zero value to enable the integral term in the control algorithm.</p> <p>Enter the value in seconds. For means of determining this value see <a href="#">Tuning the Control Loop</a> on page 25.</p>
T-TIME SEC	<p>The loop ratio trim time. The integral time of cascade trim control can be used when it is critical for the totals to maintain the correct ratio. If enabled (non-zero), the trim control will modify the process flow to achieve the correct ratio between the totals.</p>
I-BAND %	<p>The loop error deadband can be programmed to prevent the output continuously changing and thereby reducing wear on valves and actuators. Enter the value as a percentage.</p> <p>While the main menu Deviation (error) is within the deadband, the process control signal will remain steady (i.e. the error is treated as zero in the algorithm).</p>

<span style="border: 1px solid black; border-radius: 50%; padding: 2px;">SET</span> ↓		<span style="border: 1px solid black; border-radius: 50%; padding: 2px;">▶</span> → UNITS <b>PARAMS</b> INPUTS OUTPUTS ALARMS COMMS TM/LOG SETUP TEST END
R-TIME	SEC	<p>The ramp time limits the rate of change of the loop output signal and assists in bumpless loop operation when changing operation mode or loop parameters. It represents the minimum time required for the output signal to traverse between saturation points (i.e. from 0 to 100% or vice versa).</p>
HOLD	CTRL	<p>The hold control output feature leaves the output signal at its last value at the end of a batch (flow should be stopped by the on-off valve).</p> <p>This allows the control actuator to start a new batch without ramping up from a fully closed position.</p> <p>Press <span style="border: 1px solid black; padding: 0 5px;">▲</span> or <span style="border: 1px solid black; padding: 0 5px;">▼</span> to select ENABLE or DISABLE.</p>
HOLD	SEC	<p>The hold control output time determines when the loop control takes over after a batch starts or resumes. This can provide time for the on-off valve to open and flow to reach a stable flowrate before the systems resumes loop control.</p>
BATCH	MODE	<p>Select the required batch operation mode.</p> <ul style="list-style-type: none"> <li>• <b>PRESET</b> - Preset delivery.</li> <li>• <b>ON-OFF</b> - Manual delivery.</li> <li>• <b>RELEASE</b> - Release flow (loop tuning, only available in calibration mode).</li> </ul> <p>Press <span style="border: 1px solid black; padding: 0 5px;">▲</span> or <span style="border: 1px solid black; padding: 0 5px;">▼</span> to select either: PRESET, ON-OFF or RELEASE.</p> <p>Refer to the section Batch Modes for descriptions of each mode.</p>
<p><b>Note:</b> The batch control items actually shown in the PARAMS menu are dependent on the BATCH MODE chosen above. Items that are not relevant for that mode will not appear. Use the Calibration Menu Tree as a guide to the relevant items.</p>		
PERMIS	INPUT	<p>The permissive input feature ensures that a batch will not be allowed until a permissive contact is closed. A prompt to connect permissive is displayed. The requirement for the permissive can be enabled or disabled.</p> <p>For more details, refer to <b>Logic Input Control</b> on page 30.</p> <p>Press <span style="border: 1px solid black; padding: 0 5px;">▲</span> or <span style="border: 1px solid black; padding: 0 5px;">▼</span> to select ENABLE or DISABLE.</p>
BATCH	LIMIT	<p>The batch limit determines the maximum batch preset value that can be entered. If a value of zero is entered for this parameter then no limit is applied.</p> <p>Enter the value in the engineering units of the batch preset.</p>





 ↓	 → UNITS <b>PARAMS</b> INPUTS OUTPUTS ALARMS COMMS TM/LOG SETUP TEST END
P--STOP VALUE	<p>The prestop value determines when relay 2 deactivates as the batch approaches the preset quantity.</p> <p>Enter the value in the engineering units of the batch preset.</p>
ACCEPT TOTAL	<p>The batch acceptable total is the minimum total for the system leakage to be logged (a value of zero disables logging of leakages). It also allows small totals due to “meter skips” and vibration to be discarded without being considered as a valid delivery.</p> <p>Enter the value in the engineering units of the batch preset.</p>
S--STRT SEC	<p>The batch slow start time determines when relay 2 activates after the start or resumption of a batch.</p> <p>Enter the value in seconds.</p>
A--STRT SEC	<p>The batch automatic restart time determines the time that will elapse between the end of one batch and the start of the next. A value of zero disables the auto restart feature.</p> <p>Enter the value in seconds.</p>
T--OUT SEC	<p>The batch flow timeout determines the length of no flow time that the instrument will wait during a batch before raising a no flow error. It also determines when an overflow error is raised if flow does not cease within the timeout period after the controller attempts to stop the flow. A value of zero disables these flow timeout features.</p> <p>Enter the value in seconds.</p>
AUTO RESET	<p><i>This parameter is available for viewing and editing only when the batch automatic restart time is set to zero.</i></p> <p>The automatic reset feature allows the previous batch total to be reset automatically when a new batch is started with the RUN key.</p> <p>Press  or  to select ENABLE or DISABLE.</p>

SET ↓	▶ → UNITS <b>PARAMS</b> INPUTS OUTPUTS ALARMS COMMS TM/LOG SETUP TEST END
AUTO COMP	<p>The batch automatic overrun compensation allows the instrument to automatically compensate for any consistent overrun at the end of the batch. Overrun is typically due to the slowness of a valve to close or a pump to stop on receiving a signal from the batch controller and results in the delivered quantity being greater than the entered preset.</p> <p>In calculating the amount to be compensated for the instrument uses the average overrun from the last three batches. An overrun of more than 20% is considered invalid and will not be included in the calculations.</p> <p>Press ▲ or ▼ to select ENABLE or DISABLE.</p>
No -SET BATCH	<p>To provide faster access to commonly used preset values a number of batch presets can be preprogrammed into the instrument. This parameter allows the number of batch presets to be entered.</p> <p>Press ▲ or ▼ to select a number between 1 and 10.</p>
SET-01 BATCH to SET-n	<p>Enter the commonly used preset values for quick access via the front panel.</p> <p>Enter the value in the engineering units of the batch preset.</p>
DIRECT ACCESS	<p>If the direct access is enabled then the operator is able to enter edit mode for the batch preset and flow parameters directly from the main menu by holding the SET key while viewing the preset. If disabled, the changes can only be made from within the calibration set mode (or via serial communications, see below). Select the direct access mode as required.</p> <p>Press ▲ or ▼ to select ENABLE or DISABLE.</p>
<p><b>Modbus Accessible Parameters</b></p> <p>The following PARAMS menu items are also accessible via Modbus communications. For a complete Modbus parameter listing, refer to <a href="#">Instrument Configuration Parameters</a> on page 75.</p>	
P-CTRL SP	<p>Preset process control signal setpoint. This setpoint is only available for LOCAL control mode.</p> <p>Enter the value in the engineering units of the assigned variable.</p>
<p>If LOCAL control mode the live P-FLOW value is now shown to give immediate feedback without leaving calibration set mode.</p>	
P-FLOW SP	<p>Preset Loop/Process flowrate setpoint. This setpoint is only available for LOOP control and TUNE modes. The value of the setpoint must not be greater than the process flow range (P-FLOW RANGE).</p>

SET ↓	▶ → UNITS <b>PARAMS</b> INPUTS OUTPUTS ALARMS COMMS TM/LOG SETUP TEST END
If LOOP control or TUNE mode the live P-FLOW and DEVIATION values are now shown to give immediate feedback without leaving calibration set mode.	
PRESET BATCH	<p>Enter the batch preset quantity. This setpoint is only available for PRESET batch mode.</p> <p>Enter the value in the engineering units of the assigned variable.</p>

## Inputs

SET ↓	▶ → UNITS PARAMS <b>INPUTS</b> OUTPUTS ALARMS COMMS TM/LOG SETUP TEST END
<b>Analog Input 3 &amp; 4</b>	
<b>INPUT</b> M-FLOW AINP3 P-FLOW AINP4	For this application Analog Input Channels 3 is assigned to main line flowrate input. Analog Input Channel 4 is assigned to the process line flowrate input.
TYPE AINP3 AINP4	Select the type of analog input source.  Press <input type="button" value="▲"/> or <input type="button" value="▼"/> to select 0-5V, 1-5V or 4-20mA.
PT-MIN AINP3 PT-MAX AINP4	Enter the value of the measured parameter (in the defined engineering units) that corresponds to the minimum input signal level. The minimum point is commonly set at a base flowrate of 0.0.  Enter the value of the measured parameter (in the defined engineering units) that corresponds to the maximum input signal level. The maximum point is the same as the base value (set at the minimum point) plus the span value.  For example, if the source signal is 4mA at a minimum volumetric flowrate of 2m <sup>3</sup> /M, enter 2 as the minimum point. If the source signal is 20mA at a maximum volumetric flowrate of 250m <sup>3</sup> /M, enter 250 as the maximum point.
CUTOFF AINP3 AINP4	The Cut-off is the lowest value that the instrument reads from the input sensor. The cut-off setting is the percentage of the span of the input values.  All inputs at or below the cut-off value are considered negligible to the instrument and are ignored. In this case, the instrument uses the minimum value (set at PT-MIN).

 ↓	 → UNITS PARAMS <b>INPUTS</b> OUTPUTS ALARMS COMMS TM/LOG SETUP TEST END		
FILTER    RINP3 RINP4	<p>Input fluctuations caused by pulsating flow tend to create distortion in the input readings of the rate. The instrument has a digital filter that averages out these fluctuations.</p> <p>As a guide to the degree of filtering to use, the following table shows the response time (in seconds) to reach 90% and 99% of a step change in input.</p> <p>The value A is the filter constant that the user can set.</p>		
	<b>Filter setting A</b>	Seconds to reach 90% of full swing	Seconds to reach 99% of full swing
	0	0	0
	2	2	4
	4	4	8
	6	5	10
	10	8	15
	15	12	23
	20	14	27
	25	18	34
	35	25	48
	45	32	62
	60	42	82
	75	52	102
	90	62	122
	99	68	134
	<p>The input filter range is from 0 to 99. A setting of 0 (zero) means that there is no filtering.</p>		
CORR      RINP3 RINP4	<p>Analog input non-linearity can be corrected as follows:</p> <ul style="list-style-type: none"> <li>• LINEAR</li> <li>• NON-LINEAR to use the following linearity correction parameters</li> </ul> <p>Use  or  to select LINEAR or NON-LINEAR.</p>		



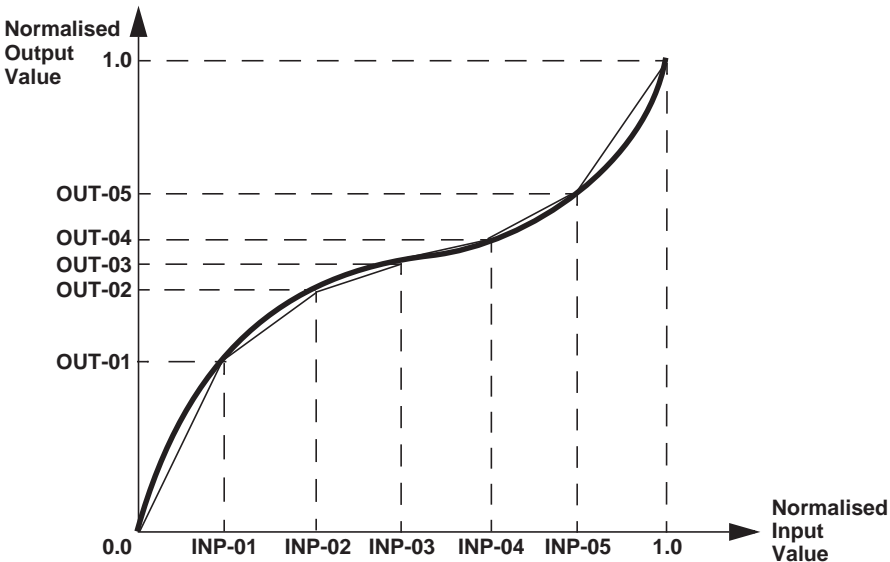





SET ↓	▶ → UNITS PARAMS <b>INPUTS</b> OUTPUTS ALARMS COMMS TM/LOG SETUP TEST END
NO-PTS A INP3 A INP4	<p><i>This parameter is available for viewing and editing only when the correction type is set to Non-linear.</i></p> <p>Enter the number of non-linearity correction points.</p> <p>Press ▲ or ▼ to select a number between 1 and 20 for the number of correction points.</p>
INP--01 to INP--n A INP3 A INP4	<p><i>This parameter is available for viewing and editing only when the correction type is set to Non-linear.</i></p> <p>Enter the normalised input value for the correction point.</p> <p>The instrument uses linear interpolation between the correction points. An input and an output value are entered for each correction point. The values are normalised between the minimum point (0.0) and the maximum point (1.0). Only the points between 0 and 1 are required to be entered and should be entered in ascending order.</p> <p>The following diagram shows a 5 point linearised representation of the input for a hypothetical flowmeter. The heavy black line represents the actual input from the flowmeter. The light black line is the approximation that the instrument uses.</p>  <p>You can press the <b>DISPLAY</b> key to skip the non-linear points and go to the next item.</p>
OUT--01 to OUT--n A INP3	<p><i>This parameter is available for viewing and editing only when the correction type is set to Non-linear.</i></p> <p>Enter the normalised output value for the correction point.</p>

SET ↓	▶ → UNITS PARAMS <b>INPUTS</b> OUTPUTS ALARMS COMMS TM/LOG SETUP TEST END
STACK AINP3	<p>Select YES to stack AINP3 as the low range input with AINP4 as the high range input.</p> <p>Select NO to use AINP3 as the only flow input.</p>
SW-LO AINP3 SW-HI	<p><i>These parameters are available for viewing and editing only when the Stack option is set to Yes.</i></p> <p>Stacked DP switching is based on the low-range input (AINP3). When the input is less than the SW-LO value, the instrument switches to the low-range input (AINP3). When the input is greater than the SW-HI value, the instrument switches to the high-range input (AINP4).</p> <p>The switch settings are percentages of the span of the unadjusted input to AINP3. For example, with a 4-20mA input, a setting of 90% is 18.4mA and 95% is 19.2mA.</p> $\frac{(20 - 4) \times 90}{100} + 4 = 18.4 \qquad \frac{(20 - 4) \times 95}{100} + 4 = 19.2$ <p>Enter SW-LO and SW-HI values as 0 to 99%. SW-HI should be set sufficiently higher than SW-LO to avoid rapid toggling between the two inputs.</p>

## Outputs

SET ↓	▶ → UNITS PARAMS INPUTS <b>OUTPUTS</b> ALARMS COMMS TM/LOG SETUP TEST END
<p><b>Note:</b> In the factory default version of this application output channel 1 (OUT1) is dedicated as the 4-20mA Process Control signal. Output channel 2 can be freely configured.</p>	
FLINE OUTn	<p>The output can function as either a pulse output for retransmission of totals, a no flow error signal, a pump control output or an end of batch signal. (Note: there is no End of batch signal if Batch mode is ON-OFF).</p> <p>Press ▲ or ▼ to select RETRANS, OP-ERR, OP-CTRL or OP-END</p>

 ↓	 → UNITS PARAMS INPUTS <b>OUTPUTS</b> ALARMS COMMS TM/LOG SETUP TEST END
PULSE or 4-20  OUT <sub>n</sub>	<p>You can assign any of the “main menu” variables to an output. The nature of the output depends on the assigned variable. Totals are output as pulses and rates are output as 4-20mA passive signals.</p> <p>Press  or  to select the variable that is required as an output. The top of the display shows the type of output signal that is assigned to the variable.</p> <p style="text-align: center;"><b>CAUTION</b></p> <p style="text-align: center;">Due to the dual-purpose nature of the outputs, take care not to set the output as an open collector pulse type signal when connected to a 4-20mA loop circuit.</p>
WIDTH  OUT <sub>n</sub>	<p><i>The Output Pulse Width is available for viewing and editing only when the assigned variable is a total (pulse output) type.</i></p> <p>Pulse output is usually used to drive remote counters. Set the pulse width (in milliseconds) as required by the remote counter.</p> <p>Press  or  to set to: 10, 20, 50, 100, 200 or 500ms.</p>
PULSE  OUT <sub>n</sub>	<p><i>The Output Pulse Factor is available for viewing and editing only when the assigned variable is a total (pulse output) type.</i></p> <p>The Output Pulse Factor is the scaling factor for the retransmission of the measured total quantity.</p> <p>For example, if “volume” is chosen as an output variable and engineering unit is cubic metres, then a pulse factor of 1.000 generates one pulse for 1 m<sup>3</sup>. Similarly, a pulse factor of 3.000 generates one pulse for 3 m<sup>3</sup>.</p> <p>For more information, see <b>Output Pulse Factor</b> on page 50.</p> <p>The output pulse factor cannot be 0 (zero).</p>

SET ↓	▶ → UNITS PARAMS INPUTS <b>OUTPUTS</b> ALARMS COMMS TM/LOG SETUP TEST END
PT-MIN    OUTn PT-MAX    OUTn	<p><i>The Output Minimum Point and Maximum Point are available for viewing and editing only when the assigned variable is a rate (4-20mA output) type.</i></p> <p>The output minimum value corresponds to the 4mA point and the output maximum value corresponds to the 20mA point.</p> <p>Setting the output range differently from the input range enables the instrument to amplify the input signal. You can drive a chart recorder that “zooms in” on a specified range of values instead of displaying the full operating range of the transducer.</p> <p>For example, if “volume flow” is chosen as an output variable and engineering unit is cubic metres per minute, then setting the minimum point to 30 and the maximum point to 100 would reflect the volumetric flow rate range of 30 to 100m<sup>3</sup>/min. At rates above the maximum and below the minimum points, the output remains at 20mA and 4mA respectively.</p>

### Output Pulse Factor

Increasing the output pulse width reduces the maximum frequency at which a total variable can be retransmitted. Pulses will be missed if the output cannot “keep up” with the rate of total counts. You can use the output pulse factor to ensure that this maximum is not reached.

The maximum pulse output frequency is determined by:

$$\frac{1000}{(2 \times \text{pulse width in ms})} \text{ Hz}$$

The minimum pulse factor required is determined by:

$$\frac{\text{max rate of total}}{\text{max pulse output frequency}}$$

For example: To calculate the required pulse factor to avoid losing counts in retransmission if a total counts at a maximum rate of 75 units/sec (Hz) and the required pulse width of a remote counter is at least 50ms:

The maximum pulse output frequency is:  $\frac{1000}{2 \times 50} = 10 \text{ Hz}$

The minimum pulse factor for that frequency is:  $\frac{75}{10} = 7.5$

## Alarms

The alarm relay(s), in the advanced option, can be assigned to rate variables such as volume flowrate, or set as an equipment failure alarm.

The alarm switches “on” whenever an alarm condition exists. The alarm switches “off” when the alarm condition no longer exists. However, you may need to configure external alarm devices that require acknowledgement for cancelling an alarm.

### Equipment Failure Alarm

Any alarm relay can be assigned as an equipment failure alarm. This alarm setting can have normally closed (open) contacts that open (close) when the instrument displays any error message as listed in [Error Messages](#) on page 59.

<input type="button" value="SET"/> ↓	<input type="button" value="▶"/> → UNITS PARAMS INPUTS OUTPUTS <b>ALARMS</b> COMMS TM/LOG SETUP TEST END
RELAY ALRM <sub>n</sub>	<p>Select a rate variable to assign to the alarm relay.</p> <p><b>Note:</b> If the alarm type is set to “equipment alarm”, this relay assignment setting is ignored.</p> <p>Press <input type="button" value="▲"/> or <input type="button" value="▼"/> to select the variable that is required as an alarm.</p>
TYPE ALRM <sub>n</sub>	<p>The options available for alarm types are as follows:</p> <ul style="list-style-type: none"> <li>• HI-NO — High Alarm, Normally Open contacts</li> <li>• HI-NC — High Alarm, Normally Closed contacts</li> <li>• LO-NO — Low Alarm, Normally Open contacts</li> <li>• LO-NC — Low Alarm, Normally Closed contacts</li> <li>• BD-NO — Band Alarm, Normally Open contacts</li> <li>• BD-NC — Band Alarm, Normally Closed contacts</li> <li>• AL-NO — Equipment Alarm, Normally Open contacts</li> <li>• AL-NC — Equipment Alarm, Normally Closed contacts</li> </ul> <p>Press <input type="button" value="▲"/> or <input type="button" value="▼"/> to select the type of alarm required.</p>
POINT ALRM <sub>n</sub>	<p><i>The Alarm Setpoint is available for viewing and editing for any alarm type except ‘equipment alarms’.</i></p> <p>The Alarm Setpoint is the value (in engineering units of assigned variable) at which the alarm condition occurs and therefore the alarm is on.</p> <p>Each alarm is completely independent, e.g. a High alarm does NOT need to have a higher setpoint than the a Low alarm.</p>

<div style="display: inline-block; border: 1px solid black; padding: 2px;">SET</div> ↓		<div style="display: inline-block; border: 1px solid black; padding: 2px;">▶</div> → UNITS PARAMS INPUTS OUTPUTS <b>ALARMS</b> COMMS TM/LOG SETUP TEST END
HYST	ALRM $n$	<p><i>The Alarm Hysteresis is available for viewing and editing for any alarm type except 'equipment alarms'.</i></p> <p>Alarm hysteresis loops occur when the alarm toggles continuously on and off when the process variable is close to the setpoint.</p> <p>For a high alarm, the alarm activates when the value of the variable rises above the alarm setpoint and deactivates when the value falls below the alarm setpoint minus the amount of the hysteresis setting (if any).</p> <p>For a low alarm, the alarm activates when the value of the variable falls below the alarm setpoint and deactivates when the value rises above the alarm setpoint plus the amount of the hysteresis setting (if any).</p> <p>For a band alarm, the alarm activates whenever the value of the variable is outside the setpoint plus or minus the amount of the hysteresis.</p> <p>For example, with a high alarm setpoint of 200, and a hysteresis setting of zero, a value oscillating between 197 and 202 will cause the alarm to toggle on at 200 and toggle off below 200. However, if the hysteresis is set to 5, the value of the variable must fall below 195 to cancel the alarm. The alarm will reactivate only when the value again rises above 200.</p>
DELAY	ALRM $n$	<p>The Alarm Delay is programmed in seconds and can be used to eliminate undesired alarm activation during start-up or shutdown operation.</p>

## Communications

The instrument has three communication ports:

- **RS-232 Port** - A 9-pin female connector on the rear panel of the instrument.
- **RS-485 Port** (optional) - Terminals on the rear panel.
- **Infra-red Port** - Discontinued - Although program settings may be visible in calibration, the required hardware is no longer available. The Infra-red protocol assignment (PROT $\square$  INFR $\square$ ) should be set to NONE and the remaining INFR $\square$  settings can be ignored.

<input type="button" value="SET"/> ↓	<input type="button" value="▶"/> → UNITS PARAMS INPUTS OUPUTS ALARMS <b>COMMS</b> TM/LOG SETUP TEST END
<b>PROTOD</b> RS232 RS485 INFRA	<p>The Communications Protocols can be assigned to the communication ports as follows (a protocol cannot be assigned to more than one port at a time):</p> <ul style="list-style-type: none"> <li>• <b>ASCII</b>    - Simple ASCII        available for all ports</li> <li>• <b>RTU</b>        - Modbus RTU        available for all ports</li> <li>• <b>PRN</b>        - Printer Protocol    available for RS232 and RS485</li> <li>• <b>NONE</b>      - If a port is not being used, set the protocol to NONE.</li> </ul> <p>Printer Protocol (PRN) is only available if the option with Real Time Clock is installed.</p> <p>For the selected port, press <input type="button" value="▲"/> or <input type="button" value="▼"/> to select the desired protocol.</p>
<b>BAUD</b> RS232 RS485 INFRA	<p>The Baud setting is the speed of the communication port in data bits per second.</p> <p>The baud rate of the instrument must match the baud rate of the communication device that the instrument is connected to.</p> <p>Use <input type="button" value="▲"/> or <input type="button" value="▼"/> to select 2400, 4800, 9600 or 19200 baud.</p>
<b>PARITY</b> RS232 RS485 INFRA	<p>The Parity bit helps to detect data corruption that might occur during transmission.</p> <p>The parity bit setting of the instrument must match the parity bit setting of the communication device that the instrument is connected to.</p> <p>Press <input type="button" value="▲"/> or <input type="button" value="▼"/> to select EVEN, ODD, or NONE.</p>
<b>S-BITS</b> RS232 RS485 INFRA	<p>The Stop bit indicates the end of a transmission. Stop bits can be 1 or 2 bit periods in length. The stop bit setting of the instrument must match the stop bit setting of the communication device that the instrument is connected to.</p> <p>Press <input type="button" value="▲"/> or <input type="button" value="▼"/> to select 1 or 2 stop bits.</p>
<b>RTU</b> DATA	<p>The Modbus RTU data format for the 2-register (4-byte) values can be set as either floating point or long integer values.</p> <p>Use <input type="button" value="▲"/> or <input type="button" value="▼"/> to select FLOAT or INTEGER.</p>

<input type="button" value="SET"/> ↓		<input type="button" value="▶"/> → UNITS PARAMS INPUTS OUPUTS ALARMS <b>COMMS</b> TM/LOG SETUP TEST END
RTU	ADDR	<p>The Modbus RTU protocol address must be in the range of 1 to 247. When multiple instruments (slaves) are connected to one communication device (master), each assigned address must be unique.</p> <p><b>Note:</b> The master device uses the RTU address 0 (zero) for broadcasting to all connected slave units.</p>
ASCII	ADDR	<p>The ASCII protocol address identifies each communicating device.</p> <p>The address must be in the range of 1 to 255. When multiple instruments (slaves) are connected to one computer (master), each assigned address must be unique.</p>
FLASH	PORT	<p>The Flash Driver Port assignment defines the communication port for downloading software into the instrument.</p> <p>The default setting of this assignment is the RS-232 port.</p> <p>Press <input type="button" value="▲"/> or <input type="button" value="▼"/> to select RS-232, RS-485, or INFRA.</p>

## Time Settings and Data Logging

### Instrument Clock

**Note:** The real-time clock is part of the advanced option package.

The instrument has a real-time clock for recording logged events. The clock displays the time and the date. The date format can be set to European format (day/month/year) or American format (month/day/year). The time clock uses the 24-hour format.

The clock will continue to operate for up to 5 years (typically) on the internal battery if there is no power connected to the instrument. Therefore, after an interruption to the power supply, the instrument recommences normal operation although there will be no data recorded during the period without a power supply.

**Note:** If there is an interruption to the power supply and the battery has failed, the instrument displays an error message when the power supply is restored. In this case, you should set the current time and date so that the instrument continues to log data at the correct times.

### Data Logging

The instrument will log a total of 1000 deliveries (batches) if the real-time clock option is installed. The logs are taken at the end of each batch or upon reset if a batch has been aborted before the preset total has been reached.



<input type="button" value="SET"/> ↓	<input type="button" value="▶"/> → UNITS PARAMS INPUTS OUPUTS ALARMS COMMS <b>TM/LOG</b> SETUP TEST END
DATE      FORM	<p>Clock Date Format</p> <p>The European date format is: dd/mm/yyyy or (Day-Month).</p> <p>The American date format is: mm/dd/yyyy or (Month-Day).</p> <p>Press <input type="button" value="▲"/> or <input type="button" value="▼"/> to select DAY-M or M-DAY</p>
CLOCK      YEAR	The Clock Year defines the current year for the real-time clock.
CLOCK      M-DAY	The Clock M-DAY setting defines the current month and date for the real-time clock. This parameter is programmed in Month-Day format for both European and American date formats.
CLOCK      H-MIN	The Clock H-MIN setting is the current time in hours and minutes for the real-time clock.
RESET      LOGS	<p>Reset the logged data. You may need to reset (clear) the logged data if you change the time/log settings.</p> <p>Press <input type="button" value="▲"/> or <input type="button" value="▼"/> to select YES, then press the <input type="button" value="SET"/> key. The instrument makes three beeps to confirm the reset command.</p>
REPORT      LOGS	<p>The Printer Protocol Report Logs defines the number of latest logs to be included into a printable report.</p> <p>Enter the number of logs between 0 and 99.</p>
REPORT      TYPE	<p>The Printer Protocol Report Type determines the nature of the printout from the REPORT PRINT - HOLD.SET prompt in the main menu. The following report types available in this instrument are:</p> <ul style="list-style-type: none"> <li>• REP-10      Preset number of latest logs</li> </ul> <p>Press <input type="button" value="▲"/> or <input type="button" value="▼"/> to select Report Type.</p>

SET ↓	▶ → UNITS PARAMS INPUTS OUPUTS ALARMS COMMS <b>TM/LOG</b> SETUP TEST END
PRN TYPE	<p>The Printer Protocol Printer Type allows the nature of the printer being used to be specified. The following printer types available in this instrument are:</p> <ul style="list-style-type: none"> <li>• PRN-01      Generic computer printer</li> <li>• PRN-02      Generic roll printer (prints first line first)</li> <li>• PRN-03      Slip printer TM295</li> <li>• PRN-04      Label (roll) printer - Citizen CMP30L</li> </ul> <p>Press ▲ or ▼ to select Printer Type.</p>
AUTO PRINT	<p>The Auto Print function, if enabled, allows a delivery docket print out to occur automatically at the End of Batch. If disabled, a printout must be initiated via the HOLD.SET - TO PRINT prompt in the main menu.</p> <p>Press ▲ or ▼ to select ENABLE or DISABLE.</p>

## General Setup Parameters

SET ↓	▶ → UNITS PARAMS INPUTS OUPUTS ALARMS COMMS TM/LOG <b>SETUP</b> TEST END
DEFAULT VAR	<p>Select the main menu variable to display on power up or when the display timeout period has elapsed if it is enabled.</p> <p>Press ▲ or ▼ to select the default variable display.</p>
SUPPLY VOLT	<p>The instrument provides a power-limited supply for external transducers.</p> <p>Press ▲ or ▼ to set the transducer supply voltage between 8 and 24 volts DC as required.</p>

<div style="border: 1px solid black; padding: 2px; display: inline-block;">SET</div> ↓	<div style="border: 1px solid black; padding: 2px; display: inline-block;">▶</div> → UNITS PARAMS INPUTS OUPUTS ALARMS COMMS TM/LOG <b>SETUP</b> TEST END
T-OUT MODE	<p>If the Display Timeout mode is enabled, and there is no user activity for the defined timeout period, the display panel returns to the default display.</p> <p>This function is useful for the following reasons:</p> <ul style="list-style-type: none"> <li>• to return the display to a preferred variable after the user has finished reading other information,</li> <li>• to cancel the calibration mode and return to the default display if the user does not exit from the calibration mode for any reason.</li> </ul> <p>Press <div style="border: 1px solid black; padding: 2px; display: inline-block;">▲</div> or <div style="border: 1px solid black; padding: 2px; display: inline-block;">▼</div> to select the display timeout function as follows:</p> <ul style="list-style-type: none"> <li>• <b>DISABLE</b> - Timeout is completely disabled.</li> <li>• <b>EN DISP</b> - Timeout is enabled during Normal mode and Calibration View mode.</li> <li>• <b>EN EDIT</b> - Timeout is enabled during Calibration Set mode.</li> <li>• <b>EN ALL</b> - Timeout is enabled for all modes.</li> </ul>
T-OUT SEC	<p>The Display Timeout period defines the delay for the Display Timeout mode if it is enabled.</p> <p>The display timeout period can be from 10 to 99 seconds.</p>
RESET ACCUM	<p>The Reset Accumulated Totals function clears all of the accumulated totals and the non-accumulated totals.</p> <p>Press <div style="border: 1px solid black; padding: 2px; display: inline-block;">▲</div> or <div style="border: 1px solid black; padding: 2px; display: inline-block;">▼</div> to select YES, then press the <div style="border: 1px solid black; padding: 2px; display: inline-block;">SET</div> key. The instrument makes three beeps to confirm the reset command.</p>
DISPL TAGS	<p>The Display Tags option determines whether the instrument displays the default display tags or the user-defined tags. The display tag setting also defines whether the instrument displays the default error and warning messages, or the user-defined messages.</p> <p><b>Note:</b> The user-defined tags can be entered into the instrument only by the manufacturer or the distributor.</p> <p>Press <div style="border: 1px solid black; padding: 2px; display: inline-block;">▲</div> or <div style="border: 1px solid black; padding: 2px; display: inline-block;">▼</div> to select the Display Tags option as follows:</p> <ul style="list-style-type: none"> <li>• <b>DEFAULT</b> - the instrument displays the default (English) tags</li> <li>• <b>USER</b> - the instrument displays the user-defined tags.</li> </ul>

SET ↓	▶ → UNITS PARAMS INPUTS OUPUTS ALARMS COMMS TM/LOG <b>SETUP</b> TEST END
BACK-L T-OUT	<p>If the backlight timeout is enabled, and there is no user activity (any keys pressed) for a period of 10 seconds, the display backlight switches off to save power. The backlight switches on when a key is pressed. Select the backlight timeout mode as required.</p> <p>Press ▲ or ▼ to select ENABLE or DISABLE.</p>
RATES DP	This parameter sets the maximum number of decimal places for displaying or printing main menu rates.
TOTALS DP	This parameter sets the maximum number of decimal places for displaying or printing main menu totals.

## Test Menu

The Test menu enables you to view the inputs and outputs to and from the instrument.

In Calibration Set mode, (by entering the system password) you can control the outputs and the alarms as described in the table below.

SET ↓	▶ → UNITS PARAMS INPUTS OUPUTS ALARMS COMMS TM/LOG SETUP <b>TEST</b> END
AINP <sub>n</sub> units	The units are displayed according to the calibration setup for the analog input. If unused or set to Default the input is 4-20mA and displayed in mA.
LINP <sub>n</sub> STATE	You can view the state of the logic inputs. If the input is an open contact or inactive it will display <b>HI</b> . If the input is a closed contact or active it will display <b>LO</b> .
OUT <sub>n</sub> STATE	<p>You can control the state of the outputs. Press the ▲ or ▼ keys to set the output state as follows:</p> <ul style="list-style-type: none"> <li>• <b>PROCESS</b> - the output depends on the current values of the inputs and the calculations that the instrument performs.</li> </ul> <p>For a pulse output, such as a total, the output produces a pulse train as follows:</p> <ul style="list-style-type: none"> <li>• <b>ON</b> - a pulse train with a pulse width as set for the particular output in the Outputs menu.</li> <li>• <b>OFF</b> - no output.</li> </ul> <p>For a 4-20mA output, such as a rate, the output is as follows:</p> <ul style="list-style-type: none"> <li>• <b>HI</b> - the output is set to 20mA.</li> <li>• <b>LO</b> - the output is set to 4mA.</li> </ul>

SET ↓	▶ → UNITS PARAMS INPUTS OUPUTS ALARMS COMMS TM/LOG SETUP <b>TEST</b> END
ALRMn STATE or REL -n	<p>You can control the state of the relays (alarms). Press the ▲ or ▼ keys to set the selected relay as follows:</p> <ul style="list-style-type: none"> <li>• <b>PROCESS</b> - the relay operates according to the current values of the inputs and the relay settings as programmed.</li> <li>• <b>OPEN</b> - the relay output contacts are set to “open”.</li> <li>• <b>CLOSED</b> - the relay output contacts are set to “closed”.</li> </ul>
SUPPLY ✓	<p>You can display the actual DC output supply voltage, which may help with troubleshooting.</p> <p>If the actual supply voltage is lower than the preset value (refer to <b>General Setup Parameters</b> on page 56) it may indicate that the output is overloaded.</p>

## System Messages

The instrument displays messages for defined events and fault conditions.

The manufacturer or distributor can enter user-defined text for the messages. This user-defined text is displayed, instead of the default (English) messages, when the Display Tags option in the Setup menu is set to USER.

## Error Messages

The system displays error messages, and records the associated exception status code, in the order of highest to lowest priority as listed in the following table:

Error Messages	Status Code	Description - (Highest Priority at top of table).
CPU Card Failure	20	There are failed components on the CPU card and technical support is required.
Power Supply is Low	21	The input and/or output power supply voltage is too low, ensure that: (a) input power supply voltage is within the specified range (b) output power supply is not overloaded.

<b>Error Messages</b>	<b>Status Code</b>	<b>Description - (Highest Priority at top of table).</b>
New/Failed Battery - Set Time	22	The real-time clock has lost the correct time because the battery has failed, or there is a new battery. Set the current time and date (in the TM/LOG menu) to clear the error message and to continue data logging at the correct times.  <b>Note:</b> The instrument can continue operating with a failed battery, but the correct time will be lost if there are interruptions to the power supply.
No Flow Detected	12	The no flow condition is detected when the flow timeout expires during a delivery. There must not be a period of no flow greater than the timeout value during the delivery.
Unexpected/Over Flow	13	The unexpected/over flow condition is detected when the flow continues longer than the timeout period after the controller has attempted to stop (or pause) the flow.
Leakage Detected	14	The leakage condition is detected when an amount greater than the acceptable total is received without flow being initiated by the batch controller.

## Warning Messages

The system displays warning messages as described in the following table:

<b>Warning Messages</b>	<b>Description</b>
Value Has Been Set to Default	You have entered an invalid value for a parameter. Therefore, the instrument has set the default value.
Already Assigned to Other Port	You have tried to assign a particular protocol type to more than one serial communication port. The instrument has set the protocol to NONE.
Preset Over Limit - Max Set	You have exceeded the preset limit. The instrument will set the maximum allowed value.

## Prompt Messages

The system displays prompt messages as described in the following table:

<b>Prompt Messages</b>	<b>Description</b>
Connect Permissive	Connect permissive to proceed with batching.

# Chapter 6

## Communications

---

### Overview

This chapter describes the communications between the instrument and another communicating device such as a computer or a printer. You should have relevant information about the devices to which the instrument will be connected. Some connection examples are included in this manual, however, the operation and connection of other devices is outside the scope of this manual.

### Hardware Interconnection

The instrument has two communication ports:

- RS-232 port on the rear panel (DB9 female connector)
- RS-485 port on the rear panel (optional)

The appropriate interface and protocols are selected during calibration.

#### RS-232 Port

The RS-232 port provides communication between the instrument and one other device such as a host computer or a printer.

**Note:** A printer must have a serial port to be able to be directly connected to the flow computer. It is not possible to communicate directly with a printer via a parallel port.

Computers use either a DB9 or a DB25 connector, and the connections to each type are shown in Figure 17.

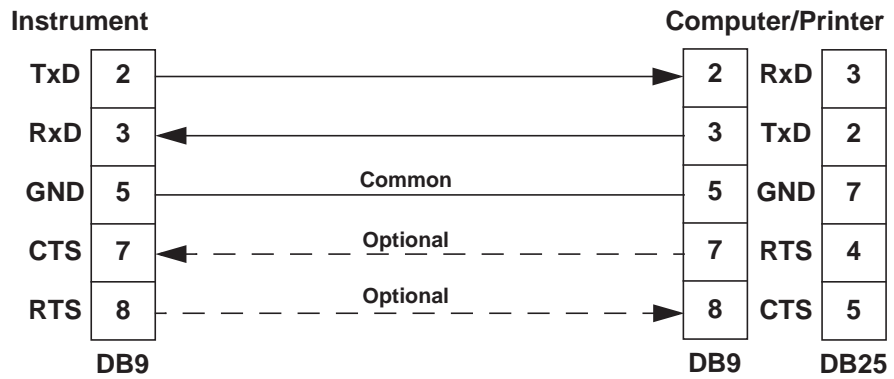

Figure 17 RS-232 Cable Connections to a Computer

**Note:** The instrument requires a cable with straight-through connections. Do not use a null modem cable for RS-232 connection to a computer.

### RS-485 Port

The RS-485 port enables communication with multiple devices. Each device has a unique address so that the “master” device can communicate with specific “slave” devices.

On RS-485 links, an external terminating resistor must be connected at the furthest end of the cable. When multiple instruments are connected, they should be “daisy chained” in a multidrop configuration as shown in Figure 18. Up to 32 units can be connected to the interface at a maximum distance of 1200 metres.

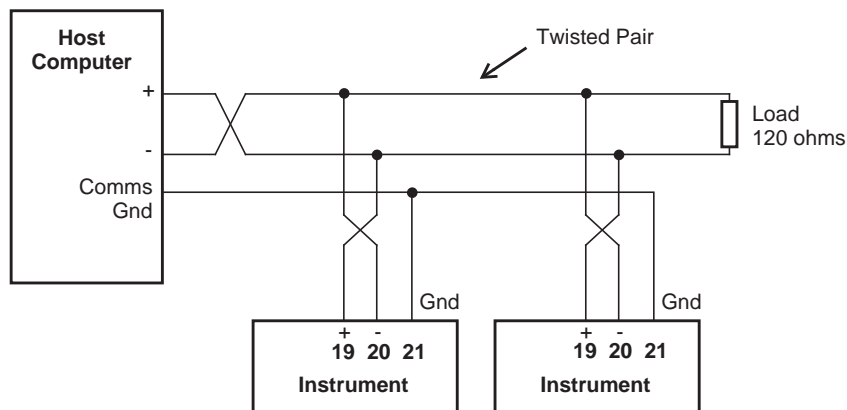

Figure 18 RS-485 Connections



## Protocols

The communications protocols can be assigned to the communication ports on the instrument as follows:

- **ASCII** - Simple ASCII available for all ports
- **RTU** - Modbus RTU available for all ports
- **PRN** - Printer Protocol available for RS232 and RS485
- **NONE** - If a port is not being used, set the protocol to NONE.

**Note:** The Printer Protocol is only available if the option with Real Time Clock is installed. Also a protocol cannot be assigned to more than one port at a time as described in **Communications** on page 52.

- **ASCII** - In this ASCII protocol each command and response is a string of ASCII characters. This proprietary protocol is developed by Contrec to allow for simple information interchange. The main advantages of this mode are that it allows extended time intervals to occur between characters without causing a timeout error and that messages can be sent and monitored easily with a simple ASCII terminal.
- **Modbus RTU** - Modbus RTU is an industry-standard protocol which allows the instrument to be easily connected to computers running supervisory software systems. The main advantage of this mode is that its greater character density allows better data throughput than ASCII mode, however each message must be transmitted in a continuous stream.
- **Printer** - In the Printer protocol there is a selection of printer types. Please refer to the **Printer Protocol** on page 76 for full details.

## Simple ASCII Protocol

**Note:** Not all ASCII commands are applicable for Batch Controller applications.

This simple ASCII protocol requires that all requests are initiated with a colon (:) and terminated with a carriage return ( $C_R$ ). The message termination can include a linefeed before the carriage-return ( $L_F C_R$ ), but it is the carriage-return that acts as the message termination.

All responses by the instrument are terminated with a linefeed and a carriage-return ( $L_F C_R$ ).

## Requests Format

The format of a request to the instrument is as follows:

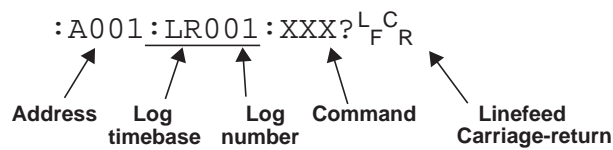

Each request must include the address and command portions. The underlined section is an optional part of the request string.

### Address

In multipoint communications, each instrument must have a unique address and it is essential in the request for identifying a particular instrument. However, it may be set to 000, for special broadcast commands. For single-instrument communications, the address can also be set to 000 in the request.

Refer to **Communications** on page 52 for setting the instrument address.

**Note:** The instrument always responds with its address in the header regardless of the type of request.

### Log Type and Number

The log type and number enables a communicating device to retrieve data from the instrument. The data can be from the event-based logs or from the current process variables with the either accumulated or non-accumulated (resettable) totals.

The log request is optional. If the log request is not included, or the log number is set to 000, the instrument returns the current process variables. If the log request is included, the log number defines the specific log entry by counting backwards. The most recent log entry for a timebase is 001.

The “last edit” log records the process variables at the time of the last exit from the calibration edit mode. There is only one “last edit” log, therefore, if a number is included in the request, the instrument ignores the number and returns the data at the time of the last edit. Likewise, there is only one set of current process variables with “non-accumulated totals”, therefore it also ignores any log number included in that request.

The types of the logs applicable to this instrument are as follows:

Log Type
LE - last edit log
LR - logged records (non-timebased logging)
LN - current totals displayed as Non-accumulated

The number of the log entry is the same as shown on the front panel of the instrument. For example, a request for LR003 would return the data for the log entry two batches prior to the most recent batch log entry.

## Instrument Responses

The instrument response time to any enquiry is not more than 300ms. The responses from the instrument are in the following format:

```

HEADERLFCR
DATALFCR
DATALFCR
.
.
.
DATALFCR
LFCR
    
```

The components of the response message are as follows:

### Header

The format of the response header from the instrument is as follows:

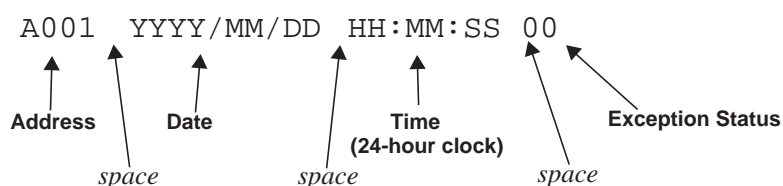

The instrument **Exception Status** codes that the instrument returns for the ASCII protocol are the same as those described for the Modbus RTU protocol in **Instrument Exception Status** on page 72.

### Data

The format of the data variables from the instrument is as follows:

8 9 1 2 3 . 4 5 6								M 3			V O L U M E														
1	2	3	4	5	6	7	8	9	10	11	12	13	14	15	16	17	18	19	20	22	23	24	25	26	27
Value (aligned right)											<i>space</i>	Unit (aligned left)						<i>space</i>	Item (aligned left)						

**Note:** The decimal point in the Value is always at character position 8.  
Therefore whole numbers are aligned right at the decimal point, with trailing zeroes.

**Variables Request**

The variables request asks the instrument to return the value of one or more requested variables. All totals are transmitted as accumulated totals.

Command	Description
:RVA?	Return all variables
:RVD?	Return the default Total and Rate
:RV0? ... :RV9?	Return the specific variable. The numbers relate to the position in the variables menu. For example, V0 is Energy, V1 is Power and so on.

**Variables Request and Response Example**

The following request is for the only instrument that is connected to the communication port to return the values of all main menu variables.

: A 0 0 1 : R V A ? <sup>L<sub>F</sub></sup> <sup>C<sub>R</sub></sup>

The following is an example of a hypothetical instrument response. Refer to on page 3 for the list of variables that would be returned for this application.

```

A 0 0 1   2 0 0 2 / 0 3 / 1 4   1 8 : 2 5 : 0 0   0 0 LF CR
           6 . 1 1 6   M W h           E N E R G Y   LF CR
           1 6 . 5 7 3   M W           P O W E R   LF CR
    1 3 2 0 . 5 3 0   m 3           V O L U M E   LF CR
           5 8 . 3 0 0   m 3 / M       V - F L O W   LF CR
    7 6 2 7 . 1 1 7   K G           M A S S   LF CR
           3 4 4 . 4 6 0   K G / M     M - F L O W   LF CR
           2 3 0 . 0 0 0   D E G   C   T E M P   LF CR
           1 . 2 6 0   M P A           P R E S S   LF CR
           0 . 1 7 4   m 3 / K G       S P - V O L   LF CR
    2 8 8 6 . 7 6 0   K J / K G       S P - E N T   LF CR
LF CR
    
```

The following message to an instrument, requests the current values for the default rate and total:

: A 0 0 1 : R V D ? <sup>L<sub>F</sub></sup> <sup>C<sub>R</sub></sup>

The instrument response would be similar to the following:

```
A 0 0 1 2 0 0 2 / 0 3 / 1 4 1 8 : 2 5 : 0 0 0 0 LF CR
      1 2 6 . 4 5 5 m 3 V O L U M E LF CR
      2 0 . 4 3 7 m 3 / M V - F L O W LF CR
LF CR
```

### Log Request

The log request asks the instrument how many logs will be included in a printed log report. These are the values described in [Time Settings and Data Logging](#) on page 54.

Command	Description
:RLR?	Return the number of log records (non- timebased logging)

### Log Response Example

The following message asks the instrument with address 001 to return the number of logs that the instrument stores:

```
: A 0 0 1 : R L R ? LF CR
```

The instrument response would be similar to the following:

```
A 0 0 1 2 0 0 2 / 0 3 / 1 4 1 8 : 2 5 : 0 0 0 0 LF CR
2 4 LF CR
LF CR
```

### Clear Data Request

The clear data request asks the instrument to clear the data in the selected registers.

Command	Description
:RCN?	Clear the non-accumulated (resettable) totals
:RCA?	Clear the accumulated totals
:RCL?	Clear the logs except for the “last edited” log

### Clear Data Request Example

The following message asks the instrument with address 001 to clear the logged data that the instrument stores:

```
: A 0 0 1 : R C L ? LF CR
```

The instrument response would be similar to the following:

```
A 0 0 1 2 0 0 2 / 0 3 / 1 4 1 8 : 2 5 : 0 0 0 0 LF CR
LF CR
```

### Instrument Information Request

The Instrument Information request asks the instrument to return the general information about the model and version codes. The instrument exception status is returned as a part of the header as it is with the header for all command responses.

Command	Description
:RIG?	Return the general information about the instrument such as Model number, Application number, Version and Serial numbers etc. These items are returned as a block in the same format as shown on the display in the “Model Info” menu.

### Instrument Information Response Example

The following message asks the instrument with address 001 to return the general information about the instrument:

```
: A 0 0 1 : R I G ? LF CR
```

The following is an example of a hypothetical instrument response:

```
A 0 0 1 2 0 0 2 / 0 3 / 1 4 1 8 : 2 5 : 0 0 0 0 LF CR
5 1 5 M O D E L - 1 1 - F - LF CR
S C 0 1 I N P U T F - T P - - LF CR
S C 0 1 V E R S 0 1 0 1 . 0 0 1 LF CR
C U S T O M V E R S 0 0 0 0 0 1 LF CR
U N I T S / N 1 2 3 4 5 6 LF CR
LF CR
| 1 | 2 | 3 | 4 | 5 | 6 | 7 | 8 | 9 | 10 | 11 | 12 | 13 | 14 | 15 | 16 | 17 | 18 | 19 | 20 | 21 | 22 | 23 | 24 | 25 | 26 | 27 | 28 | 29 |
```

## Corrupted or Invalid Requests

If the instrument receives a corrupted or incomplete request, there is no response. The instrument discards any partial request and waits for the next enquiry.

If the instrument receives a request message in the correct format, but for a non-existent option, it returns only the message header. For example, if the instrument received the following request variables message :A001:RVT? it will return only the header because there is no T option for the ‘Variables Request’ message.

## Modbus RTU Protocol

Modbus RTU (remote terminal unit) is an industry standard protocol that allows the instrument to be easily interfaced to other communication devices.

The instrument implements the Modbus protocol as detailed in the *Modicon Modbus Protocol Reference Guide* PI-MBUS-300 Rev J (June 1996).

### Message Format

In RTU mode, messages start with a silent interval of at least 3.5 character times. The first field transmitted is the device address. Following the last transmitted character, a similar interval of at least 3.5 character times marks the end of the message. A new message can begin after this interval. The entire message frame must be transmitted as a continuous stream. A typical message frame is shown below:

Address	Function	Data	CRC Check
1 byte	1 byte	n bytes	2 bytes

Except for broadcast messages, when a master device sends a query to a slave device, it expects a normal response. One of four possible events can occur from the master's query:

- If the slave device receives the query without a communication error, and can handle the query normally, it returns a normal response.
- If the slave does not receive the query due to a communication error, no response is returned. The master program has to process a timeout condition for the query.
- If the slave receives the query, but detects a communications error (parity or CRC), no response is returned. The master program has to process a timeout condition for the query.
- If the slave receives the query without a communication error, but cannot handle it (for example, if the request is to read a nonexistent register), the slave will return an exception response informing the master of the nature of the error.

### Instrument Address

The address of the instrument is programmable in the range from 1 to 247. Some addresses are reserved according to PI-MBUS-300 and have a special meaning:

- 0 = Broadcast, no response required from slave devices
- 248 to 255 Reserved

## Function Codes

The instrument accepts the following function codes:

Code	Name	Description
03	Read data register(s)	Obtain the content of one or more 2-byte data registers.
06	Preset data register	Preset one 2-byte data register.
07	Read status register	Obtain the content of 1-byte status register.
16	Preset data register(s)	Preset one or more 2-byte data registers.

## Exception Response

The instrument forms an exception response by adding 80H to the function code and using an exception code as the 1-byte data field in the returned frame. Implemented exception codes are as follows:

Code	Name	Description
01	Illegal function	The function code is not a legal action for the slave.
02	Illegal data address	The data address is not a legal address for the slave.
03	Illegal data value	The data value is not a legal value for the slave.
05	Acknowledge	The slave has accepted the request and is processing it, but a long duration of time will be required to do so.
06	Slave device busy	The slave is engaged in processing a long duration program command. The master should re-transmit the message later when the slave is free.

## List of Data Registers

The following list describes the addresses and meaning of the data registers in the instrument. The data values are expressed in the engineering units that were selected for the variables when the instrument settings were configured. The “Data Type” for the 2-register (4-byte) data values can be set in programming mode as Floating Point or Long Integer as described in **Communications** on page 52.

The registers are grouped in blocks that relate to a particular function of the instrument.

**Note:** Conventional numbering of registers often starts from 1, therefore be aware that “register 1” in this case has “address 0” and so on.



### Current and Logged Process Data

This block of registers is available for the retrieval of current or logged process data with its matching time and date information.

Use the log timebase and log number to retrieve the logged information from the appropriate register. If a particular log number does not exist, or the instrument does not have the optional real-time clock, the time and date stamp and associated variables are set to zero.

Register	Name	Comments	Read Only or Read/Write	Type
1	Net Volume	Process Variables  By default totals are the Accumulated values. If current Non-accumulated (resettable) totals are required, set register 37 to 06.	R	DT*
3	Net Flowrate		R	DT
5	Main Line Volume		R	DT
7	Main Line Flowrate		R	DT
9	Process Line Volume		R	DT
11	Process Line Flowrate		R	DT
13	Volume Ratio		R	DT
15	Flowrate Ratio		R	DT
17	Process Control Output		R	DT
19	Process Flowrate Deviation		R	DT
21			R	DT
23			R	DT
25			R	DT
27			R	DT
29			R	DT
31	Year	Current Date/Time or Logged Date/Time Stamp (see register 38 Log Number). Only current Date/Time can be edited	R/W	I†
32	Month		R/W	I
33	Date		R/W	I
34	Hour		R/W	I
35	Minute		R/W	I
36	Second		R	I
37	Log Type	00 - hourly or log records 01 - daily 02 - weekly 03 - monthly 04 - yearly 05 - last edit of calibration 06 -current totals are non-accumulated values, register 38 is ignored.	R/W	I
38	Log Number	If set to 0, current variables and Date/Time are retrieved	R/W	I
39	Clear Data	01 - clear logs 02 - clear accumulated totals 03 - clear non-accumulated totals	W	I
40	Reserved			

\* DT = Data Type of 2-register (4 byte) values can be set as Floating Point or Long Integer values

† I = Integer (2 bytes) (Holding Registers)

**Note:** The Floating Point variable is represented in IEEE-754 Floating Point 4-byte format and requires two 2-byte data registers:

IEEE-754	Modicon Registers
1st byte	low byte (register X)
2nd byte	high byte (register X)
3rd byte	low byte (register X+1)
4th byte	high byte (register X+1)

This means that two data registers must be read or written to obtain, or preset, one data value.

### Instrument Exception Status

This register is available to verify the status of the instrument.

Register	Name	Comments	Read Only or Read/Write	Type
41	Exception Status	00 = no error 01 = analog input 1 failure 02 = analog input 2 failure 03 = analog input 3 failure 04 = analog input 4 failure 05 = invalid calibration parameter 06 = invalid reference parameter 07 = invalid property 08 = quadrature input error 09 = quadrature input frequency over limit 10 = process parameters out of range 11 = input is over limit 12 = no flow error detected 13 = overflow error detected 14 = leakage error detected 20 = system failure 21 = power supply is low 22 = new or failed clock battery 23 to 29 reserved 30 = alarm 1 active 31 = alarm 2 active 32 = alarm 3 active 33 = alarm 4 active	R	I*

\* I = Integer (2 bytes) (Holding Registers)

### Instrument Control and I/O

This block of registers is available in some applications to give access to important information in the instrument.

Register	Name	Comments	Read Only or Read/Write	Type
42	Reserved		R	I*
43	Logic Inputs	0 to 15 Binary representation of logic inputs  B0 = 0/1 (LSB)    input 1 activated/deactivated B1 = 0/1            input 2 activated/deactivated B2 = 0/1            input 3 activated/deactivated B3 = 0/1            input 4 activated/deactivated	R	I
44	Operation State	Representation of operation status  0 = Reset 1 = Maintenance 2 = Completed 3 = Waiting to restart 4 = Paused 5 = Waiting for timeout 6 = Running (Slow Start) 7 = Running (Prestop) 8 = Running (Full Flow)	R	I
45	Relay State	0 to 15 Binary representation of relay state. 0 = open; 1 = closed.  B0 = relay 1 (LSB) B1 = relay 2 B2 = relay 3 B3 = relay 4	R	I
46	Relay Control	0 to 15 Binary representation of relay control. 0 = open; 1 = close.  <b>Note:</b> Only the general relays configurable in the Alarm section of calibration are able to be viewed and controlled by Modbus.  B0 = relay 1 (LSB) B1 = relay 2 B2 = relay 3 B3 = relay 4	R/W	I
47	Relay Control Source	0 to 15 Binary representation of relay control source. 0 = Local (controlled by instrument operation) 1 = RTU (controlled by Modbus register 46).  B0 = relay 1 (LSB) B1 = relay 2 B2 = relay 3 B3 = relay 4	R/W	I
48	Delivery Number	Provides the delivery number (batch record) for a stored transaction (determined by Modbus register 38).	R	L†
50	Control Mode	0 = Idle/Local    Control from logic inputs 1 = Stop            Suspend current batch 2 = Run             Resume/start batch 3 = Reset           Clear current batch totals	R/W	I
51 to 99	Instrument Parameters	See next table for details.	R/W	DT‡

Register	Name	Comments	Read Only or Read/Write	Type
101	Analog Inp.1	Raw analog input data.	R	DT
103	Analog Inp.2	4-20mA inputs are read in Amperes.	R	DT
105	Analog Inp.3	0-5V or 1-5V inputs are read in Volts	R	DT
107	Analog Inp.4	RTD inputs are read in degrees Kelvin. Unused inputs are configured as 4-20mA.	R	DT

\* I = Integer (2 bytes) (Holding Registers)

† L = Long Integer (2 register = 4 bytes)

‡ DT = Data Type of 2-register (4 byte) values can be set as Floating Point or Long Integer values

## Instrument Configuration Parameters

This block of registers is available in applications to give access to some important instrument parameters (i.e. fluid properties etc.).

The usage of these parameters can be dependent on other instrument settings. For full description, please refer to the [Modbus Accessible Parameters](#) on page 44.

Register	Name	Comments	Read Only or Read/Write	Type
51	Preset Control Output Setpoint		R/W	DT
53	Preset Flowrate Setpoint		R/W	DT
55	Preset Ratio Setpoint		R/W	DT
57	Batch Preset Value		R/W	DT
59 to 99	Reserved		R/W	DT

## Printer Protocol

A printer protocol is available in the 500 Series. It provides the ability to print out live data, individual logged data and to do some report-style printing of logged data. The method of printing these and the format of the printouts is described below.

**Note:** Printer output is only available if the Real Time Clock option is fitted.

The selection of Printer Protocol can be made for the Communications Protocol options for the RS232 or RS485 port. A list of log report types and printer types available at the end of the TM-LOG calibration menu.

### Report Types

The list of report types is as follows:

- REP-10 Latest Logs Report

The number of logs printed in each report are determined by the values programmed for Report Logs in the TM-LOG menu.

### Printer Types

The list of available printers is as follows:

- PRN-01 Generic computer printer
- PRN-02 Generic roll printer (printing first line first)
- PRN-03 Slip Printer TM295
- PRN-04 Label (roll) printer - Citizen CMP30L

### Customizing a Printout

A customized printout can be provided which can have up to 4 header lines and 3 footer lines. It is also possible to include or exclude each main menu items on the printout. If any customizing of the printout is required discuss this with the distributor.

## Types of Printouts

### Live Data

The HOLD.SET - TO PRINT prompt in the main menu, is used to initiate a printout of the current delivery if the printer protocol has been selected. A printout can only be initiated if a batch is not in progress. If printing is not required, do not select printer protocol.

The format of this printout will be:

*Custom Header Line 1*  
*Custom Header Line 2*  
*Custom Header Line 3*  
*Custom Header Line 4*

*Instrument Serial No. & Tag*

*Current Delivery No.*  
*Current Date & Time & Status*  
*Variable                    unit    value*  
*Variable                    unit    value*  
*etc.*

*Custom Footer Line 1*  
*Custom Footer Line 2*  
*Custom Footer Line 3*

----- <separation line>

(Note that blank header and footer lines are not printed).

### **Instrument Serial Number and Unit Tag**

The instrument serial number and unit tag is the same as the information shown in the Model Info menu. For more details refer to **Model Information** on page 22

### **Delivery Number**

The delivery number that appears on the live data printout shows the assigned delivery number that is stored with the logged data. This number is cleared when the Logs are cleared in the TM/LOG menu. If a second print or docket of the same delivery is generated, the words “(DUPLICATE DOCKET)” are included at the top of the printout. i.e.

*(DUPLICATE DOCKET)*

*#####*

*DELIVERY No.    000256*

### **Individual Log Data**

When in the Log Menu and while holding the DISPLAY key to view the data of the log of interest, the RESET key can be pressed to initiate a printout of that log entry. The printout will have the time and date stamp corresponding to when the log was taken. After the print has been initiated there will be the opportunity to scroll to view another log entry and print again.





----- <separation line>

*Delivery No.*  
*Date & Time & Status*  
*Variable            unit    value*  
*Variable            unit    value*

*ETC*

*Custom Footer Lines*

----- <separation line>

Reports such as “Latest Logs” will print in the historical order, and for those logs that have no data (e.g. unit was powered off at the time) the print will show “Data not available”. i.e.

----- <separation line>

*Del No.    Data Not Available*

----- <separation line>

*Delivery No.*  
*Date & Time & Status*  
*Variable            unit    value*  
*Variable            unit    value*  
*etc.*

If the unit is programmed for 0 logs for the latest log reports then the report will only consist of the header and ID information and a “Data Not Available” message.

*Custom Header Lines*

*Title of Report*

*Current Date & Time*  
*Instrument Serial No. & Tag*

*Data Not Available*

*Custom Footer Lines*

----- <separation line>

## Printer Data Control

Some printers have limited data buffers and are therefore unable to collect all the print data being transmitted. The 500 Series has the capability of software handshaking. The Xon/Xoff characters can be used by any of the printer types to control the flow of data to ensure that data is not lost.

Some printers will also transmit an Xoff character in response to other events such as printer being off-line, print head not engaged or power being removed. The specific behaviour of the printer being used should be noted.

## **Error Messages**

There are two printer error messages that can be displayed.

### **PAPER OUT**

This message is related to the Printer Type PRN-03 TM295 Slip printer. It is standard procedure with this printer to check for paper status before printing. If a print is attempted but there is no paper the PAPER OUT message will be scrolled. The instrument will continue to poll the printer for paper and if paper is detected before a communications timeout expires the print will commence.

### **COMMS TIMEOUT**

This message is relevant for all printer types and will be activated for the following conditions.

1. If the flow of data is stopped due to software or hardware handshaking and is not allowed to resume before the communications timeout.
2. If Printer Type is PRN-03 Slip printer and a paper status is requested but no response is received within the timeout period.
3. Paper Out has been detected for Printer Type PRN-03 but no paper is inserted within the timeout period.

When communications timeout error has been activated the message COMMS TIMEOUT will be scrolled once, the request to print will be cleared and the instrument will return to its normal mode.

# Appendix A

## Glossary

---

<b>ASCII</b>	American Standard Code for Information Interchange. For the ASCII protocol, the instrument receives and transmits messages in ASCII, with all command strings to the instrument terminated by a carriage return. Replies from the instrument are terminated with a line-feed and a carriage-return.
<b>Filtering</b>	The process of suppressing oscillations or random signals in the input signal.
<b>IrDA</b>	The Infra-red Developers Association is a group of computer and software manufacturers who have agreed on a format for communication among infrared devices.
<b>Linear Correction</b>	A scaling of the input signal to represent the actual flow parameter.
<b>Modbus RTU</b>	The Modbus protocol is a message structure for communications between controllers and devices regardless of the type of network. In RTU (remote terminal unit) mode, each 8-bit byte in a message contains two 4-bit hexadecimal characters. This mode has greater character density than ASCII and allows better data throughput than ASCII for the same baud rate.
<b>Normalised Input</b>	A normalised input ranges from 0 to 1.000. For 4-20mA input, the signal is set to 0 at 4mA and the signal is set to 1.000 at 20mA.
<b>Passive Output Signal</b>	Requires an external power supply.



# Appendix B

## Model Numbers

### Product Codes

Model	Supplementary Code	Description
515	- BR02	
Enclosure	1	Panel mount enclosure
	2	Field mount enclosure (NEMA 4X / IP66)
	3/5	Explosion proof Ex d (IECEX/ATEX), metric glands (5 specifies heater)
	4/6	Explosion proof Ex d (CSA), NPT glands (6 specifies heater)
Output Options	0	4 logic inputs, 1 isolated output, 2 relays (only relay type 1 is available), RS232 (DB9) communication port
	1	4 logic inputs, 2 isolated outputs, 4 relays, real-time clock data logging, RS232 (DB9) and RS485 communication ports
	2/3	4 logic inputs, 2 isolated outputs, 4 relays, real-time clock data logging, RS232 (DB9) and Ethernet/RF communication ports (not yet available)
Relay Type	1	Electromechanical relays only
	2	2 electromechanical and 2 solid state relays
	3	Solid state relays only (not yet available)
Power Supply	U	Inputs for 12-28VDC and 100-240 VAC, 50-60Hz <i>(Previous Models: A = 110/120 VAC, E = 220/240 VAC)</i>
	D	Input for 12-28VDC power only
Display Panel Options	S	Standard option (now with backlight & LCD backup) <i>(original Full option: F, with Infra-Red comms, no longer available)</i>
PCB Protection	C	<b>Conformal coating</b> - required for maximum environmental operating range. Recommended to avoid damage from moisture and corrosion.
	N	<b>None</b> - suitable for IEC standard 654-1 Climatic Conditions up to Class B2 (Heated and/or cooled enclosed locations)
Application Pack Number	BR02	Defines the application software to be loaded into the instrument
For example: Model No. 515.111USC Displayed on the 500 Series as: Note: The first character represents the CPU installed (factory use only). The remaining 6 characters only represent hardware that affects the operation.		

**Note:** Example full product part number is 515.111USC-BR02 (this is the number used for placing orders).

## Custom Version Codes

	Code		Description
<b>Origin Code</b> <b>Identifies Distributor</b>	00		Factory Default Application
	01		Contrec Systems Pty. Ltd. Melbourne Australia
	02		Contrec Limited. West Yorkshire UK
	03		
	04		Contrec-USA, LLC. Pelham AL 35124 USA
	05		Flowquip Ltd. Halifax UK
	06		
	etc.		
<b>User Language</b>	0		English (Default)
	1		German
	2		Dutch
	3		French
	4		Spanish
	5		
	etc.		
<b>Distributor's Code</b>	000		Distributor's own choice. Possibly a code that identifies the customer and the application.
	...		
	999		
For example: 02 3 157 Displayed on the 500 Series as:			<b>023 157</b> CUSTOM VERS

## Application Information Code

The Application Information code is an aid for users and service personnel to determine the type of inputs that are used in a particular application. The Application Information code is displayed on the instrument as shown below.

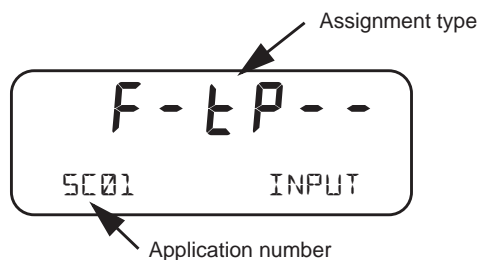

The Application Information code is returned as part of a General Instrument request (as described in [Instrument Information Request](#) on page 68).

---

The Application number identifies the application as in the following examples:

- SC01 - steam flow computer for frequency flow meter
- GN02 - natural gas flow computer for analog flow meter

The Input Assignment type indicates the physical input that is assigned to each input on the instrument. The code is made up from six characters as follows:

<b>FINP1</b>	<b>FINP2</b>	<b>AINP1</b>	<b>AINP2</b>	<b>AINP3</b>	<b>AINP4</b>
<b>X</b>	<b>X</b>	<b>X</b>	<b>X</b>	<b>X</b>	<b>X</b>

The codes are as follows:

- - - not used in this application
- *A* - indicates a generic analog input such as for density or level
- *d* - indicates a density input
- *F* - indicates a generic flow input such as for volume or mass, (frequency or analog)
- *H* - indicates a high flow input for stacked inputs
- *L* - indicates a low flow input for stacked inputs
- *P* - indicates a pressure input
- *q* - indicates a quadrature input
- *t* - indicates a temperature input.

For example, *F - t P - -* is an instrument with FINP1 (frequency input 1) assigned to a flow input, AINP1 assigned to a temperature input and AINP2 assigned as a pressure input. The other inputs are not used.

# Appendix C

## Units of Measurement

### Available Units of Measurement

The following is a list of the available units of measurement used across the range of 500 Series applications.

Units Type	Available units of measurement
Volume	m <sup>3</sup> , Km <sup>3</sup> , Ltr, mL, Gal, KGal, MGal, ft <sup>3</sup> , kft <sup>3</sup> , Mft <sup>3</sup> , bbl
Volume Flowrate	m <sup>3</sup> /s, m <sup>3</sup> /min, m <sup>3</sup> /h, m <sup>3</sup> /D, L/s, L/min, L/h, L/day, mL/s, mL/min, mL/hr, Gal/s, Gal/min, Gal/h, KGal/D, MGal/D, ft <sup>3</sup> /s, ft <sup>3</sup> /min, ft <sup>3</sup> /h, Mft <sup>3</sup> /D, bbl/s, bbl/min, bbl/h, bbl/D
Volume K-Factor	P/m <sup>3</sup> , P/Ltr, P/mL, P/Gal, P/ft <sup>3</sup> , P/bbl
Mass	kg, g, Ton, lb, Klb
Mass Flowrate	kg/s, kg/min, kg/h, g/s, g/min, g/h, Ton/min, Ton/h, Ton/D, lb/s, lb/min, lb/h, Klb/min, Klb/h, Klb/D
Mass K-Factor	P/kg, P/g, P/Ton, P/lb, P/Klb
Energy	kJ, MJ, GJ, kWh, MWh, kBTU, Ton.h, therm, cal, kcal, Mcal
Power	kJ/h, MJ/h, GJ/h, kW, MW, kBT/M, kBT/h, Ton, therm/min, therm/h, kcal/h, Mcal/h
Energy K-Factor	P/kJ, P/kWh, P/kBTU, P/Ton.h, P/therm, P/kcal
Temperature	Deg K, Deg C, Deg F, Deg R
Pressure	Pa, kg/m <sup>2</sup> , kg/cm <sup>2</sup> , kPa, MPa, mbar, bar, psi, Atm, inH <sub>2</sub> O, mmH <sub>2</sub> O
Density	kg/m <sup>3</sup> , kg/Ltr, lb/ft <sup>3</sup> , SG60F
Specific Volume	m <sup>3</sup> /kg, L/kg, ft <sup>3</sup> /lb
Specific Enthalpy	kJ/kg, BT/lb, cal/g, cal/kg, kcal/kg, Mcal/kg
Reynolds Number	E+0, E+3, E+6 (scaling for unitless variable)
Length (Level)	m, mm, cm, INCH, FOOT
Velocity	m/s, m/M, m/h, ft/s, ft/M, ft/h
Length K-Factor	P/m, P/cm, P/INCH, P/FOOT
Area	m <sup>2</sup> , ft <sup>2</sup>
Ratio	%
General Input	Pressure, Temperature, Density, Length (Level), Factor



# Index

---

## Numerics

4-20mA  
output 13

## A

address, instrument 64  
alarm  
delay 52  
equipment failure 51  
hysteresis 52  
relays 51  
setpoint 51  
alarms menu 51  
analog input  
connections 11  
application code 84  
approvals 4  
FCC Declaration 5  
ASCII protocol 63

## B

back panel 10  
batch  
configurations 28  
errors 30  
operations 31  
reset 30  
start 29  
stop 29  
batch control 28  
BATCH key 18  
batch limit 20  
batch modes 26  
batch preset  
common values 20  
batch processes 31  
battery  
failed 60  
life 54  
new 60  
baud rate 53

## C

calibration  
menu 38  
set mode 36  
view mode 35  
clock  
battery 54  
date format 55  
real-time 54  
codes  
application information 84  
customer version 84  
exception 72  
product number 83  
common preset values 20  
communication  
connections 15  
protocols 63  
communications 3, 61  
menu 52  
connecting permissive 29  
connections  
communication 61  
communications 15  
control relays 14  
electrical 10  
input 11  
output 12  
control loop  
tuning 25  
control modes 22  
customer version codes 84  
customizing a printout 76

## D

data log  
viewing 20, 21  
date format 55  
declaration FCC 5  
default variable 18  
delay, alarm 52  
digital output 13

---

display  
  specifications 7  
  timeout mode 57  
  timeout time 57  
DISPLAY key 18  
display-only parameter 35

**E**  
earthing 16  
edit batch preset 20  
electrical connections 10  
equipment failure alarm 51  
error messages 59  
exception codes 72  
Exception Status 65

**F**  
features 1  
flash driver port assignment 54  
format, date 55  
front panel 17  
  keys 18  
  LEDs 18

**G**  
glossary 81

**H**  
hardware connections 61  
hysteresis, alarm 52

**I**  
infra-red port 52  
input  
  connections 11  
    analog 11  
inputs menu 45  
installation 9  
instrument  
  address 64  
  request format 64  
  responses 65  
  settings 40  
interconnections, communication 61  
interference suppression 15  
isolated outputs 3

**K**  
key  
  BATCH 18  
  DISPLAY 18  
  RESET 18  
  RUN 18  
  SET 20  
  STOP 18  
  TOTAL 18  
keys, front panel 18

**L**  
LEDs, status 18  
logged data 20  
  viewing 21  
logic input connection 12  
logic input control 30

**M**  
main menu items 19  
menu  
  alarms 51  
  calibration 38  
  comms 52  
  inputs 45  
  outputs 48  
  params 41  
  setup 56  
  test 58  
  tm/log 54  
  units 40  
messages  
  error 59  
  prompts 60  
  system 59  
  warning 60  
Modbus accessible parameters 44  
Modbus data format 53  
Modbus RTU protocol 69  
mode  
  display timeout 57  
  process control 22  
  set calibration 36  
  view calibration 35  
model numbers 83  
modes, batch control 26  
mounting 9

---

## N

### number

- model 83
- serial 22

## O

- on-off mode 27
- operation configurations 28
- operation, batch control 28
- operation, control modes 22
- operation, front panel 17
- output
  - connections 12
    - 4-20mA 13
    - digital 13
  - pulse factor 50
- outputs menu 48

## P

- panel
  - LEDs 18
  - mounting 9
  - rear 10
- parameter
  - display-only 35
  - not visible 35
  - password-protected 35
  - programmable 35
- parameters menu 41
- parity bits 53
- password-protected parameter 35
- permissive
  - connect 29
- permissive input 29
- port
  - assignment, flash driver 54
  - flash driver assignment 54
  - infra-red 52
  - RS-232 15, 52, 61
  - RS-485 16, 52, 53, 62
- power supply interruption 54
- preset batch value 20
- preset mode 26
- printer
  - data control 79
  - error messages 80
  - protocol 76
  - report types 76
- printer types 76

## printouts

- individual logs 77
- live data 76
- log report 78
- types 76
- product number codes 83
- programmable parameters 35
- prompts 60
- protocol
  - ASCII 63
  - communication 63
  - Modbus RTU 69
  - printer 76
- pulse factor, output 50

## R

- real-time clock 54
- rear panel 10
- relay
  - connection 14
- relay outputs 3
- relays, alarm 51
- release mode 27
- remote control 30
- RESET key 18
- resetting a batch 30
- responses, instrument 65
- RS-232 port 15, 52, 61
- RS-485 port 16, 52, 53, 62
- RTU protocol 69
- RUN key 18

## S

- safety & security 29
- serial number 22
- SET key 20
- setpoint, alarm 51
- settings
  - instrument 40
- setup menu 56
- shielding 16
- snubber 15
- specifications 7
- standards 4
- starting a batch 29
- status LEDs 18
- stop bits 53
- STOP key 18
- stopping a batch 29

---

suppression, interference 15

system

errors 59

messages 59

prompts 60

warnings 60

## **T**

terminal designations 10

test menu 58

timeout

mode 57

time 57

tm/log menu 54

TOTAL key 18

tuning control loop 25

## **U**

unit tag 22

units

menu 40

## **V**

variable, default 18

version, customer 84

view data logs 20, 21

## **W**

warnings 60