

Model 515 Flow Computer

Operation Manual

Application CB02

Blending Controller
for
Volumetric Frequency Flowmeters

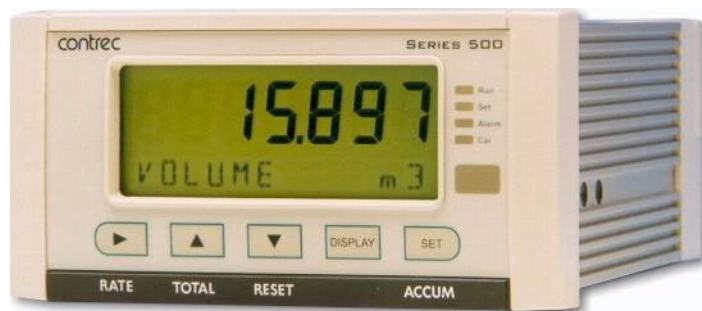

contrec

26 March 2009

Model 515 Flow Computer - Operation Manual

© Contrec Pty Ltd 2008

The instructions given herein cover the general description, installation, operation and maintenance of the subject equipment. Contrec Pty. Ltd. reserves the right, without prior notice, to make engineering refinements that may not be reflected in this manual.

Should any questions arise which cannot be answered specifically by this manual, they should be directed to Contrec Pty Ltd for further detailed information and technical assistance.

Contrec Pty. Ltd. will not accept any liability for either direct or consequential damages resulting from the use or misapplication of the contents of this manual.

Part of the software embedded in this product is eCos - Embedded Configurable Operating System, a trademark of Red Hat. Portions created by Red Hat are Copyright © 1998, 1999, 2000 Red Hat, Inc. (<http://www.redhat.com>). All rights reserved

The software in this product was in part provided by Red Hat and any express or implied warranties, including, but not limited to, the implied warranties of merchantability and fitness for a particular purpose are disclaimed. In no event shall the author be liable for any direct, indirect, incidental, special, exemplary, or consequential damages (including, but not limited to, procurement of substitute goods or services; loss of use, data, or profits; or business interruption) however caused and on any theory of liability, whether in contract, strict liability, or tort (including negligence or otherwise) arising in any way out of the use of this software, even if advised of the possibility of such damage.

Contrec Pty Ltd

22 Hall Street Hawthorn East, Melbourne 3123 AUSTRALIA
Tel: +61 3 9804 4200 Fax: +61 3 9822 8329
Email: sales@contrec.com.au

Contrec - USA, LLC

916 Belcher Drive Pelham AL 35124 USA
Tel: (205) 685 3000 Fax: (205) 685 3001
Email: contrec@contrec-usa.com

Contrec Europe Limited

PO Box 436 Sowerby Bridge, West Yorkshire HX6 3YA, UK
Tel: +44 1422 829 940 Fax: +44 1422 829 941
Email: sales@contrec.co.uk

Website: www.contrec.com.au

Publication No: 515-CB02-OM - 26 March 2009



Safety Notice

The information in this safety notice is for the prevention of injury to personnel and damage to the instrument.

The manufacturer assumes no liability for injury or damage caused by misuse of the instrument or for modifications made to the instrument.

Qualified Personnel

The instrument must be installed, operated and serviced by persons who have been properly trained and authorised. Personnel must read and understand this manual prior to installation and operation of the instrument.

Static Hazard

The 500 series flow computer uses high speed CMOS circuitry which is sensitive to static damage. The user should observe accepted safety practices for handling electronic devices, especially during servicing. Once the unit is installed, grounded and interconnected, the chances of static damage are greatly reduced.

Voltage Hazard

Before connecting power to the instrument, ensure that the supply voltage for the AC or DC input is suitable. The AC voltage rating is as stated on the serial number plate. Personnel should take all due care to avoid electric shock.

Welding Hazard

Do not perform electric welding in close proximity to the instrument or its interconnecting cables. If welding in these areas must be performed, disconnect all cables from the instrument. Failure to do so may result in damage to the unit.

Moisture Hazard

To avoid electrical faults and corrosion of the instrument, do not allow moisture to remain in contact with the instrument.

Contents

1 Introduction

Features	1
Overview	1
Calculations	2
Analog Input Scaling	2
Displayed Information	2
Main Menu Variables	3
Communications	3
Isolated Outputs	3
Relay Outputs	3
Software Configuration	4
Approvals	4

2 Specifications

Specification Table	5
---------------------	---

3 Installation

Panel Mounting	7
Electrical Connection	8
Rear Panel Connections	8
Terminal Designations	8
Inputs	9
Frequency Input Connection	9
Analog Input Connections	10
Logic Input Connection	12
Outputs	12
4-20mA Output Connection	13
Pulse Output Connection	13
Control Relays (Alarms)	14
RC Network for Interference Suppression	15
Communications	15
RS-232 Port	15
Infra-red Port	16
RS-485 Port (Optional)	16
Earthing and Shielding	16

4 Operation

Normal Operation Mode	17
Default Variable & Total	17
Status Lamps	18

Front Panel Keys	18
Main Menu Items	18
Simplified Main Menu	19
Peak Flowrates	20
User Value	20
Setpoints	20
Data Logs	20
Model Information	21
Blending Operation	22
Typical Blending Configurations	23
Resetting Totals	24
Logic Input Control	24
ID Tag Validation	24
Digital Control Valve Connection	24
Blending Errors	25

5 Instrument Calibration

Introduction	27
Calibration View Mode	27
Calibration Set Mode	28
Changing the Instrument Settings	29
Calibration Menu Tree	30
Instrument Settings	32
Units of Measurement	32
Parameters	33
Inputs	34
Outputs	39
Alarms	41
Communications	43
Time Settings and Data Logging	45
General Setup Parameters	47
Test Menu	49
System Messages	50
Error Messages	51
Warning Messages	52
Prompt Messages	52

6 Communications

Overview	53
Hardware Interconnection	53
Protocols	55
Simple ASCII Protocol	55
Requests Format	56
Instrument Responses	57
Corrupted or Invalid Requests	60
Modbus RTU Protocol	61

List of Data Registers	62
iButton ID Tag Protocol	67
Printer Protocol	68
Types of Printouts	68
Printer Data Control	71
Appendix A Glossary	
Glossary	73
Appendix B Model Numbers	
Product Codes	75
Custom Version Codes	76
Application Information Code	76
Appendix C Units of Measurement	
Available Units of Measurement	78
Index	79

List of Figures

1	Typical Application Diagram	4
2	500 Series Instrument Panel Mounting	7
3	Rear Panel Connections	8
4	Externally Powered Voltage Transmitter	10
5	Internally Powered Voltage Transmitter	10
6	Externally Powered Current Loop	11
7	Internally Powered Current Loops	11
8	RTD Connection	11
9	Logic Inputs Connection Diagram	12
10	Output 4-20mA Connection Diagram	13
11	Output Pulse Connection Diagram	13
12	Relay Connection Diagram	14
13	RS-485 Interface Connections	16
14	Calibration Menu Tree Sheet 1	30
15	Calibration Menu Tree Sheet 2	31
16	RS-232 Cable Connections to a Computer	54
17	RS-485 Connections	54

Chapter 1

Introduction

Features

- Tailored for volumetric frequency flow input
- ID Tag validation, preprogrammed ratio %
- Pump demand contact
- Selection of various modes of operation
- Process line control via DCV (digital control valve)
- Remote PERMISSIVE input to control delivery's state
- Displays general purpose analog inputs
- Includes user programmable value into delivery log
- Allows for simplified main menu
- Allows for non-linear correction
- Storage of 1000 transactions with time and date stamp
- Selection of second language and user tags
- Infra-red communications port on front panel
- Pulse width and scaling of pulse output
- 4-20mA retransmission
- Selectable protocols on serial ports including Modbus RTU and Printer output
- Front panel adjustment of 8-24V DC output voltage
- Backlit display with LCD backup

Overview

The 515 CB02 application is a secure blending controller measuring the volume flow in a main and process lines using frequency flow inputs.

The main and process flows are used to determine the net volume flow. The operator can view the ratio of totals as well as the ratio of flow rates.

The control of the process flow is via a digital control valve. The control responsiveness and flowrate deadband can be adjusted to reduce wear on valves.

The instrument can be set to prompt for a valid ID-Tag before a delivery can be commenced. The valid ID-Tag also sets the pre-programmed target ratio % and is stored as a part of the logged transaction record.

Calculations

The total and flowrate are derived from accurately measured frequency and the number of received pulses.

$$\text{volume} = \text{pulses} / k\text{-factor}$$

$$\text{volume flow} = \text{frequency} / k\text{-factor}$$

The controller caters for blending points before and after the main flowmeter. The process flow is a ratio of the net (combined) flow (0 to 100% range).

$$\text{Ratio}\% = \frac{P_{\text{flow}}}{\text{Net}_{\text{flow}}} \times 100$$

Analog Input Scaling

The analog inputs in this instrument are scaled by the following general formula:

$$f(A) = P_{\text{min}} + (P_{\text{max}} - P_{\text{min}}) \cdot A^*$$

where:

P_{min} = minimum point (equivalent to offset)

P_{max} = maximum point ($P_{\text{max}} - P_{\text{min}}$ is equivalent to span)

A^* = normalised signal (0 to 1) with correction applied for a flow input

Correction Type

- **LINEAR:** $A^* = A$ when the instrument is not required to apply correction
- **NON-LINEAR:** $A^* = A_c$ when the instrument applies correction from the points in the correction table

Displayed Information

The front panel display shows the current values of the input variables and the results of the calculations.

The instrument can be supplied with a real-time clock for storage of up to 1000 transactions with time and date stamps.

Main Menu Variables

Main Menu Variables	Default Units	Variable Type
*Net Volume	L	Total
Net Flowrate	L/min	Rate
Main Line Volume	L	Total
Main Line Flowrate	L/min	Rate
*Process Line Volume	L	Total
Process Line Flowrate	L/min	Rate
Volumetric Ratio	%	Rate
Flowrate Ratio	%	Rate
Flowrate Deviation	L/min	Rate
*Analog Input 1	metres	Rate
*Analog Input 2	metres	Rate
*Target Ratio	---	---
User Value	---	---
Batch ID Tag	---	---

* - These variables form the simplified main menu.

Refer to [Available Units of Measurement](#) on page 78 for the list of available units.

Communications

There are three communication ports available as follows:

- RS-232 port
- RS-485 port (optional)
- Infra-red port

The ports are available for remote data reading, printouts and for initial application loading of the instrument.

Isolated Outputs

The opto-isolated outputs can re-transmit any main menu variable. Totals are output as pulses and rates are output as 4-20mA signals. Alternatively, the outputs can be configured to provide application specific digital signals like flow error, pump demand, etc.

Relay Outputs

The relay outputs 3 and 4 control the blending flow via a digital control valve. The relay output 2 provides a pump demand contact and the relay 1 can be used as a fully programmable alarm for any rate type variable.

Software Configuration

The instrument can be further tailored to suit specific application needs including units of measurement, custom tags, second language or access levels. A distributor can configure these requirements before delivery.

Instrument parameters including units of measurement can be programmed in the field, according to the user access levels assigned to parameters by the distributor.

All set-up parameters, totals and logged data are stored in non-volatile memory with at least 30 years retention.

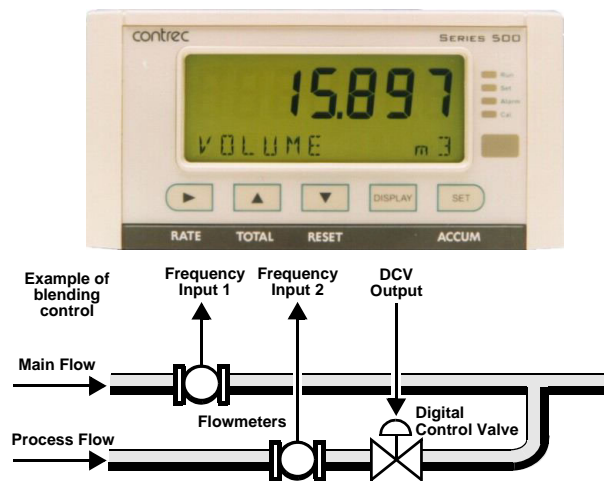

Figure 1 Typical Application Diagram

Approvals

This instrument conforms to the EMC-Directive of the Council of European Communities 89/336/EEC and the following standards:

- Generic Emission Standard EN 50081-1 Residential, Commercial & Light Industry Environment.
- Generic Emission Standard EN 50081-2 Industrial Environment.
- Generic Immunity Standard EN 50082-1 Residential, Commercial & Light Industry Environment.
- Generic Immunity Standard EN 50082-2 Industrial Environment.

In order to comply with these standards, the wiring instructions in [Chapter 3 - Installation](#) must be followed.

Chapter 2

Specifications

Specification Table

Operating Environment	
Temperature	-20°C to +60°C (conformal coating) +5°C to +40°C (no coating)
Humidity	0 to 95% non condensing (conformal coating) 5% to 85% non condensing (no coating)
Power Supply	95...135 V AC or 190...260 V AC or 12...28 V DC
Consumption	6W (typical)
Protection	Sealed to IP65 (Nema 4X) when panel mounted
Dimensions	147mm (5.8") width 74mm (2.9") height 167mm (6.6") depth

Display	
Type	Backlit LCD with 7-digit numeric display and 11-character alphanumeric display
Digits	15.5mm (0.6") high
Characters	6mm (0.24") high
LCD Backup	Last data visible for 15min after power down
Update Rate	0.3 second

Non-volatile Memory	
Retention	> 30 years
Data Stored	Setup, Totals and Logs

Approvals	
Interference	CE compliance
Enclosure	ATEX, FM, CSA and SAA approved enclosures available for hazardous areas

Real Time Clock (Optional)	
Battery Type	3 volts Lithium button cell (CR2032)
Battery Life	5 years (typical)

Frequency Input (General)	
Range	0 to 10kHz
Overvoltage	30V maximum
Update Time	0.3 sec
Cutoff frequency	Programmable
Configuration	Pulse, coil or NPS input
Non-linearity	Up to 10 correction points

Pulse	
Signal Type	CMOS, TTL, open collector, reed switch
Threshold	1.3 volts

Coil	
Signal Type	Turbine and sine wave
Sensitivity	15mV p-p minimum

NPS	
Signal Type	NPS sensor to Namur standard

Analog Input (General)	
Overcurrent	100mA absolute maximum rating
Update Time	< 1.0 sec
Configuration	4-20mA, 0-5V and 1-5V input
Non-linearity	Up to 20 correction points (some inputs)

RTD Input	
Sensor Type	PT100 & PT500 to IEC 751
Connection	Four Wire
Range	-200°C to 350°C
Accuracy	0.1°C typical

4-20mA Input	
Impedance	100 Ohms (to common signal ground)
Accuracy	0.05% full scale (20°C) 0.1% (full temperature range, typical)

0-5 or 1-5 Volts Input	
Impedance	10MOhms (to common signal ground)
Accuracy	0.05% full scale (20°C) 0.1% (full temperature range, typical)

Logic Inputs

Signal Type	CMOS, TTL, open collector, reed switch
Overtoltage	30V maximum

Relay Output

No. of Outputs	2 mechanical relays plus 2 relays
Voltage	250 volts AC, 30 volts DC maximum (solid state relays use AC only)
Current	3A maximum

Communication Ports

Ports	RS-232 port RS-485 port (optional) Infra-red port
Baud Rate	2400 to 19200 baud
Parity	Odd, even or none
Stop Bits	1 or 2
Data Bits	8
Protocols	ASCII, Modbus RTU, Printer, ID-Tag

Transducer Supply

Voltage	8 to 24 volts DC, programmable
Current	70mA @ 24V, 120mA @ 12V maximum
Protection	Power limited output

Isolated Output

No. of Outputs	2 configurable outputs
Configuration	Pulse/Digital or 4-20mA output

Pulse/Digital Output

Signal Type	Open collector
Switching	200mA, 30 volts DC maximum
Saturation	0.8 volts maximum

4-20mA Output

Supply	9 to 30 volts DC external
Resolution	0.05% full scale
Accuracy	0.05% full scale (20°C) 0.1% (full temperature range, typical)

Important: Specifications are subject to change without notice.

Chapter 3

Installation

Panel Mounting

The instrument should be located in an area with a clean, dry atmosphere that is also relatively free of shock and vibration.

The standard mounting procedure is panel mounting in a cutout that is 139mm wide by 67mm high. Two side clips secure the unit into the panel.

Figure 2 shows the panel mounting requirements for the 500 Series Instrument.

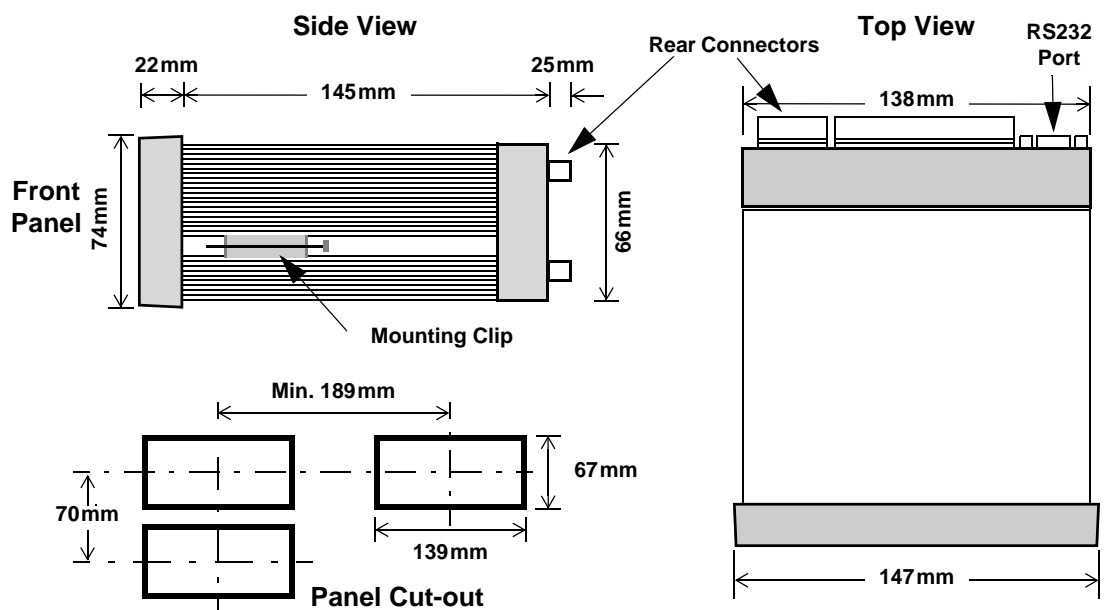

Figure 2 500 Series Instrument Panel Mounting

Electrical Connection

Rear Panel Connections

Figure 3 shows the connections on the rear panel of the instrument.

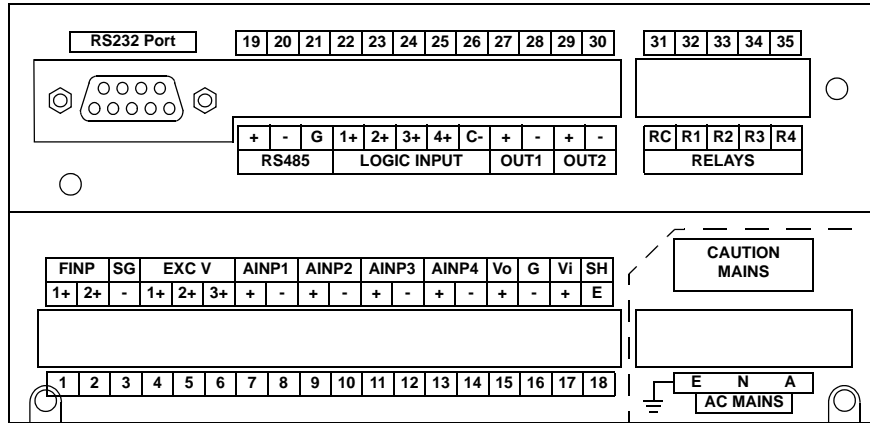

Figure 3 Rear Panel Connections

Terminal Designations

Terminal Label	Designation	Comment	Terminal Label	Designation	Comment
1	FINP 1+	Frequency Input 1+	19	RS485 +	RS485 (+)
2	FINP 2+	Frequency Input 2+	20	RS485 -	RS485 (-)
3	SG -	Signal ground	21	G	RS485 ground
4	EXC V 1+	Excitation Term 1+	22	LOGIC INPUTS 1+	Switch 1
5	EXC V 2+	Excitation Term 2+	23	LOGIC INPUTS 2+	Switch 2
6	EXC V 3+	Excitation Term 3+	24	LOGIC INPUTS 3+	Switch 3
7	AINP1 +	Analog input ch 1 (+)	25	LOGIC INPUTS 4+	Switch 4
8	AINP1 -	Analog input ch 1 (-)	26	C-	Signal ground
9	AINP2 +	Analog input ch 2 (+)	27	OUT1 +	Output ch 1 (+)
10	AINP2 -	Analog input ch 2 (-)	28	OUT1 -	Output ch 1 (-)
11	AINP3 +	Analog input ch 3 (+)	29	OUT2 +	Output ch 2 (+)
12	AINP3 -	Analog input ch 3 (-)	30	OUT2 -	Output ch 2 (-)
13	AINP4 +	Analog input ch 4 (+)	31	RELAYS RC	Relay common
14	AINP4 -	Analog input ch 4 (-)	32	RELAYS R1	Relay 1
15	Vo +	8-24 volts DC output	33	RELAYS R2	Relay 2
16	G -	DC Ground	34	RELAYS R3	Relay 3 (DCV Open)
17	Vi +	DC power input	35	RELAYS R4	Relay 4 (DCV Hold)
18	SH E	Shield terminal		RS232 port	9-pin serial port
E	AC MAINS E	Mains ground			
N	AC MAINS N	Mains neutral			
A	AC MAINS A	Mains active			

Inputs

Frequency Input Connection

Connect pulse or frequency input signals from devices such as: TTL, CMOS, open collector, reed relay switch, coil and Namur proximity switch, as shown below. For better signal integrity, it is recommended to use shielded cable. Refer to [Terminal Designations](#) on page 8 for specific terminal numbers for this application.

Squarewave, CMOS or TTL

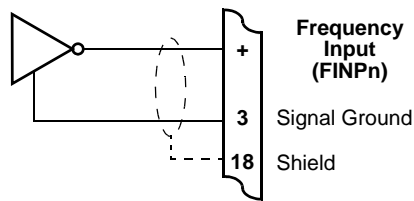

Open Collector

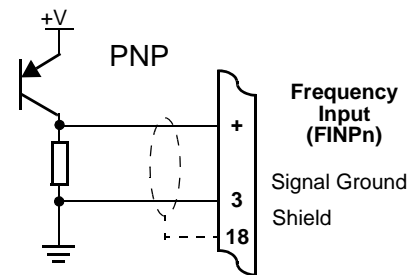
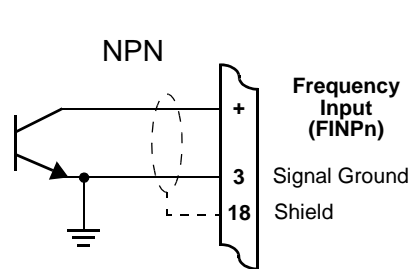

Reed Relay Switch

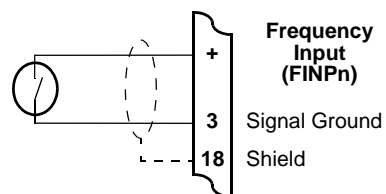

Coils - with 15 millivolts peak to peak AC minimum

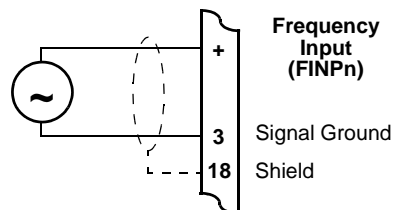

Namur Proximity Switch

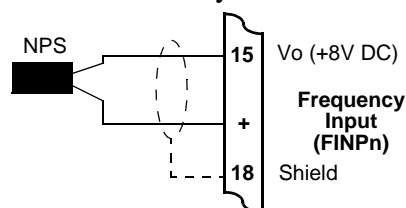

Analog Input Connections

All analog inputs can accept DC signals ranging from 0-5V, 1-5V and current signals from 4 to 20mA.

Analog Inputs 1 and 2 (AINP1 / AINP2) can also accept an RTD input (PT100 or PT500) as well as the standard 0-5V, 1-5V and 4 to 20mA input.

CAUTION

Applying levels of input current above the absolute maximum rating (100mA) may cause permanent damage to the input circuitry.

0-5 and 1-5 Volt Inputs

For externally powered voltage transmitters, connect each transmitter to a pair of input terminals as shown in Figure 4. Refer to [Terminal Designations](#) on page 8 for specific terminal numbers for this application.

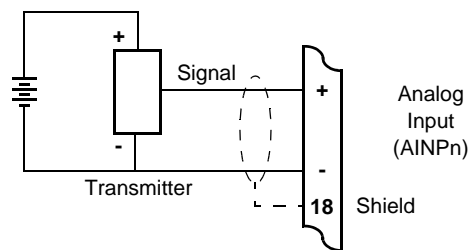

Figure 4 Externally Powered Voltage Transmitter

Connect internally powered voltage transmitters as shown in Figure 5.

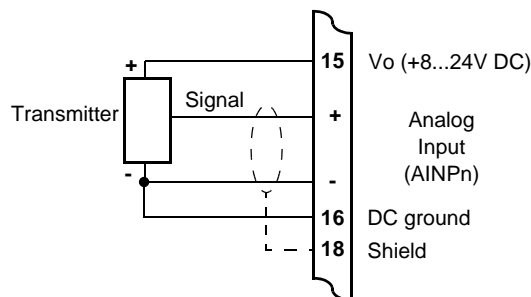

Figure 5 Internally Powered Voltage Transmitter

4-20mA Inputs

For externally powered current loops, connect each transmitter to a pair of input terminals as shown in Figure 6. [Terminal Designations](#) on page 8 for specific terminal numbers for this application.

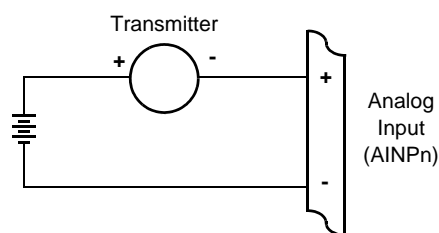

Figure 6 Externally Powered Current Loop

The internal overload-protected power supply has sufficient power for three current loops at 24V DC (more current loops can be supplied by using a reduced voltage setting). Connect internally powered current loops as shown in Figure 7.

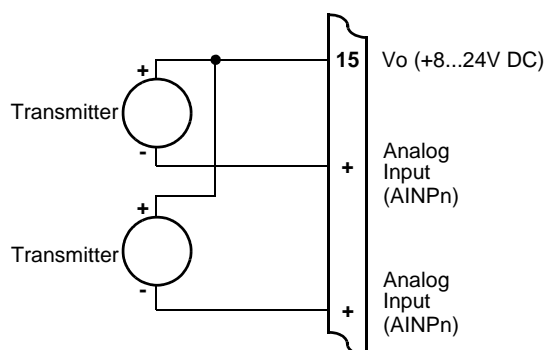

Figure 7 Internally Powered Current Loops

RTD Input

Analog Inputs 1 and 2 (AINP1/AINP2) are available for RTD connection. The instrument uses 4-wire RTDs to provide optimum accuracy and stability. It is recommended to use shielded twisted pairs and to have cable length no longer than 50 metres.

Connect RTD inputs as shown in Figure 8.

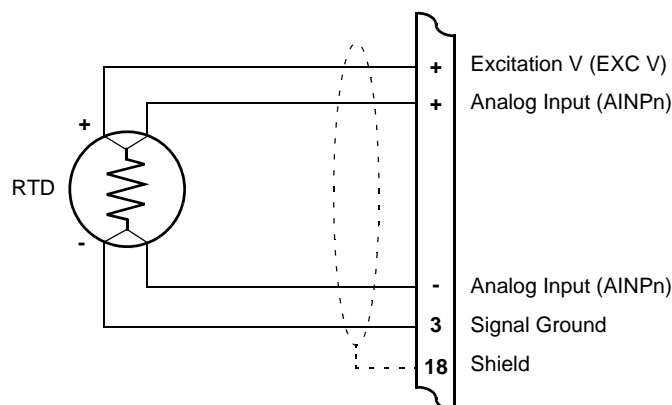

Figure 8 RTD Connection

Excitation terminal 2 (pin 5) must be used in conjunction with AINP1.
 Excitation terminal 3 (pin 6) must be used in conjunction with AINP2.

It is possible to use two-wire or three-wire RTDs. However, four wires must be taken to the RTD, with the signal and current wires joined as close to the RTD as possible.

Note: The RTD has no polarity and can be connected in either direction. However, the excitation and the positive analog input must be connected to one side of the RTD. Similarly, the Signal Ground and the negative analog input must be connected to the other side of the RTD.

Logic Input Connection

These inputs are designed to be connected to CMOS, TTL, open collector signals or a voltage free contact switch. A minimum activation time of 300ms is required to guarantee reading of an input.

It is possible to read the status of all the logic inputs via a Modbus register even if they are not used for a control purpose in the application.

A remote push-button key can be connected to the Logic Inputs as shown below. [Logic Input Control](#) on page 24 describes the function of the inputs.

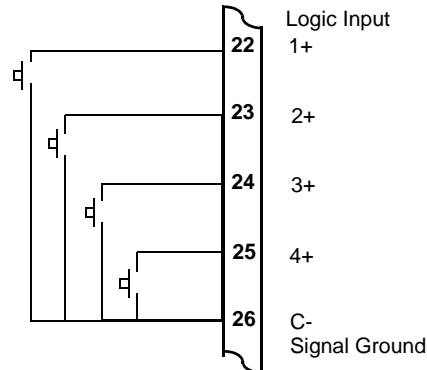

Figure 9 Logic Inputs Connection Diagram

Outputs

The advanced option for the instrument provides two opto-isolated output ports. Either or both can be used for 4-20mA or pulse outputs.

CAUTION

Due to the dual-purpose nature of the outputs, take care not to set the output as an open collector pulse type signal when connected to a 4-20mA loop circuit.

4-20mA Output Connection

Figure 10 shows the connections for a 4-20mA output. Output channel 1 uses terminals 27 (+) and 28 (-), output channel 2 uses terminals 29 (+) and 30 (-).

$$\text{Maximum Load Resistance} = (\text{Supply} - 9) / 0.02 \text{ ohms}$$

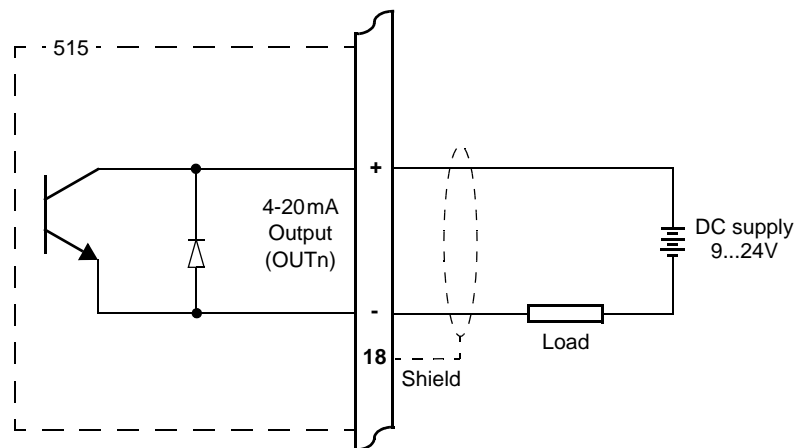

Figure 10 Output 4-20mA Connection Diagram

Pulse Output Connection

Figure 11 shows a connection example for a pulse output. Output channel 1 uses terminals 27 (+) and 28 (-). Output channel 2 uses terminals 29 (+) and 30 (-).

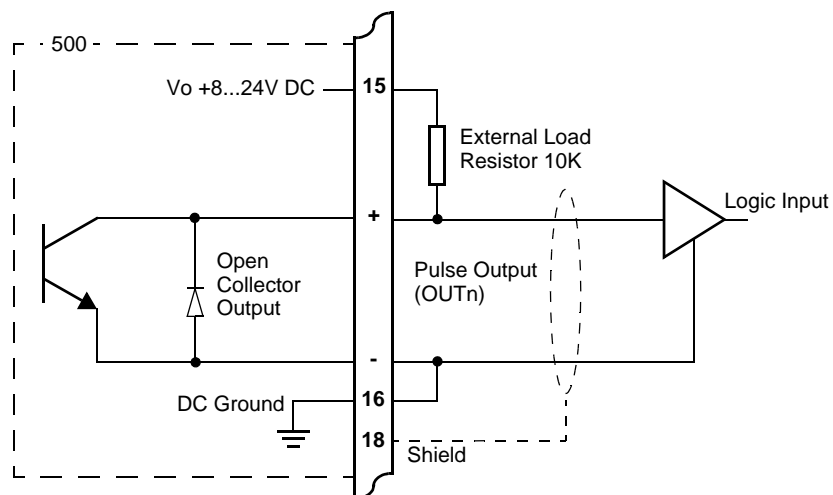

Figure 11 Output Pulse Connection Diagram

Control Relays (Alarms)

The solid state relay outputs 3 and 4 provide DCV control. The relay output 2 provides a pump demand contact and the relay 1 can be used for alarms on any rate type variable.

The operation of alarm relay(s) can be set to various modes as described in [Alarms](#) on page 41.

There is also an equipment failure alarm option. This alarm can have normally closed (open) contacts which open (close) when the instrument displays any error message as listed in [Error Messages](#) on page 51, or if there is a loss of power to the instrument.

The output characteristics of the relays are:

Maximum Voltage 250 volts AC

Maximum Current 3 A

Note: Solid state relays use AC voltage only.

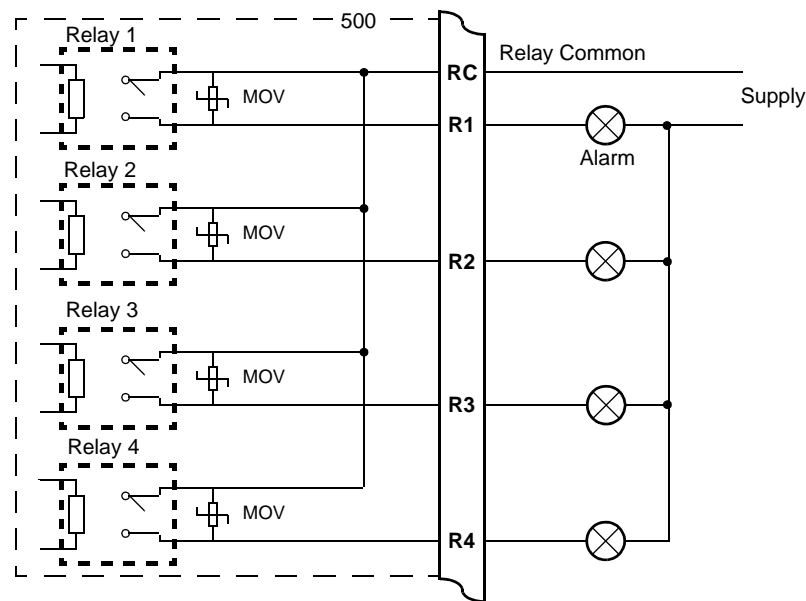

Figure 12 Relay Connection Diagram

RC Network for Interference Suppression

When driving highly inductive loads with the relay outputs, it is recommended to use RC suppression networks (often called “Snubbers”) for the following reasons:

- To limit the amount of electrical noise caused by arcing across the contacts, which may, in extreme cases, cause the microprocessor to act erratically.
- To protect the relay contacts against premature wear through pitting.

RC suppression networks consist of a capacitor and series resistor and are commonly available in the electrical industry. The values of R and C are dependent entirely on the load. However, if the user is unsure of the type of snubber to use, values of 0.25 μF and 100 Ω will usually suffice. Note that only mains-approved RC suppression networks should be used.

The basic principle of the operation is that the capacitor prevents a series of sparks arcing across the contact as the contact breaks. The series resistor limits the current through the contact when the contact first makes.

Communications

The communication protocols are described in [Communications](#) on page 53.

RS-232 Port

The RS-232 port has a 9-pin DB female connector and has the following pinout:

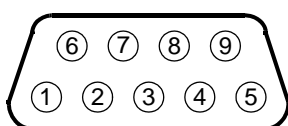

Pin 1	Not used
Pin 2	Transmit (TxD)
Pin 3	Receive (RxD)
Pin 4	Not used
Pin 5	Ground
Pin 6	Not used
Pin 7	Handshake line (CTS)
Pin 8	RTS Out
Pin 9	Not used

Note: The instrument does not require a null-modem cable for connection to a personal computer. Refer to [Hardware Interconnection](#) on page 53 for cable termination requirements.

Infra-red Port

The infra-red port is located at the front panel, directly below the row of status indicators. The main function of this port is for retrieving current or logged data with a PC that has an infra-red port.

RS-485 Port (Optional)

Up to 32 units can be connected to a common RS-485 bus. Each unit has a unique address that the host computer uses to identify each instrument.

Figure 13 shows the connection of several instruments to a computer using the RS-485 port.

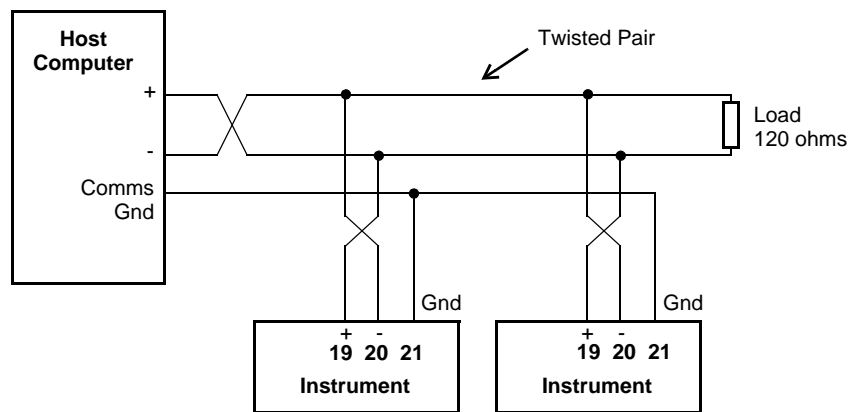

Figure 13 RS-485 Interface Connections

Earthing and Shielding

It is a good practice to use shielded cable for all signal connections to the instrument. Care must be taken to separate signal cables from power cables to minimize interference.

Overall earth should be connected at the instrument end only. This connection should be as short as possible and connected to the earthing point on the rear terminal at pin 18.

Chapter 4

Operation

Normal Operation Mode

In normal operation mode, you press the buttons on the front panel to display the values recorded and calculated by the instrument. There are five categories of information that the instrument can display:

- Totals
- Rates
- Process variables
- Control setpoints
- Instrument settings

For each total, there is an associated rate as follows:

Total	Rate
Net Volume	Net Flowrate
Main Line Volume	Main Line Flowrate
Process Line Volume	Process Line Flowrate

Default Variable & Total

In some applications, a particular variable or particular set of total and rate is of more interest than others, and for this reason a default variable and a default total (and its associated rate) can be assigned during instrument calibration. These defaults are used in the following ways:

- The default total (and rate) determines what comes first in the sequence of totals and rates that are displayed with the front panel keys.
- The default variable determines what the display returns to if the display timeout option is enabled and no buttons are pressed for the selected period (usually 30 seconds). It also determines what is displayed on power up.

Status Lamps

The status lamps illuminate to show the following conditions:



- Run** Solid LED: delivery is in progress
Flashing LED: delivery has reached the flushing stage
- Set** The instrument is in Calibrate Set mode.
- Alarm** The instrument has an error, as indicated on the display panel.
- Cal** The instrument is in Calibrate View mode.

Front Panel Keys

For most actions with the front panel keys, you can hold a key to scroll through the values or options, instead of repeatedly pressing the key.

RATE Press the **RATE** key to display the rate that is associated with the currently displayed total. If an item other than a rate or total is displayed, press the **RATE** key to display the “default rate”. When a rate is displayed, press or hold the **RATE** key to display the other rate variables in turn.

TOTAL Press the **TOTAL** key to display the total that is associated with the currently displayed rate. If an item other than a rate or total is displayed, press the **TOTAL** key to display the “default total”. When a total is displayed, press or hold the **TOTAL** key to display the other total variables in turn.

RESET Use the **RESET** key to clear the totals when delivery is not in progress or to initiate a printout if the printer option has been selected. The printout is activated with a single press while the reset of the totals requires a press and hold for two seconds. The instrument generates three beeps when it resets the totals and two beeps when a printout is started.

DISPLAY Press the **DISPLAY** key to step or scroll through the main menu items.

ACCUM Hold the **ACCUM** key to display the accumulated value for the currently displayed total or to display the peak value for the currently displayed flowrate. See below for further details of peak flowrates.

Main Menu Items

The main menu in this instrument consists of the following items. The **DISPLAY** key is used to step or scroll through the list.

DISPLAY ↓	Description	Options
N-VOL	*Net volume	Hold the ACCUM key to display accumulated total
N-FLOW	Net flowrate	Hold the ACCUM key to display peak value
M-VOL	Main line volume	Hold the ACCUM key to display accumulated total

<div style="border: 1px solid black; padding: 2px; display: inline-block;">DISPLAY</div> ↓	Description	Options
M-FLOW	Main line flowrate	Hold the ACCUM key to display peak value
P-VOL	*Process line volume	Hold the ACCUM key to display accumulated total
P-FLOW	Process line flowrate	Hold the ACCUM key to display peak value
R-VOL	Process volumetric ratio	
R-FLOW	Process flowrate ratio	
DEVIAT	Process flowrate deviation	
RINP1	*Analog input 1	
RINP2	*Analog input 2	
TARGET	*Target ratio %	Hold the SET key to edit the controlling setpoint if enabled
USER VALUE	User entered value	Hold the SET key to edit the current User Value if enabled (see below for details)
ID-TAG	Only shown if ID-TAG protocol is selected	Validate ID tag before delivery is started as described in ID Tag Validation on page 24
REPORT PRINT	Only shown if print option is selected	Hold the SET key to print log report as defined in the TM/LOG section of calibration
LOGGED DATA	Only shown if real-time clock option is installed	Hold the SET key to display data logs as described in Data Logs on page 20
MODEL INFO		Hold the SET key to display the Model information as described in Model Information on page 21
CAL MENU		Hold the SET key to enter Calibration View mode as described in Calibration View Mode on page 27

* - These variables form the simplified main menu.

Simplified Main Menu

It is possible to operate the instrument with the reduced number of main menu variables. To toggle between the standard and simplified menus press and hold the  and **DISPLAY** keys for 2 seconds. The instrument generates two beeps when it toggles between the menus.

Peak Flowrates

The peak value for the currently displayed flowrate can be viewed by holding the **ACCUM** key. The peak value is the average over a 15 minute period since the last reset of totals or powering on of the instrument. Dashes are shown for this value after a reset or power on until the first averaging period has passed.

User Value

SET Hold the **SET** key to edit the current User Value while viewing the User Value in the main menu. The display of the User Value will change from view mode to edit mode after 2 seconds if access has been enabled in calibration. Once in edit mode the **Set** indicator will illuminate and the User Value can be changed. The User Value is stored in the delivery log and can be used as an Operator Identifier.

Setpoints

SET Hold the **SET** key to display (or edit) the controlling setpoint while viewing one of the process variables. The display of the setpoint will change from view mode to edit mode after 2 seconds if access has been enabled in calibration. Once in edit mode the **Set** indicator will illuminate and the setpoint values are changed in exactly the same way as in calibration set mode.

Data Logs

The instrument will log up to 1000 deliveries (batches) if the real-time clock option is installed. The logs are taken at the end of each batch. Each entry has a log number, a delivery number and a time and date stamp. When the number of log entries exceeds 999 the oldest log entry is overwritten by the newest one.



View Data Logs

Use the following procedure to view the data that has been logged by the instrument:

1. Press the **DISPLAY** key to scroll through the menu to the **LOGGED DATA** prompt.
2. Hold the **SET** key.

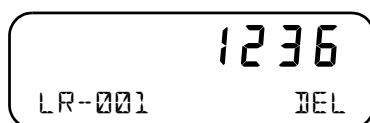
The system displays the most recent log record first. The log record number and corresponding delivery number are shown, for example LR-001 and DEL 1236.



3. Use the  or  keys to scroll to the delivery number or log record of interest.
4. Press the **DISPLAY** key to show the information stored in the selected log record. Each log record consists of:
 - time and date stamp,
 - error code
 - totals for the delivery.
5. While holding the **DISPLAY** key use the  key to step through the stored information.
6. While holding the **DISPLAY** key use the **RESET** key to print the data for the displayed log if the printer option has been selected.

The following example shows the format of the time and date stamp at 15:25 (3:25 pm) on 16 January 2004. The day and month alternate with the year in the bottom right hand corner.

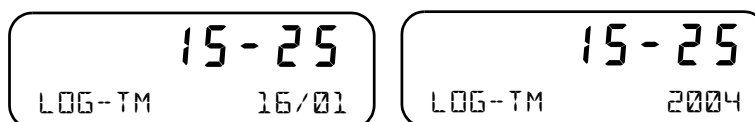

Model Information

The model information items display the hardware, software and application versions of the instrument. This information is mainly for service personnel.

DISPLAY ↓	Description
-- 1-- F-- 515 MODEL	The hardware model code. Refer to Product Codes on page 75 for more information.
FFAA-- C002 INPUT	The Application number and the assignment of the inputs. Refer to Application Information Code on page 76 for more information.
0101.002 C002 VERS	The version of software loaded into the instrument.

<div style="border: 1px solid black; padding: 2px; display: inline-block;">DISPLAY</div> ↓	Description
026357 CUSTOM VERS	The Customer version code for this installation. Refer to Custom Version Codes on page 76 for more information.
123456 ABC123 S/N	The instrument serial number and unit tag. The serial number is on the top line and unit tag is on the bottom left. Both items are entered when the instrument application software is initially loaded. The default unit tag is UNIT-1.
16-15 EDITED 27/08 2002	The time and date when the calibration of the instrument was last edited. The format of the time and date is the same as for the data logs. This example shows 16:15 (4:15pm) on the 27th August 2002. This function is available only if the instrument has the real time clock option.

Press **SET** at any time to exit from the Model information.

Blending Operation

The blending (process) line flow is controlled via a digital control valve (DCV) connected to the two solid state relay outputs. During delivery, the blending flow is controlled as the ratio of the net (combined) flow.

The instrument can operate in the following modes:

- PRESET
- ON-OFF
- RELEASE (only available in calibration set mode)

In the PRESET mode, the remote PERMISSIVE input (Logic Input 1) or Modbus RTU command is used to control the delivery's state (non-idle Modbus commands override the remote input). The delivery is registered as started when PERMISSIVE input is activated (or Modbus RUN command is received). The delivery is registered as finished when PERMISSIVE input is deactivated (or Modbus STOP command is received). The delivery logging occurs when the net flow actually stops.

In the ON-OFF (manual) mode the presence of the actual flow is used to determine the delivery's state. The delivery is registered as started when the net flow starts, and the delivery is finished and logged when the net flow stops. In this mode the Logic Input 1 inhibits the blending (process) line flow if de-activated (open circuit).

The RELEASE mode is only accessed from within the calibration mode and allows the operator to view the concise list of key parameters and gain immediate feedback for easier DCV control loop tuning. The control and tuning of the process line in this mode is independent of the main flow (deliveries are not registered in this mode). The optimal control can be achieved by adjusting the deadband and control factor parameters at the specified flowrate. The control factor allows the system response to be fine tuned by scaling the control signal (lower values will slow down the DCV operation).

Typical Blending Configurations

Blend Point After the Main Line Meter

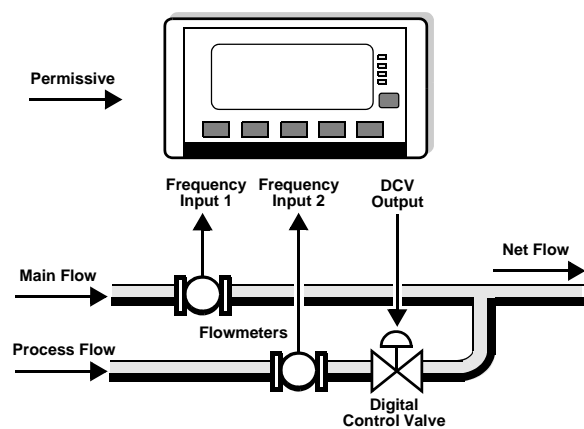

The desired blending ratio set point (RATIO %) is set via the front panel or serial communications.

The two solid state relays are used to maintain the desired process flowrate by controlling the digital control valve.

The desired process flow is determined as a ratio of the net (combined) flow (0 to 100% range). i.e.

$$Ratio\% = \frac{P_{flow}}{M_{flow} + P_{flow}} \times 100$$

Blend Point Before the Main Line Meter

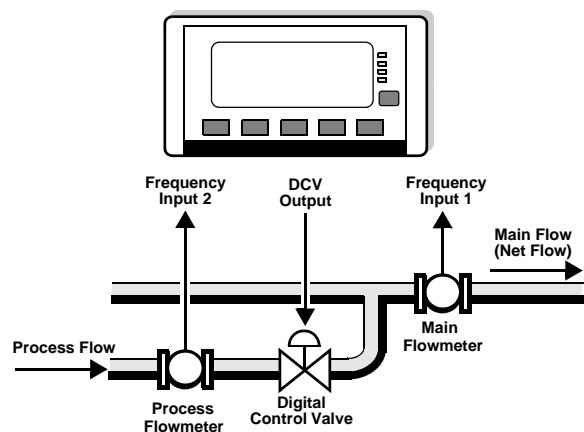

The desired blending ratio set point (RATIO %) is set via the front panel or serial communications.

The two solid state relays are used to maintain the desired process flowrate by controlling the digital control valve.

The desired process flow is determined as a ratio of the main (net) flow (0 to 100% range). i.e.

$$Ratio\% = \frac{P_{flow}}{M_{flow}} \times 100$$

Resetting Totals

The instrument totals are reset by different means:

- At the end of a delivery, you can press the **RESET** key to reset the totals.
- Totals will automatically reset when the next delivery starts.

Logic Input Control

This instrument allows for remote operation via the logic inputs on the rear terminals. The logic inputs have the following functions:

- Logic Input 1 - Permissive

For connection details, refer to [Logic Input Connection](#) on page 12.

ID Tag Validation

If this feature has been enabled, a valid Identification Tag must be detected before the operator is able to start a batch. The ID Tag is read via an external “LINK-45 i-button” module that has been connected and assigned to one of the physical communication ports. The instrument in the idle state will scroll a prompt to ‘Validate ID Tag’.

If an invalid ID Tag is presented the instrument will beep and display “ID FAIL” and will return to its idle state. If a valid ID Tag is presented the instrument will beep and display “ID GOOD” before scrolling a prompt to ‘Start Delivery’.

To be ‘valid’ an ID Tag must have been pre-stored into the instruments memory either through the [General Setup Parameters](#) on page 47 or via Modbus communication using [Instrument Configuration Parameters](#) on page 66.

The ID Tag is shown in the main menu items and is stored as a part of the logged delivery data. This recorded ID code can be used to link deliveries to external customer or user data bases.

Digital Control Valve Connection

This instrument provides two solid state relay outputs to operate a DCV for blending line control. The relay 4 should be connected to the HOLD valve solenoid (usually normally open) and the relay 3 should be connected to the OPENING valve solenoid (usually normally closed).

IMPORTANT: Only AC power should be used for these outputs.

It is also possible to configure optoisolated DC outputs to provide Increase/Decrease control signals that may be more suitable for other types of blend control systems, including stepper motor driven valves, etc.

Blending Errors

The instrument has the ability to raise an alarm when it detects a loss of flow, an overflow, or a leakage in the system.

- **No Flow Error** - The no flow condition is detected when the flow timeout expires during a delivery. There must not be a period of no flow greater than the timeout value during the delivery.
- **Overflow Error** - The overflow condition is detected when the flow continues longer than the timeout period after the controller has attempted to stop the flow.
- **Leakage Error** - The leakage condition is detected when an amount greater than the acceptable total is received with no delivery in progress.

The point at which these errors are detected is dependent on the values programmed into the calibration parameters FLOW TIMEOUT and ACCEPTABLE TOTAL. The open collector outputs can be assigned to activate when one of the flow errors occurs. Refer to [Instrument Settings](#) on page 32 for more details.

Chapter 5

Instrument Calibration

Introduction

You can view or change the settings of the instrument according to the access level for each parameter as set by the manufacturer. There are four levels of access to the parameters as follows:

- **Not visible** - you cannot display or edit the parameter.
- **Display Only** - you can display the parameter, but you cannot change the setting.
- **Programmable** - you can change the setting of the parameter in Calibration Set mode.
- **Password protected** - you can change the setting of the parameter in Calibration Set mode only if you enter the correct password.

Note: When you enter Calibration Set mode, the instrument requests you to enter a password. Any value will allow to change the settings of the “programmable” parameters, but the correct password must be entered to change the password-protected parameters.

Calibration View Mode

Use the following procedure to view the calibration settings of the instrument:

1. Press **DISPLAY** to scroll to the **CFM MENU** prompt.
2. Hold the **SET** key.



The instrument beeps once, illuminates the **Cal** indicator and shows **CFM** on the display panel.

- Press **▶** to scroll through the flashing menu headings.
 - Press **SET** to scroll through submenu items.
 - Press **DISPLAY** to return to the main calibration menu.
3. To exit from the Calibration View mode, press **▶** to scroll to the **END** option and press **SET**.

The instrument returns to Normal Operation mode.

Calibration Set Mode

In Calibration Set mode, you can change the settings of the “programmable” parameters. You must enter the system password to change the setting of the “password-protected” parameters.

Use the following procedure to enter Calibration Set mode:

1. Press **DISPLAY** to scroll to the **FL MENU** prompt.
2. Hold the **SET** key.



The instrument beeps once, illuminates the **Cal** indicator and shows **FL** on the display panel.

3. Press **▶** to select any flashing menu heading except **END**.
4. Hold **SET** for two seconds.

The instrument requests a password.

5. Press **▲** or **▼** to change the value of the current digit. To select the next digit, press **▶**.
6. Press **SET** to accept the password.

- The instrument makes two beeps for a correct password entry and enables you to change the “programmable” and “password-protected” parameters.

- The instrument makes one beep for an incorrect password entry and enables you to change only the “programmable” parameters.



The instrument illuminates both the **Cal** and **Set** indicators.

7. Edit the instrument parameters as required. The programmable values are indicated by the flashing display.
 - To change a numerical value, press **▲** to increase a value, or press **▼** to decrease a value. Press a key momentarily to change the value one number at a time. Hold a key to scroll through the numbers. To proceed to next digit, press **▶**.
 - To change an option setting, press **▲** or **▼** to scroll through the options.
8. Press **SET** to accept the currently displayed value and proceed to the next parameter. You can press **DISPLAY** to return to the main calibration menu.
9. To exit from Calibrate Set mode, press **▶** to scroll through the main calibration menu to **END**, then press **SET**. Otherwise, from any menu, you can press and hold **SET** for two seconds.

The instrument makes two beeps and cancels the **Cal** and **Set** indicators.





Changing the Instrument Settings

In Calibration Set mode, the display flashes the item that can be changed. For option settings, the display flashes the complete option. For a numeric parameter, the display flashes one digit at a time, you can change the value of the flashing digit as required, then move the flashing cursor to change another digit.

Note: When you change the setting of a parameter, the instrument records the result as soon as you move to another parameter, or exit from the Calibration Set mode.

Changing Option Settings

When you display an option that can be changed, the entire option flashes on the display, such as the choices of ODD, EVEN or NONE for the communications parity bit checking. Press  or  to change the option. You can “scroll” through the options in either direction to make a selection as shown below.

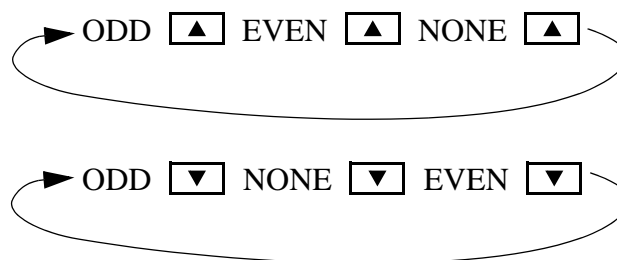

Changing Numeric Settings



The display flashes the digit that can be changed.



Press  to select the digit that you wish to change.

Press  or  to increase or decrease the value of the selected digit.

Changing the Decimal Point

To change the position of the decimal point, press  to move the flashing selection until the decimal point flashes. Press  or  to move the decimal point to the right or left as required.

Units of Measurement

The calibration of some parameters is based on the units that are defined for the relevant variables. These units of measurement can be viewed in the UNITS menu in calibration below.

Calibration Menu Tree

Figure 14 and Figure 15 show the keys for moving around the calibration menu tree in Calibration View or Set mode.

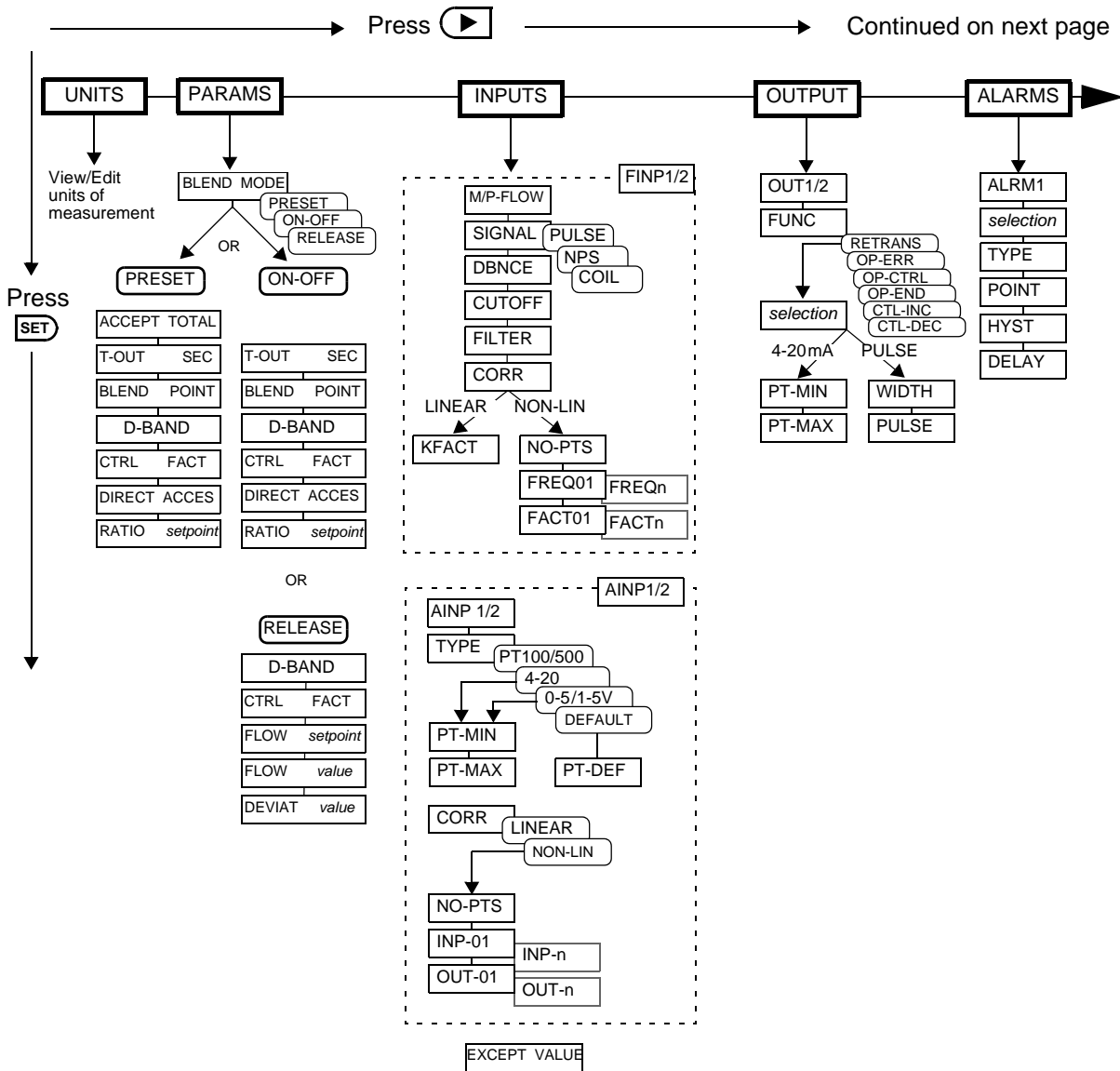

Figure 14 Calibration Menu Tree Sheet 1

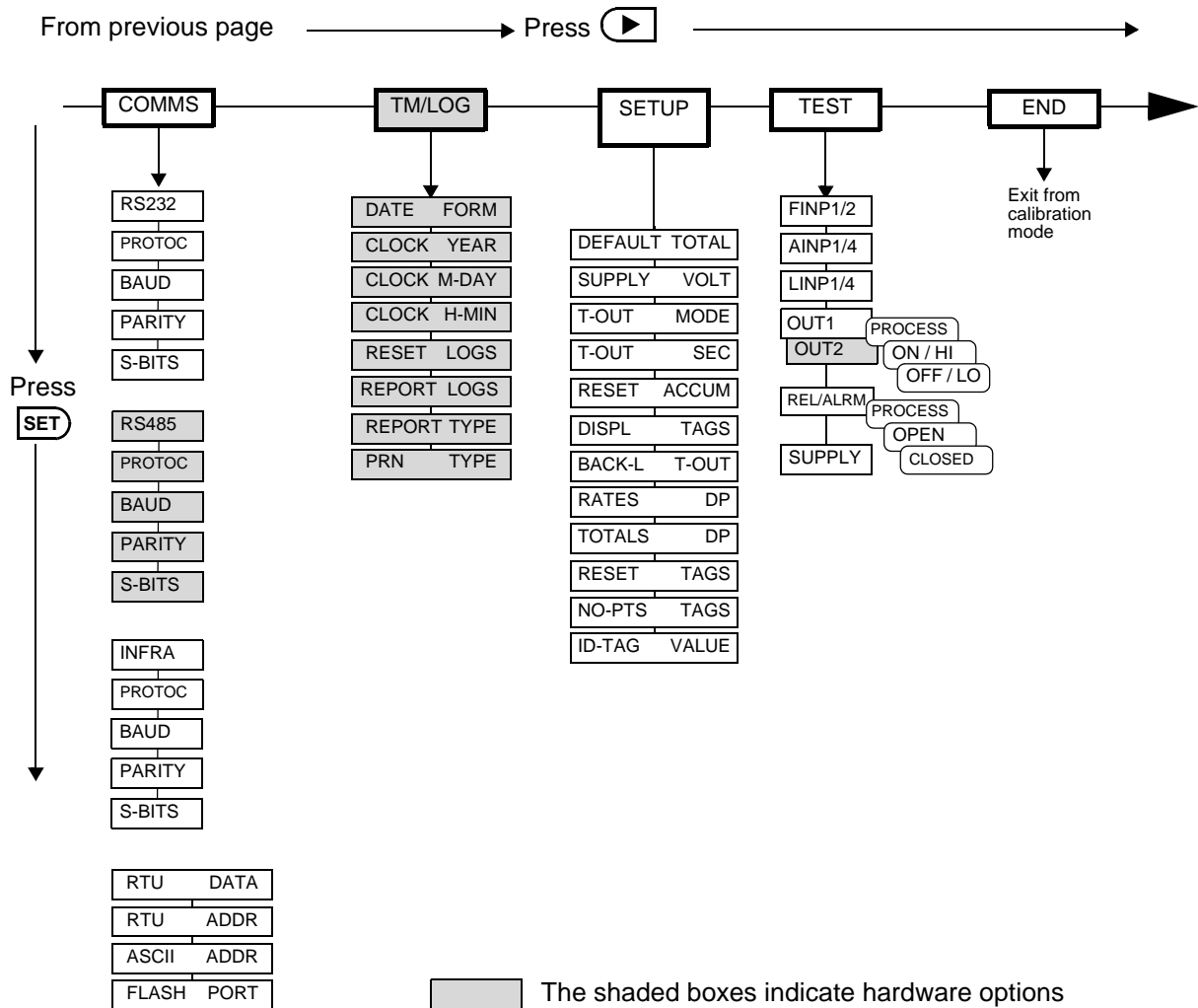









Figure 15 Calibration Menu Tree Sheet 2





Instrument Settings

Units of Measurement

The Units menu allows the units to be viewed and edited if necessary without the reloading of new application software. Any change in units will result in a full reset to initially downloaded settings. Therefore, any required changes to units of measurement should be made before changing any other settings.

 ↓	 → UNITS PARAMS INPUTS OUTPUTS ALARMS COMMS TM/LOG SETUP TEST END
ITEM <i>n</i> <i>unit</i>	<p>The units for main menu or calibration items can be viewed by pressing the  key.</p> <p>The units of measurement are password protected. To edit the units the correct password must be entered on entry to EDIT mode.</p> <p>Press  or  to select the required units. Refer to Available Units of Measurement on page 78 for the list of available units.</p>
ACCEPT UNITS	<p>The Accept Units prompt will only appear if one or more of the units have been changed.</p> <p>IMPORTANT: Accepting the change of units will initiate a master reset. All calibration parameters will revert to their default value (i.e. those values included in the downloaded instrument software). All totals and any logged information will be cleared.</p> <p>Press  or  to select YES, then press the  key. The instrument makes three beeps to confirm the reset command.</p> <p>The message -RESET- PLEASE WAIT will be displayed as the instrument exits calibration mode and completes a full re-boot sequence.</p>

Parameters

 ↓	 → UNITS PARAMS INPUTS OUTPUTS ALARMS COMMS TM/LOG SETUP TEST END
BLEND MODE	<p>Select the required blend operation mode.</p> <ul style="list-style-type: none"> • PRESET - delivery controlled by logic input or Modbus RTU. • ON-OFF - delivery controlled by flow presence. • RELEASE - release flow (loop tuning, only available in calibration mode). <p>Press  or  to select either: PRESET, ON-OFF, or RELEASE.</p> <p>Refer to the section Blending Operation on page 22 for descriptions of each mode.</p>
<p>Note: The items actually shown in the PARAMS menu are dependent on the BLEND MODE chosen above. Items that are not relevant for that mode will not appear. Use the Calibration Menu Tree as a guide to the relevant items.</p>	
ACCEPT TOTAL	<p>The acceptable total is the minimum total for the system leakage to be logged (a value of zero disables logging of leakages). It also allows small totals due to “meter skips” and vibration to be discarded without being considered as a valid delivery.</p>
T-OUT SEC	<p>The flow timeout determines the length of no flow time that the instrument will wait during a delivery before raising a no flow error. It also determines when an overflow error is raised if flow does not cease within the timeout period after the controller attempts to stop the flow. A value of zero disables these flow timeout features.</p> <p>Enter the value in seconds.</p>
BLEND POINT	<p>Blend point location:</p> <p>AFTER: after main line meter</p> <p>BEFORE: before main line meter</p>
DEADBAND Units	<p>The control deadband can be programmed to prevent the output continuously changing and thereby reducing wear on valves and actuators.</p> <p>While the main menu Deviation (error) is within the deadband, the process control signal will remain steady (i.e. the error is treated as zero in the algorithm).</p>
CTRL FACT	<p>The control scaling factor allows fine tuning of the system response by scaling the control signal. Set the factor to lower values to slow down the valve operation.</p>
P-FLOW SP	<p>Loop/Process flowrate setpoint. This setpoint is only available in RELEASE (tuning) operation mode.</p>

SET ↓	▶ → UNITS PARAMS INPUTS OUTPUTS ALARMS COMMS TM/LOG SETUP TEST END
DIRECT ACCESS	<p>If the direct access is enabled, the operator is able to enter edit mode for some parameters directly from the main menu by holding the SET key (see Main Menu Items on page 18 for more details). If disabled, these parameters can only be changed from within the calibration set mode or via Modbus RTU serial communication.</p> <p>Press ▲ or ▼ to select ENABLE or DISABLE.</p>
Modbus Accessible Parameters	
The following PARAMS menu item is also accessible via Modbus communications. For Modbus register listing, refer to Instrument Configuration Parameters on page 66.	
RATIO SP	Target ratio setpoint.

Inputs

SET ↓	▶ → UNITS PARAMS INPUTS OUTPUTS ALARMS COMMS TM/LOG SETUP TEST END
Frequency Input 1 & 2	
INPUT M_FLOW FINP1 P-FLOW FINP2	<p>Frequency Input Channels 1 and 2 are assigned as volumetric flow inputs. Channel 1 is for measuring the main line flow and channel 2 is for the process line flow.</p>
SIGNAL FINP1 FINP2	<p>Frequency input signal type.</p> <p>Press ▲ or ▼ to select COIL, NPS or PULSE.</p>
BOUNCE FINP1 FINP2	<p>Switches and relays have metal contacts to make and break circuits. The contact bounce introduces random signals into the circuit. The instrument has a debounce circuit to eliminate this problem.</p> <p>Note: When the debounce circuit is enabled, the maximum input frequency for large amplitude signals is limited to approximately 500Hz. For low amplitude signals, the maximum frequency can be approximately 200Hz.</p> <p>Press ▲ or ▼ to select ENABLE or DISABLE.</p>

SET ↓	▶ → UNITS PARAMS INPUTS OUTPUTS ALARMS COMMS TM/LOG SETUP TEST END																																													
CUTOFF FINP1 FINP2	<p>The Cut-off is the lowest frequency for which the instrument continues to calculate a rate from the flowmeter.</p> <p>The value for the cut-off is specified as the frequency of the flowmeter in Hertz.</p> <p>Be careful when setting low cut-off values because the display update time for the flow rate becomes very long. For example, if the cut-off is set to 0.01 Hz and the measured flow stops, the instrument continues to display the flow rate for 100 seconds before it can determine that the flow has actually stopped.</p>																																													
FILTER FINP1 FINP2	<p>Input fluctuations caused by pulsating flow tend to create distortion in the input readings of the rate. The instrument has a digital filter that averages out these fluctuations.</p> <p>As a guide to the degree of filtering to use, the following table shows the response time (in seconds) to reach 90% and 99% of a step change in input.</p> <p>The value A is the filter constant that the user can set.</p> <table border="1" style="width: 100%; border-collapse: collapse;"> <thead> <tr> <th style="text-align: center;">Filter setting A</th> <th style="text-align: center;">Seconds to reach 90% of full swing</th> <th style="text-align: center;">Seconds to reach 99% of full swing</th> </tr> </thead> <tbody> <tr><td style="text-align: center;">0</td><td style="text-align: center;">0</td><td style="text-align: center;">0</td></tr> <tr><td style="text-align: center;">2</td><td style="text-align: center;">2</td><td style="text-align: center;">4</td></tr> <tr><td style="text-align: center;">4</td><td style="text-align: center;">4</td><td style="text-align: center;">8</td></tr> <tr><td style="text-align: center;">6</td><td style="text-align: center;">5</td><td style="text-align: center;">10</td></tr> <tr><td style="text-align: center;">10</td><td style="text-align: center;">8</td><td style="text-align: center;">15</td></tr> <tr><td style="text-align: center;">15</td><td style="text-align: center;">12</td><td style="text-align: center;">23</td></tr> <tr><td style="text-align: center;">20</td><td style="text-align: center;">14</td><td style="text-align: center;">27</td></tr> <tr><td style="text-align: center;">25</td><td style="text-align: center;">18</td><td style="text-align: center;">34</td></tr> <tr><td style="text-align: center;">35</td><td style="text-align: center;">25</td><td style="text-align: center;">48</td></tr> <tr><td style="text-align: center;">45</td><td style="text-align: center;">32</td><td style="text-align: center;">62</td></tr> <tr><td style="text-align: center;">60</td><td style="text-align: center;">42</td><td style="text-align: center;">82</td></tr> <tr><td style="text-align: center;">75</td><td style="text-align: center;">52</td><td style="text-align: center;">102</td></tr> <tr><td style="text-align: center;">90</td><td style="text-align: center;">62</td><td style="text-align: center;">122</td></tr> <tr><td style="text-align: center;">99</td><td style="text-align: center;">68</td><td style="text-align: center;">134</td></tr> </tbody> </table> <p>The input filter range is from 0 to 99. A setting of 0 (zero) means that there is no filtering.</p>	Filter setting A	Seconds to reach 90% of full swing	Seconds to reach 99% of full swing	0	0	0	2	2	4	4	4	8	6	5	10	10	8	15	15	12	23	20	14	27	25	18	34	35	25	48	45	32	62	60	42	82	75	52	102	90	62	122	99	68	134
Filter setting A	Seconds to reach 90% of full swing	Seconds to reach 99% of full swing																																												
0	0	0																																												
2	2	4																																												
4	4	8																																												
6	5	10																																												
10	8	15																																												
15	12	23																																												
20	14	27																																												
25	18	34																																												
35	25	48																																												
45	32	62																																												
60	42	82																																												
75	52	102																																												
90	62	122																																												
99	68	134																																												
CORR FINP1 FINP2	<p>If the input sensor has non-linear characteristics, select NON-LINEAR to apply correction factors to the input signal.</p> <p>Use ▲ or ▼ to select LINEAR or NON-LINEAR.</p>																																													

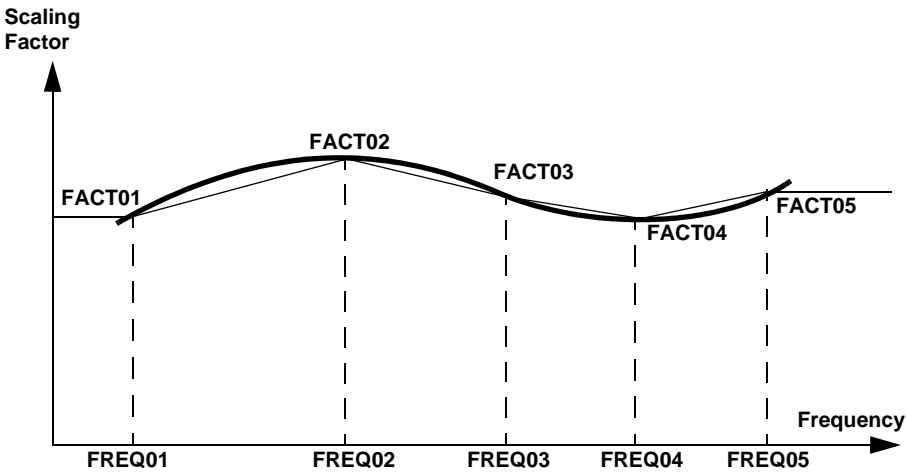
<p>SET ↓</p>	<p>▶ → UNITS PARAMS INPUTS OUTPUTS ALARMS COMMS TM/LOG SETUP TEST END</p>
<p>KFACT1 unit KFACT2 unit</p>	<p><i>This parameter is available for viewing and editing only when the correction type is set to Linear.</i></p> <p>The K-factor of the flowmeter is the number of pulses from the flowmeter per unit of volume. The K-factor cannot be 0 (zero).</p>
<p>NO-PTS FINP1 FINP2</p>	<p><i>This parameter is available for viewing and editing only when the correction type is set to Non-linear.</i></p> <p>Enter the number of non-linearity correction points.</p> <p>Press ▲ or ▼ to select a number between 1 and 10 for the number of correction points.</p>
<p>FREQ01 FINP1 to FREQn</p> <p>FREQ01 FINP2 to FREQn</p>	<p><i>This parameter is available for viewing and editing only when the correction type is set to Non-linear.</i></p> <p>Enter the frequency for this correction point.</p> <p>The instrument uses linear interpolation between the correction points except that the correction factor for FREQ01 is used from 0Hz up to FREQ01. Similarly, the instrument maintains the correction factor for the highest frequency setting up to the maximum input frequency.</p> <p>The following diagram shows the scaling factors at different frequencies for a hypothetical flowmeter. The heavy black line represents the actual scaling factor of the flowmeter. The light black line is the approximation that the instrument uses.</p>  <p>Enter the lowest correction factor frequency as FREQ01 and proceed up to the highest frequency. You can press the DISPLAY key to skip the non-linear points and go to the next item.</p>

SET ↓	▶ → UNITS PARAMS INPUTS OUTPUTS ALARMS COMMS TM/LOG SETUP TEST END
FACT01 FINP1 to FACTn	<i>This parameter is available for viewing and editing only when the correction type is set to Non-linear.</i>
FACT01 FINP2 to FACTn	Enter the scaling factor for this correction point. The correction factor cannot be 0 (zero).
Analog Inputs 1 & 2	
INPUT AINP1 AINP1 AINP2 AINP2	For this application, Analog Input Channels 1 and 2 serve as the general purpose inputs and can be used for reading fluid levels, etc.
TYPE AINP1 AINP2	Select the type of analog input source. Press ▲ or ▼ to select 0-5V, 1-5V, 4-20mA, PT100, PT500 or DEFAULT.
PT-DEF AINP1 AINP2	The Default Point is a fixed value that the instrument uses when the Input Type is set to DEFAULT or Default Value On Exception has been ENABLED. You can use the Default value instead of a sensor signal for testing purposes, or if the sensor is faulty. You can set the default value during instrument commissioning so that it is available immediately if you select the Default input type at a later date. Enter the value in the engineering units of assigned variable.
PT-MIN AINP1 PT-MAX AINP2	<i>The Minimum Point and Maximum Point parameters are only for 0-5V, 1-5V and 4-20mA inputs.</i> Enter the value of the measured parameter that corresponds to the minimum input signal level. The minimum point is commonly referred to as the base value. Enter the value of the measured parameter that corresponds to the maximum input signal level. The maximum point is the same as the base value (set at the minimum point) plus the span value. For example, if the source signal is 4mA for a level of 1.0 metre, enter 1.000 for the minimum point. If the source signal is 20mA for a level of 5 metres, enter 5.000 as the maximum point.
CORR AINP1 AINP2	Analog input non-linearity can be corrected as follows: <ul style="list-style-type: none"> • LINEAR • NON-LINEAR to use the following linearity correction parameters Use ▲ or ▼ to select LINEAR or NON-LINEAR.

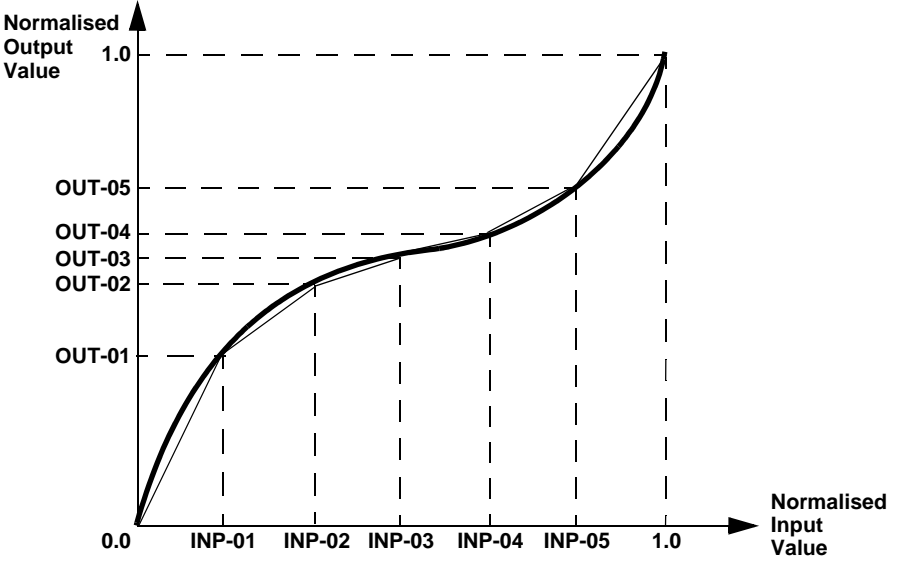
<p>SET ↓</p>	<p>▶ → UNITS PARAMS INPUTS OUTPUTS ALARMS COMMS TM/LOG SETUP TEST END</p>
<p>NO-PTS RINP1 RINP2</p>	<p><i>This parameter is available for viewing and editing only when the correction type is set to Non-linear.</i></p> <p>Enter the number of non-linearity correction points.</p> <p>Press ▲ or ▼ to select a number between 1 and 20 for the number of correction points.</p>
<p>INP-01 RINP1 to RINP2 INP-n</p>	<p><i>This parameter is available for viewing and editing only when the correction type is set to Non-linear.</i></p> <p>Enter the normalised input value for the correction point.</p> <p>The instrument uses linear interpolation between the correction points. An input and an output value are entered for each correction point. The values are normalised between the minimum point (0.0) and the maximum point (1.0). Only the points between 0 and 1 are required to be entered and should be entered in ascending order.</p> <p>The following diagram shows a 5 point linearised representation of the input for a hypothetical flowmeter. The heavy black line represents the actual input from the flowmeter. The light black line is the approximation that the instrument uses.</p>  <p>You can press the DISPLAY key to skip the non-linear points and go to the next item.</p>

SET ↓	▶ → UNITS PARAMS INPUTS OUTPUTS ALARMS COMMS TM/LOG SETUP TEST END
OUT-01 RINP1 to RINP2 OUT-n	<p><i>This parameter is available for viewing and editing only when the correction type is set to Non-linear.</i></p> <p>Enter the normalised output value for the correction point.</p>
EXCEPT VALUE	<p>This option allows you to choose which value the instrument will use for the analog input that raised an exception. The exception message will continue to be displayed until the fault is rectified or the input type is set to DEFAULT in calibration set mode.</p> <p>Press ▲ or ▼ to select the value on exception as follows:</p> <p>NONE Value will be set to zero DEFAULT Value will be set to the default point if exists, otherwise zero BOUNDS Value will be set to the boundary limit (min or max point)</p>

Outputs

SET ↓	▶ → UNITS PARAMS INPUTS OUTPUTS ALARMS COMMS TM/LOG SETUP TEST END
FUNC OUT _n	<p>The output can function as either a pulse output for retransmission of totals, a no flow error signal, a pump control output, an end of batch signal, or a process flow increase/decrease control output.</p> <p>Press ▲ or ▼ to select RETRANS, OP-ERR, OP-CTRL, OP-END, CTL-INC, or CTL-DEC</p>
PULSE or 4-20 OUT _n	<p>You can assign any of the “main menu” variables to an output. The nature of the output depends on the assigned variable. Totals are output as pulses and rates are output as 4-20mA passive signals.</p> <p>Press ▲ or ▼ to select the variable that is required as an output. The top of the display shows the type of output signal that is assigned to the variable.</p> <p style="text-align: center;">CAUTION</p> <p style="text-align: center;">Due to the dual-purpose nature of the outputs, take care not to set the output as an open collector pulse type signal when connected to a 4-20mA loop circuit.</p>
WIDTH OUT _n	<p><i>The Output Pulse Width is available for viewing and editing only when the assigned variable is a total (pulse output) type.</i></p> <p>Pulse output is usually used to drive remote counters. Set the pulse width (in milliseconds) as required by the remote counter.</p> <p>Press ▲ or ▼ to set to: 10, 20, 50, 100, 200 or 500ms.</p>

<div style="display: inline-block; border: 1px solid black; padding: 2px;">SET</div> ↓		<div style="display: inline-block; border: 1px solid black; padding: 2px;">▶</div> → UNITS PARAMS INPUTS OUTPUTS ALARMS COMMS TM/LOG SETUP TEST END
PULSE	OUTn	<p><i>The Output Pulse Factor is available for viewing and editing only when the assigned variable is a total (pulse output) type.</i></p> <p>The Output Pulse Factor is the scaling factor for the retransmission of the measured total quantity.</p> <p>For example, if “volume” is chosen as an output variable and engineering unit is cubic metres, then a pulse factor of 1.000 generates one pulse for 1 m³. Similarly, a pulse factor of 3.000 generates one pulse for 3 m³.</p> <p>For more information, see Output Pulse Factor on page 40.</p> <p>The output pulse factor cannot be 0 (zero).</p>
PT-MIN PT-MAX	OUTn OUTn	<p><i>The Output Minimum Point and Maximum Point are available for viewing and editing only when the assigned variable is a rate (4-20mA output) type.</i></p> <p>The output minimum value corresponds to the 4 mA point and the output maximum value corresponds to the 20 mA point.</p> <p>Setting the output range differently from the input range enables the instrument to amplify the input signal. You can drive a chart recorder that “zooms in” on a specified range of values instead of displaying the full operating range of the transducer.</p> <p>For example, if “volume flow” is chosen as an output variable and engineering unit is cubic metres per minute, then setting the minimum point to 30 and the maximum point to 100 would reflect the volumetric flow rate range of 30 to 100 m³/min. At rates above the maximum and below the minimum points, the output remains at 20 mA and 4 mA respectively.</p>

Output Pulse Factor

Increasing the output pulse width reduces the maximum frequency at which a total variable can be retransmitted. Pulses will be missed if the output cannot “keep up” with the rate of total counts. You can use the output pulse factor to ensure that this maximum is not reached.

The maximum pulse output frequency is determined by:

$$\frac{1000}{(2 \times \text{pulse width in ms})} \text{ Hz}$$

The minimum pulse factor required is determined by:

$$\frac{\text{max rate of total}}{\text{max pulse output frequency}}$$

For example: To calculate the required pulse factor to avoid losing counts in retransmission if a total counts at a maximum rate of 75 units/sec (Hz) and the required pulse width of a remote counter is at least 50ms:

$$\text{The maximum pulse output frequency is: } \frac{1000}{2 \times 50} = 10\text{Hz}$$

$$\text{The minimum pulse factor for that frequency is: } \frac{75}{10} = 7.5$$

Alarms

The alarm relay(s) can be assigned to rate variables such as flow rate, or set as an equipment failure alarm.

The alarm switches “on” whenever an alarm condition exists. The alarm switches “off” when the alarm condition no longer exists. However, you may need to configure external alarm devices that require acknowledgement for cancelling an alarm.

Equipment Failure Alarm

Any alarm relay can be assigned as an equipment failure alarm. This alarm setting can have normally closed (open) contacts that open (close) when the instrument displays any error message as listed in [Error Messages](#) on page 51.

<input type="button" value="SET"/> ↓	<input type="button" value="▶"/> → UNITS PARAMS INPUTS OUTPUTS ALARMS COMMS TM/LOG SETUP TEST END
RELAY ALRM _n	<p>Select a rate variable to assign to the alarm relay.</p> <p>Note: If the alarm type is set to “equipment alarm”, this relay assignment setting is ignored.</p> <p>Press <input type="button" value="▲"/> or <input type="button" value="▼"/> to select the variable that is required as an alarm.</p>
TYPE ALRM _n	<p>The options available for alarm types are as follows:</p> <ul style="list-style-type: none"> • HI-NO - High Alarm, contacts are Normally Open • HI-NC - High Alarm, contacts are Normally Closed • LO-NO - Low Alarm, contacts are Normally Open • LO-NC - Low Alarm, contacts are Normally Closed • BD-NO - Band Alarm, contacts are Normally Open • BD-NC - Band Alarm, contacts are Normally Closed • AL-NO - Equipment Alarm, contacts are Normally Open • AL-NC - Equipment Alarm, contacts are Normally Closed <p>Press <input type="button" value="▲"/> or <input type="button" value="▼"/> to select the type of alarm required.</p>
POINT ALRM _n	<p><i>The Alarm Setpoint is available for viewing and editing for any alarm type except ‘equipment alarms’.</i></p> <p>The Alarm Setpoint is the value (in engineering units of assigned variable) at which the alarm condition occurs and therefore the alarm is on.</p> <p>Each alarm is completely independent, e.g. a High alarm does NOT need to have a higher setpoint than the a Low alarm.</p>

SET ↓	▶ → UNITS PARAMS INPUTS OUTPUTS ALARMS COMMS TM/LOG SETUP TEST END
HYST ALRMn	<p><i>The Alarm Hysteresis is available for viewing and editing for any alarm type except 'equipment alarms'.</i></p> <p>Alarm hysteresis loops occur when the alarm toggles continuously on and off when the process variable is close to the setpoint.</p> <p>For a high alarm, the alarm activates when the value of the variable rises above the alarm setpoint and deactivates when the value falls below the alarm setpoint minus the amount of the hysteresis setting (if any).</p> <p>For a low alarm, the alarm activates when the value of the variable falls below the alarm setpoint and deactivates when the value rises above the alarm setpoint plus the amount of the hysteresis setting (if any).</p> <p>For a band alarm, the alarm activates whenever the value of the variable is outside the setpoint plus or minus the amount of the hysteresis.</p> <p>For example, with a high alarm setpoint of 200, and a hysteresis setting of zero, a value oscillating between 197 and 202 will cause the alarm to toggle on at 200 and toggle off below 200. However, if the hysteresis is set to 5, the value of the variable must fall below 195 to cancel the alarm. The alarm will reactivate only when the value again rises above 200.</p>
DELAY ALRMn	<p>The Alarm Delay is programmed in seconds and can be used to eliminate undesired alarm activation during start-up or shutdown operation.</p>

Communications

The instrument has three communication ports:

- **RS-232 Port** - A 9-pin female connector on the rear panel of the instrument.
- **Infra-red Port** - Located on the front panel, below the status indicators.
- **RS-485 Port** - (optional) Terminals on the rear panel.

SET ↓		▶ → UNITS PARAMS INPUTS OUTPUTS ALARMS COMMS TM/LOG SETUP TEST END
PROTDC RS232 RS485 INFRA		<p>The Communications Protocols can be assigned to the communication ports as follows (a protocol cannot be assigned to more than one port at a time):</p> <ul style="list-style-type: none"> • ASCII - Simple ASCII available for all ports • RTU - Modbus RTU available for all ports • ID-TAG - iButton LINK45 available for all ports • PRN - Printer Protocol available for RS232 and RS485 • NONE - If a port is not being used, set the protocol to NONE. <p>Printer Protocol (PRN) is only available if the option with Real Time Clock is installed.</p> <p>For the selected port, press ▲ or ▼ to select the desired protocol.</p>
BAUD	RS232 RS485 INFRA	<p>The Baud setting is the speed of the communication port in data bits per second.</p> <p>The baud rate of the instrument must match the baud rate of the communication device that the instrument is connected to.</p> <p>Use ▲ or ▼ to select 2400, 4800, 9600 or 19200 baud.</p>
PARITY	RS232 RS485 INFRA	<p>The Parity bit helps to detect data corruption that might occur during transmission.</p> <p>The parity bit setting of the instrument must match the parity bit setting of the communication device that the instrument is connected to.</p> <p>Press ▲ or ▼ to select EVEN, ODD, or NONE.</p>
S-BITS	RS232 RS485 INFRA	<p>The Stop bit indicates the end of a transmission. Stop bits can be 1 or 2 bit periods in length. The stop bit setting of the instrument must match the stop bit setting of the communication device that the instrument is connected to.</p> <p>Press ▲ or ▼ to select 1 or 2 stop bits.</p>
RTU	DATA	<p>The Modbus RTU data format for the 2-register (4-byte) values can be set as either floating point or long integer values.</p> <p>Use ▲ or ▼ to select FLOAT or INTEGER.</p>

<input type="button" value="SET"/> ↓		<input type="button" value="▶"/> → UNITS PARAMS INPUTS OUTPUTS ALARMS COMMS <small>TM/LOG SETUP TEST END</small>
RTU	ADDR	<p>The Modbus RTU protocol address must be in the range of 1 to 247. When multiple instruments (slaves) are connected to one communication device (master), each assigned address must be unique.</p> <p>Note: The master device uses the RTU address 0 (zero) for broadcasting to all connected slave units.</p>
ASCII	ADDR	<p>The ASCII protocol address identifies each communicating device.</p> <p>The address must be in the range of 1 to 255. When multiple instruments (slaves) are connected to one computer (master), each assigned address must be unique.</p>
FLASH	PORT	<p>The Flash Driver Port assignment defines the communication port for downloading software into the instrument.</p> <p>The default setting of this assignment is the RS-232 port.</p> <p>Press <input type="button" value="▲"/> or <input type="button" value="▼"/> to select RS-232, RS-485, or INFRA.</p>

Time Settings and Data Logging

Instrument Clock

Note: The real-time clock is part of the advanced option package.

The instrument has a real-time clock for recording logged events. The clock displays the time and the date. The date format can be set to European format (day/month/year) or American format (month/day/year). The time clock uses the 24-hour format.

The clock will continue to operate for up to 5 years (typically) on the internal battery if there is no power connected to the instrument. Therefore, after an interruption to the power supply, the instrument recommences normal operation although there will be no data recorded during the period without a power supply.

Note: If there is an interruption to the power supply and the battery has failed, the instrument displays an error message when the power supply is restored. In this case, you should set the current time and date so that the instrument continues to log data at the correct times.

Data Logging

The instrument will log a total of 1000 deliveries (batches) if the real-time clock option is installed. The logs are taken at the end of each batch.

[SET] ↓		▶ → UNITS PARAMS INPUTS OUTPUTS ALARMS COMMS TM/LOG SETUP TEST END
DATE	FORM	<p>Clock Date Format</p> <p>The European date format is: dd/mm/yyyy or (Day-Month).</p> <p>The American date format is: mm/dd/yyyy or (Month-Day).</p> <p>Press ▲ or ▼ to select DAY-M or M-DAY</p>
CLOCK	YEAR	The Clock Year defines the current year for the real-time clock.
CLOCK	M-DAY	The Clock M-DAY setting defines the current month and date for the real-time clock. This parameter is programmed in Month-Day format for both European and American date formats.
CLOCK	H-MIN	The Clock H-MIN setting is the current time in hours and minutes for the real-time clock.
RESET	LOGS	<p>Reset the logged data. You may need to reset (clear) the logged data if you change the time/log settings.</p> <p>Press ▲ or ▼ to select YES, then press the [SET] key. The instrument makes three beeps to confirm the reset command.</p>
REPORT	LOGS	<p>The Printer Protocol Report Logs defines the number of latest logs to be included into a printable report.</p> <p>Enter the number of logs between 0 and 99.</p>
REPORT	TYPE	<p>The Printer Protocol Report Type determines the nature of the printout from the REPORT PRINT - HOLD.SET prompt in the main menu. The following report types available in this instrument are:</p> <ul style="list-style-type: none"> • REP-10 Preset number of latest logs <p>Press ▲ or ▼ to select Report Type.</p>
PRN	TYPE	<p>The Printer Protocol Printer Type allows the nature of the printer being used to be specified. The following printer types available in this instrument are:</p> <ul style="list-style-type: none"> • PRN-01 Generic computer printer • PRN-02 Generic roll printer (prints first line first) • PRN-03 Slip printer TM295 <p>Press ▲ or ▼ to select Printer Type.</p>

General Setup Parameters

SET ↓	▶ → UNITS PARAMS INPUTS OUTPUTS ALARMS COMMS TM/LOG SETUP TEST END
DEFAULT TOTAL	<p>The instrument displays the default Total when the user presses the TOTAL key or when the timeout period has elapsed if it is enabled.</p> <p>Press ▲ or ▼ to select the default total display.</p>
SUPPLY VOLT	<p>The instrument provides a power-limited supply for external transducers.</p> <p>Press ▲ or ▼ to set the transducer supply voltage between 8 and 24 volts DC as required.</p>
T-OUT MODE	<p>If the Display Timeout mode is enabled, and there is no user activity for the defined timeout period, the display panel returns to the default display.</p> <p>This function is useful for the following reasons:</p> <ul style="list-style-type: none"> • to return the display to a preferred variable after the user has finished reading other information, • to cancel the calibration mode and return to the default display if the user does not exit from the calibration mode for any reason. <p>Press ▲ or ▼ to select the display timeout function as follows:</p> <ul style="list-style-type: none"> • DISABLE - Timeout is completely disabled. • EN DISP - Timeout is enabled during Normal mode and Calibration View mode. • EN EDIT - Timeout is enabled during Calibration Set mode. • EN ALL - Timeout is enabled for all modes.
T-OUT SEC	<p>The Display Timeout period defines the delay for the Display Timeout mode if it is enabled.</p> <p>The display timeout period can be from 10 to 99 seconds.</p>
RESET ACCUM	<p>The Reset Accumulated Totals function clears all of the accumulated totals and the non-accumulated totals.</p> <p>Press ▲ or ▼ to select YES, then press the SET key. The instrument makes three beeps to confirm the reset command.</p>

SET ↓	▶ → UNITS PARAMS INPUTS OUTPUTS ALARMS COMMS TM/LOG SETUP TEST END
DISPL TAGS	<p>The Display Tags option determines whether the instrument displays the default display tags or the user-defined tags. The display tag setting also defines whether the instrument displays the default error and warning messages, or the user-defined messages.</p> <p>Note: The user-defined tags can be entered into the instrument only by the manufacturer or the distributor.</p> <p>Press ▲ or ▼ to select the Display Tags option as follows:</p> <ul style="list-style-type: none"> • DEFAULT - the instrument displays the default (English) tags • USER - the instrument displays the user-defined tags.
BACK-L T-OUT	<p>If the backlight timeout is enabled, and there is no user activity (any keys pressed) for a period of 10 seconds, the display backlight switches off to save power. The backlight switches on when a key is pressed. Select the backlight timeout mode as required.</p> <p>Press ▲ or ▼ to select ENABLE or DISABLE.</p>
RATES DP	<p>This parameter sets the maximum number of decimal places for displaying or printing main menu rates.</p>
TOTALS DP	<p>This parameter sets the maximum number of decimal places for displaying or printing main menu totals.</p>
<p>The following ID Tag parameters are only shown if the ID-TAG protocol has been assigned to one of the serial ports in Communications on page 43.</p>	
RESET TAGS	<p>The ID Tags Reset function clears all of the stored identification tag numbers.</p> <p>Press ▲ or ▼ to select YES, then press the SET key. The instrument makes three beeps to confirm the reset command.</p>

SET ↓	▶ → UNITS PARAMS INPUTS OUTPUTS ALARMS COMMS TM/LOG SETUP TEST END
No --PTS TAGS	<p>The instrument can store up to 100 valid identification tag numbers. To reduce the need to step through an unnecessary number of unused points this parameter allows the amount of tags to be entered.</p> <p>Press ▲ or ▼ to select a number between 1 and 100.</p>
ID-TAG to ID-TAG 001 n	<p>The new ID Tag number is entered by touching the relevant “iButton” security tag (key) to the tag reader. The new tag number overwrites any existing number in that location. If the wrong tag is entered, it can be overwritten with the correct tag or cleared by pressing and holding the RESET key.</p> <p>The ID Tag values can also be accessed and edited via Modbus communications, see Valid Identification Tag Numbers on page 66.</p> <p>The instrument also allows to assign a target ratio percentage to each ID Tag. The list of options provides 16 different values from 0% to 100%.</p> <p>Press ▲ or ▼ to assign a desired ratio percentage to the current tag.</p>

Test Menu

The Test menu enables you to view the inputs and outputs to and from the instrument.

In Calibration Set mode (by entering the system password), you can control the outputs and the alarms as described in the table below.

SET ↓	▶ → UNITS PARAMS INPUTS OUTPUTS ALARMS COMMS TM/LOG SETUP TEST END
FINP _n Hz	The frequency of the input to FINP _n is displayed in Hertz.
AINP _n Units	The units are displayed according to the calibration setup for the analog input. If unused or set to Default the input is 4-20mA and displayed in mA.
LINP _n STATE	You can view the state of the logic inputs. If the input is an open contact or inactive it will display HI . If the input is a closed contact or active it will display LO .

SET ↓	▶ → UNITS PARAMS INPUTS OUTPUTS ALARMS COMMS TM/LOG SETUP TEST END
OUT _n STATE	<p>You can control the state of the outputs. Press the ▲ or ▼ keys to set the output state as follows:</p> <ul style="list-style-type: none"> • PROCESS - the output depends on the current values of the inputs and the calculations that the instrument performs. <p>For a pulse output, such as a total, the output produces a pulse train as follows:</p> <ul style="list-style-type: none"> • ON - a pulse train with a pulse width as set in the Outputs menu. • OFF - no output. <p>For a 4-20mA output, such as a rate, the output is as follows:</p> <ul style="list-style-type: none"> • HI - the output is set to 20mA. • LO - the output is set to 4mA.
ALRM _n STATE or REL -n	<p>You can control the state of the relays (alarms). Press the ▲ or ▼ keys to set the selected relay as follows:</p> <ul style="list-style-type: none"> • PROCESS - the relay operates according to the current values of the inputs and the relay settings as programmed. • OPEN - the relay output contacts are set to “open”. • CLOSED - the relay output contacts are set to “closed”.
SUPPLY ✓	<p>You can display the actual DC output supply voltage, which may help with troubleshooting.</p> <p>If the actual supply voltage is lower than the preset value (refer to General Setup Parameters on page 47) it may indicate that the output is overloaded.</p>

System Messages

The instrument displays messages for defined events and fault conditions.

The manufacturer or distributor can enter user-defined text for the messages. This user-defined text is displayed, instead of the default (English) messages, when the Display Tags option in the Setup menu is set to USER.

Error Messages

Failure of Analog Input Sensor

If there is a failure of an analog input sensor for a process parameter such as level of fluid, the instrument sets the value of that parameter in accordance with the **EXCEPT VALUE on page 39** and displays the relevant error message. The input sensor and connections need to be inspected and may require replacement.

Override Error Condition

While a fault is being rectified on an analog input for a process parameter, an operator with calibration access can set the Analog Input Signal Type to DEFAULT and the Analog Input Default Point to a typical process value. If there are no other faults, the instrument continues to operate by using the default value.

The instrument displays error messages as described in the following table:

Error Messages	Description
CPU Card Failure	There are failed components on the CPU card and technical support is required.
Power Supply is Low	The input and/or output power supply voltage is too low, ensure that: (a) input power supply voltage is within the specified range (b) output power supply is not overloaded.
New/Failed Battery - Set Time	The real-time clock has lost the correct time because the battery has failed, or there is a new battery. Set the current time and date (in the TM/LOG menu) to clear the error message and to continue data logging at the correct times. Note: The instrument can continue operating with a failed battery, but the correct time will be lost if there are interruptions to the power supply.
Analog Input 1 Signal Failure	The analog input 1 signal is outside allowed limits. To deactivate the error, the Analog Input Signal Type can be set to DEFAULT to use a programmed default value instead of the sensor signal.
Analog Input 2 Signal Failure	The analog input 2 signal is outside allowed limits. To deactivate the error, the Analog Input Signal Type can be set to DEFAULT to use a programmed default value instead of the sensor signal.
No Flow Detected	The “no flow” condition is detected when the flow timeout expires during a delivery. There must not be a period of no flow greater than the timeout value during the delivery.

Error Messages	Description
Overflow Detected	The “overflow” condition is detected when the flow continues longer than the timeout period after attempting to stop the flow.
Leakage Detected	The “leakage” condition is detected when an amount greater than the acceptable total is received without starting a delivery.

Warning Messages

The instrument displays warning messages as described in the following table:

Warning Messages	Description
Value Has Been Set to Default	You have entered an invalid value for a parameter. Therefore, the instrument has set the default value.
Already Assigned to Other Port	You have tried to assign a particular protocol type to more than one serial communication port. The instrument has set the protocol to NONE.

Prompt Messages

The instrument displays prompt messages as described in the following table:

Prompt Messages	Description
Validate ID Tag	Validate ID Tag to proceed with delivery.
Start Delivery	Activate delivery via Permissive Input or Modbus RTU command.

Chapter 6

Communications

Overview

This chapter describes the communications between the instrument and another communicating device such as a computer or a printer. You should have relevant information about the devices to which the instrument will be connected. Some connection examples are included in this manual, however, the operation and connection of other devices is outside the scope of this manual.

Hardware Interconnection

The instrument has three communication ports:

- RS-232 port on the rear panel (DB9 female connector)
- RS-485 port on the rear panel (optional)
- Infra-red port on the front panel

The appropriate interface and protocols are selected during calibration.

RS-232 Port

The RS-232 port provides communication between the instrument and another device such as a host computer or a printer.

Note: A printer must have a serial port to be able to be directly connected to the flow computer. It is not possible to communicate directly with a printer via a parallel port.

Computers use either a DB9 or a DB25 connector, and the connections to each type are shown in Figure 16.

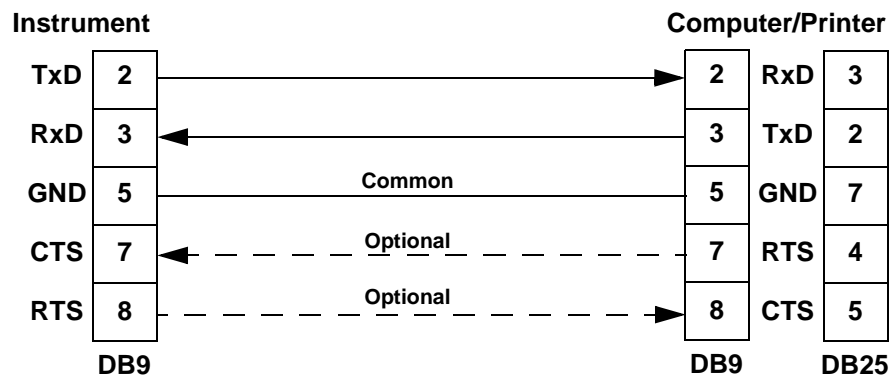

Figure 16 RS-232 Cable Connections to a Computer

Note: The instrument requires a cable with straight-through connections. Do not use a null modem cable for RS-232 connection to a computer.

RS-485 Port

The RS-485 port enables communication with multiple devices. Each device has a unique address so that the “master” device can communicate with specific “slave” devices.

On RS-485 links, an external terminating resistor must be connected at the furthest end of the cable. When multiple instruments are connected, they should be “daisy chained” in a multidrop configuration as shown in Figure 17. Up to 32 units can be connected to the interface at a maximum distance of 1200 metres.

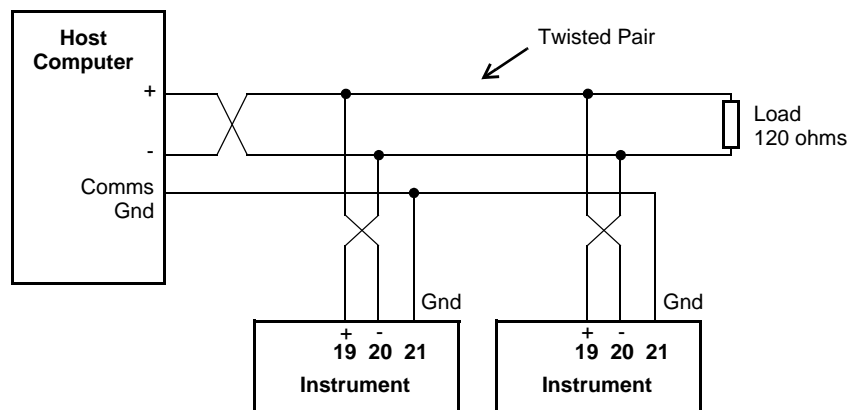

Figure 17 RS-485 Connections

Infra-red Port

The infra-red port is located on the front panel of the instrument. The infra-red port uses the Infra-red Developers Association (IrDA) physical layer format of signal encoding and decoding.

The nature of the infra-red port requires the communicating device to be located close to the front of the instrument. Therefore, its main use would probably be for reloading the instrument application software, or occasional collection of data, rather than continuous communications.

Protocols

The communications protocols can be assigned to the communication ports on the instrument as follows:

- **ASCII** - Simple ASCII available for all ports
- **RTU** - Modbus RTU available for all ports
- **ID-TAG** - iButton LINK45 available for RS232 and RS485
- **PRN** - Printer Protocol available for RS232 and RS485
- **NONE** - If a port is not being used, set the protocol to NONE.

Note: The Printer Protocol is only available if the option with Real Time Clock is installed. Also a protocol cannot be assigned to more than one port at a time as described in [Communications](#) on page 43.

- **ASCII** - In this ASCII protocol each command and response is a string of ASCII characters. This proprietary protocol is developed by Contrec to allow for simple information interchange. The main advantages of this mode are that it allows extended time intervals to occur between characters without causing a timeout error and that messages can be sent and monitored easily with a simple ASCII terminal.
- **Modbus RTU** - Modbus RTU is an industry-standard protocol which allows the instrument to be easily connected to computers running supervisory software systems. The main advantage of this mode is that its greater character density allows better data throughput than ASCII mode, however each message must be transmitted in a continuous stream.
- **iButton ID-TAG** - This protocol allows an external “iButton LINK45” module to be connected to 515 instrument to read identification tags to ensure only authorised deliveries are made.
- **Printer** - In the Printer protocol there is a selection of printer types. Please refer to the [Printer Protocol](#) on page 68 for full details.

Simple ASCII Protocol

This simple ASCII protocol requires that all requests are initiated with a colon (:) and terminated with a carriage return (C_R). The message termination can include a linefeed before the carriage-return ($L_F C_R$), but it is the carriage-return that acts as the message termination.

All responses by the instrument are terminated with a linefeed and a carriage-return ($L_F C_R$).

Requests Format

The format of a request to the instrument is as follows:

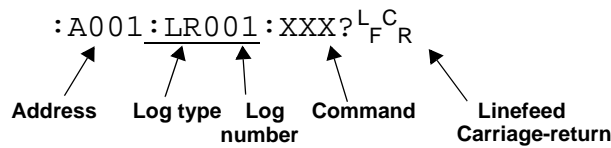

Each request must include the address and command portions. The underlined section is an optional part of the request string.

Address

In multipoint communications, each instrument must have a unique address and it is essential in the request for identifying a particular instrument. However, it may be set to 000, for special broadcast commands.

For single-instrument communications, the address can also be set to 000 in the request.

Refer to [Communications](#) on page 43 for setting the instrument address.

Note: The instrument always responds with its address in the header regardless of the type of request.

Log Type and Number

The log type and number enables a communicating device to retrieve data from the instrument. The data can be from the event-based logs or from the current process variables.

The log request is optional. If the log request is not included, or the log number is set to 000, the instrument returns the current process variables. If the log request is included, the log number defines the specific log entry by counting backwards. The most recent log entry for a timebase is 001.

The “last edit” log records the process variables at the time of the last exit from the calibration edit mode. There is only one “last edit” log, therefore, if a number is included in the request, the instrument ignores the number and returns the data at the time of the last edit.

The types of logs applicable to this instrument are as follows:

Log Type
LE - last edit log
LR - logged records (non-timebased logging)
LN - current totals displayed as Non-accumulated

The number of the log entry is the same as shown on the front panel of the instrument. For example, a request for LR003 would return the data for the log entry two batches prior to the most recent batch log entry.

Instrument Responses

The instrument response time to any enquiry is no more than 300ms. The responses from the instrument are in the following format:

```

HEADERLFCR
DATALFCR
DATALFCR
.
.
.
DATALFCR
LFCR
    
```

The components of the response message are as follows:

Header

The format of the response header from the instrument is as follows:

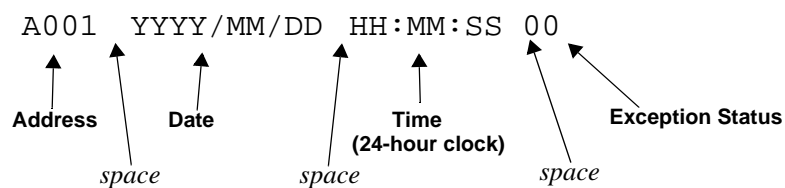

The instrument **Exception Status** codes that the instrument returns for the ASCII protocol are the same as those described for the Modbus RTU protocol in [Instrument Exception Status](#) on page 64.

Data

The format of the data variables from the instrument is as follows:

8 9 1 2 3 . 4 5 6								M W h							E N E R G Y											
1	2	3	4	5	6	7	8	9	10	11	12	13	14	15	16	17	18	19	20	22	23	24	25	26	27	
Value (aligned right)											space	Unit (aligned left)							space	Item (aligned left)						

Note: The decimal point in the Value is always at character position 8. Therefore whole numbers are aligned right at the decimal point, with trailing zeroes.

Variables Request

The variables request asks the instrument to return the value of one or more requested variables. All totals are transmitted as accumulated totals.

Command	Description
:RVA?	Return all variables
:RVD?	Return the default Total and Rate
:RV0? ... :RV9?	Return the specific variable. The numbers relate to the position in the variables menu. For example, V0 is Energy, V1 is Power and so on.

Variables Request and Response Example

The following request is for the only instrument that is connected to the communication port to return the values of all main menu variables.

```
: A 0 0 1 : R V A ? LF CR
```

The following is an example of a hypothetical instrument response. Refer to on page 25 for the list of variables that would be returned for this application.

```
A 0 0 1 2 0 0 2 / 0 3 / 1 4 1 8 : 2 5 : 0 0 0 0 LF CR
      6 . 1 1 6 M W h E N E R G Y LF CR
      1 6 . 5 7 3 M W P O W E R LF CR
      1 3 2 0 . 5 3 0 m 3 V O L U M E LF CR
      5 8 . 3 0 0 m 3 / M V - F L O W LF CR
      7 6 2 7 . 1 1 7 K G M A S S LF CR
      3 4 4 . 4 6 0 K G / M M - F L O W LF CR
      2 3 0 . 0 0 0 D E G C T E M P LF CR
      1 . 2 6 0 M P A P R E S S LF CR
      0 . 1 7 4 m 3 / K G S P - V O L LF CR
      2 8 8 6 . 7 6 0 K J / K G S P - E N T LF CR
LF CR
```

The following message to an instrument, requests the current values for the default rate and total:

```
: A 0 0 1 : R V D ? LF CR
```

The instrument response would be similar to the following:

```
A 0 0 1 2 0 0 2 / 0 3 / 1 4 1 8 : 2 5 : 0 0 0 0 LF CR
      1 2 6 . 4 5 5 m 3 V O L U M E LF CR
      2 0 . 4 3 7 m 3 / M V - F L O W LF CR
LF CR
```

Log Request

The log request asks the instrument how many logs will be included in a printed log report. These are the values described in [Time Settings and Data Logging](#) on page 45.

Command	Description
:RLR?	Return the number of log records (non-timebased logging)

Log Response Example

The following message asks the instrument with address 001 to return the number of log records that the instrument stores:

```
: A 0 0 1 : R L R ? LF CR
```

The instrument response would be similar to the following:

```
A 0 0 1 2 0 0 2 / 0 3 / 1 4 1 8 : 2 5 : 0 0 0 0 LF CR
2 4 LF CR
LF CR
```

Clear Data Request

The clear data request asks the instrument to clear the data in the selected registers.

Command	Description
:RCN?	Clear the non-accumulated (resettable) totals
:RCA?	Clear the accumulated totals
:RCL?	Clear the logs except for the “last edited” log

Clear Data Request Example

The following message asks the instrument with address 001 to clear the logged data that the instrument stores:

```
: A 0 0 1 : R C L ? LF CR
```

The instrument response would be similar to the following:

```
A 0 0 1 2 0 0 2 / 0 3 / 1 4 1 8 : 2 5 : 0 0 0 0 LF CR
LF CR
```

Instrument Information Request

The Instrument Information request asks the instrument to return the general information about the model and version codes. The instrument exception status is returned as a part of the header as it is with the header for all command responses.

Command	Description
:RIG?	Return the general information about the instrument such as Model number, Application number, Version and Serial numbers etc. These items are returned as a block in the same format as shown on the display in the “Model Info” menu.

Instrument Information Response Example

The following message asks the instrument with address 001 to return the general information about the instrument:

```
: A 0 0 1 : R I G ? LF CR
```

The following is an example of a hypothetical instrument response:

```
A 0 0 1   2 0 0 2 / 0 3 / 1 4   1 8 : 2 5 : 0 0   0 0 LF CR
5 1 5           M O D E L       - 1 - - F - LF CR
S C 0 1       I N P U T       F - T P - - LF CR
S C 0 1       V E R S       0 1 0 1 . 0 0 1 LF CR
C U S T O M   V E R S       0 0 0 0 0 1 LF CR
U N I T       S / N         1 2 3 4 5 6 LF CR
LF CR
| 1 | 2 | 3 | 4 | 5 | 6 | 7 | 8 | 9 |10|11|12|13|14|15|16|17|18|19|20|21|22|23|24|25|26|27|28|29|
```

Corrupted or Invalid Requests

If the instrument receives a corrupted or incomplete request, there is no response. The instrument discards any partial request and waits for the next enquiry.

If the instrument receives a request message in the correct format, but for a non-existent option, it returns only the message header. For example, if the instrument received the following request variables message :A001:RVT? it will return only the header because there is no T option for the ‘Variables Request’ message.

Modbus RTU Protocol

Modbus RTU (remote terminal unit) is an industry standard protocol that allows the instrument to be easily interfaced to other communication devices.

The instrument implements the Modbus protocol as detailed in the *Modicon Modbus Protocol Reference Guide* PI-MBUS-300 Rev J (June 1996).

Message Format

In RTU mode, messages start with a silent interval of at least 3.5 character times. The first field transmitted is the device address. Following the last transmitted character, a similar interval of at least 3.5 character times marks the end of the message. A new message can begin after this interval. The entire message frame must be transmitted as a continuous stream. A typical message frame is shown below:

Address	Function	Data	CRC Check
1 byte	1 byte	n bytes	2 bytes

Except for broadcast messages, when a master device sends a query to a slave device, it expects a normal response. One of four possible events can occur from the master's query:

- If the slave device receives the query without a communication error, and can handle the query normally, it returns a normal response.
- If the slave does not receive the query due to a communication error, no response is returned. The master program has to process a timeout condition for the query.
- If the slave receives the query, but detects a communications error (parity or CRC), no response is returned. The master program has to process a timeout condition for the query.
- If the slave receives the query without a communication error, but cannot handle it (for example, if the request is to read a nonexistent register), the slave will return an exception response informing the master of the nature of the error.

Instrument Address

The address of the instrument is programmable in the range from 1 to 247. Some addresses are reserved according to PI-MBUS-300 and have a special meaning:

- 0 = Broadcast, no response required from slave devices
- 248 to 255 Reserved

Function Codes

The instrument accepts the following function codes:

Code	Name	Description
03	Read data register(s)	Obtain the content of one or more 2-byte data registers.
06	Preset data register	Preset one 2-byte data register.
07	Read status register	Obtain the content of 1-byte status register.
16	Preset data register(s)	Preset one or more 2-byte data registers.

Exception Response

The instrument forms an exception response by adding 80H to the function code and using an exception code as the 1-byte data field in the returned frame. Implemented exception codes are as follows:

Code	Name	Description
01	Illegal function	The function code is not a legal action for the slave.
02	Illegal data address	The data address is not a legal address for the slave.
03	Illegal data value	The data value is not a legal value for the slave.
05	Acknowledge	The slave has accepted the request and is processing it, but a long duration of time will be required to do so.
06	Slave device busy	The slave is engaged in processing a long duration program command. The master should re-transmit the message later when the slave is free.

List of Data Registers

The following tables describe the addresses and meaning of the data registers in the instrument. The registers are grouped in blocks that relate to a particular function of the instrument. The data values are expressed in the engineering units that were selected for the variables when the instrument settings were configured.

Note: Conventional numbering of registers often starts from 1, therefore be aware that “register 1” in this case has “address 0” and so on.

The data registers represent different data types as specified in the tables:

- I - Integer, 2 bytes (Holding Register)
- L - Long Integer, 4 bytes (2 registers)
- P - Programmable Format, 4 bytes (2 registers)

The “Programmable Format” data type for 4-byte (2 registers) data values can be set as either Floating Point or Long Integer. The Floating Point variable is represented in IEEE-754 Floating Point 4-byte format and requires two 2-byte data registers:

IEEE-754	Modicon Registers
1st byte	low byte (register X)
2nd byte	high byte (register X)
3rd byte	low byte (register X+1)
4th byte	high byte (register X+1)

This means that two data registers must be read or written to obtain, or preset, one data value.

Current and Logged Process Data

This block of registers is available for the retrieval of current or logged process data with its matching time and date information.

Use the log type and log number to retrieve the logged information from the appropriate register. If a particular log number does not exist, or the instrument does not have the optional real-time clock, the time and date stamp and associated variables are set to zero.

Register	Name	Comments	Read Only or Read/Write	Data Type
1	Net Volume	Process Variables	R	P
3	Net Flowrate		R	P
5	Main Line Volume		R	P
7	Main Line Flowrate		R	P
9	Process Line Volume		R	P
11	Process Line Flowrate		R	P
13	Volumetric Ratio		R	P
15	Flowrate Ratio		R	P
17	Flowrate Deviation		R	P
19	Analog Input 1		R	P
21	Analog Input 2		R	P
23	Target Ratio		R	P
25	User Value		R	P
27	Batch ID Tag		R	L
29			R	P

Register	Name	Comments	Read Only or Read/Write	Data Type
31	Year	Current Date/Time or Logged Date/Time Stamp (see register 38 Log Number). Only current Date/Time can be edited	R/W	I
32	Month		R/W	I
33	Date		R/W	I
34	Hour		R/W	I
35	Minute		R/W	I
36	Second		R	I
37	Log Type	00 - hourly or log records 01 - daily 02 - weekly 03 - monthly 04 - yearly 05 - last edit of calibration 06 - current totals are non-accumulated values, register 38 is ignored.	R/W	I
38	Log Number	If set to 0, current variables and Date/Time are retrieved	R/W	I
39	Clear Data	01 - clear logs 02 - clear accumulated totals 03 - clear non-accumulated totals	W	I
40	Number of ID Tags		R	I

Instrument Exception Status

This register is available to verify the status of the instrument.

Register	Name	Comments	Read Only or Read/Write	Data Type
41	Exception Status	00 = no error 01 = analog input 1 failure 02 = analog input 2 failure 03 = analog input 3 failure 04 = analog input 4 failure 05 = invalid calibration parameter 06 = invalid reference parameter 07 = invalid property 08 to 09 reserved 10 = process parameters out of range 11 = input is over limit 12 = error detected: no flow 13 = error detected: overflow 14 = error detected: leakage 20 = system failure 21 = power supply is low 22 = new or failed clock battery 23 to 29 reserved 30 = alarm 1 active 31 = alarm 2 active 32 = alarm 3 active 33 = alarm 4 active	R	I

Instrument Control and I/O

This block of registers is available in some applications to give access to important information in the instrument.

Register	Name	Comments	Read Only or Read/Write	Data Type
42	Reserved			I
43	Logic Inputs	0 to 15 Binary representation of logic inputs 0 = activated; 1 = deactivated B0 = input 1 (LSB) B1 = input 2 B2 = input 3 B3 = input 4	R	I
44	Operation State	Representation of operation status 0 = Reset 1 = Maintenance 2 = Completed 3 = Waiting to restart 4 = Paused 5 = Waiting for timeout 6 = Running (Slow Start) 7 = Running (Prestop) 8 = Running (Full Flow)	R	I
45	Relay State	0 to 15 Binary representation of relay state 0 = open; 1 = closed B0 = relay 1 (LSB) B1 = relay 2 B2 = relay 3 B3 = relay 4	R	I
46	Relay Control	0 to 15 Binary representation of relay control 0 = open; 1 = close B0 = relay 1 (LSB) B1 = relay 2 B2 = relay 3 B3 = relay 4	R/W	I
47	Relay Control Source	0 to 15 Binary representation of relay control source 0 = Local - controlled by instrument operation 1 = RTU - controlled by Modbus register 46 B0 = relay 1 (LSB) B1 = relay 2 B2 = relay 3 B3 = relay 4	R/W	I
48	Delivery Number	Holds the delivery number (batch record) for a current or stored transaction (determined by Modbus register 38)	R	L
50	Control Mode	0 = Idle/Local Control from logic inputs 1 = Stop Stop delivery 2 = Run Start delivery 3 = Reset Clear totals	R/W	I
51 to 99	Instrument Parameters	See next table for details.	R/W	P

Register	Name	Comments	Read Only or Read/Write	Data Type
101	Analog Inp.1	Raw analog input data	R	P
103	Analog Inp.2	4-20mA inputs are read in Amperes	R	P
105	Analog Inp.3	0-5V or 1-5V inputs are read in Volts	R	P
107	Analog Inp.4	RTD inputs are read in degrees Kelvin	R	P
		Unused inputs are configured as 4-20mA		

Instrument Configuration Parameters

This block of registers is available in applications to give access to some important instrument parameters (i.e. target setpoint, etc).

The usage of these parameters can be dependent on other instrument settings. For full description, please refer to the 'Modbus Accessible Parameters' in [Parameters](#) on page 33.

Register	Name	Comments	Read Only or Read/Write	Data Type
51	Ratio Setpoint		R/W	P
53 to 99	Reserved		R/W	P

Valid Identification Tag Numbers

This block of registers is a list of the valid ID Tags that are authorised to start a delivery or batch. The security feature is only enabled if the ID-TAG protocol has been assigned to one of the communication ports. (A maximum of 100 ID Tag numbers can be stored in the instrument).

Register	Name	Comments	Read Only or Read/Write	Type
151	ID Tag 001		R/W	L
153	ID Tag 002		R/W	L
...	...		R/W	L
347	ID Tag 099		R/W	L
349	ID Tag 100		R/W	L

The highest nibble (4 bits) of each ID Tag value represents the blend % assigned to the ID Tag from a list of 16 options as follows:

0000 - 0%	0100 - 15%	1000 - 40%	1100 - 75%
0001 - 5%	0101 - 20%	1001 - 50%	1101 - 80%
0010 - 7%	0110 - 25%	1010 - 60%	1110 - 85%
0011 - 10%	0111 - 30%	1011 - 70%	1111 - 100%

iButton ID Tag Protocol

A protocol is available in this application that allows the instrument to communicate with an external “iButton LINK45” module. This allows the instrument to read identification tags to ensure that only authorised deliveries are made.

The LINK45 module provides a 1-Wire to RS232 interface with RJ45 connection to the read head and DB 9 female connection out. A null modem and DB 9 male to male gender changer is required to connect the LINK45 directly to the DB9 female RS232 port on the 515.

An interface kit (TK-RS232-KIT) can be supplied as an accessory, complete with LINK45 module, mini null modem gender changer, stainless steel panel mounting read head and cable.

If the RS232 port on the 515 is used for other communications, it is possible to connect the LINK45 module to the RS485 port via a serial RS232 to RS485 convertor.

The standard communication settings for the LINK45 module are 9600 baud, 8 bit, no parity and 1 stop bit.

If the ID-TAG protocol is not assigned to any 515 communication port the security identification feature will be disabled. When enabled the 515 instrument continually polls the LINK45 module checking for the presence of an ID Tag. For details on the operating procedure, refer to [ID Tag Validation](#) on page 24

Printer Protocol

A printer protocol is available in the 500 Series. It provides the ability to print out live data, individual logged data and to do some report-style printing of logged data. The method of printing these and the format of the printouts is described below.

Note: Printer output is only available if the Real Time Clock option is fitted.

The selection of Printer Protocol can be made for the Communications Protocol options for the RS232 or RS485 port. A list of log report types and printer types available at the end of the TM-LOG calibration menu.

Report Types

The list of report types is as follows:

- REP-10 Latest Logs Report

The number of logs printed in each report is determined by the value programmed for Report Logs in the TM-LOG menu.

Printer Types

The list of available printers is as follows:

- PRN-01 Generic computer printer
- PRN-02 Generic roll printer (printing first line first)
- PRN-03 Slip Printer TM295

Customizing a Printout

A customized printout can be provided which can have up to 4 header lines and 3 footer lines. It is also possible to include or exclude certain main menu items on the printout. If any customizing of the printout is required discuss this with the distributor.

Types of Printouts

Live Data

The RESET key, when in main menu, is shared as the PRINT key if the printer protocol has been selected. A printout will be initiated whenever this key is pressed. If printing is not required, do not select printer protocol.

The format of this printout will be:

Custom Header Line 1
Custom Header Line 2
Custom Header Line 3
Custom Header Line 4

Current Docket No.

Instrument Serial No. & Tag

Current Date & Time & Status
Variable unit value
Variable unit value
etc.

Custom Footer Line 1
Custom Footer Line 2
Custom Footer Line 3

----- <separation line>

(Note that blank header and footer lines are not printed).

Docket Number

The docket number that appears on the live data printout indicates the print number. This number is cleared when the Accumulated totals are reset. If the Reset Mode is set for Delayed, where a print can be generated without resetting the non-accumulated totals, an additional number in brackets will be shown that indicates the number of prints since the last reset. i.e.

DOCKET No. 000256 (000036)

Instrument Serial Number and Unit Tag

The instrument serial number and unit tag is the same as the information shown in the Model Info menu. For more details refer to [Model Information](#) on page 21

Individual Log Data

When in the Log Menu and while holding the DISPLAY key to view the data of the log of interest the RESET key can be pressed to initiate a printout of that log entry. The printout will have the time and date stamp corresponding to when the log was taken. After the print has been initiated there will be the opportunity to scroll to view another log entry and print again.

Since each log entry stores the delivery totals only, the printout will not have any accumulated totals. The format of the printout with this exception is the same as the LIVE DATA printout:

Custom Footer Lines

----- <separation line>

Reports such as “Latest Logs” will print in the historical order, and for those logs that have no data (e.g. unit was powered off at the time) the print will show “Data not available”. i.e.

Delivery No. Date & Time & Status

Variable unit value
Variable unit value
etc.

----- <separation line>

Del No. Data Not Available

----- <separation line>

Delivery No. Date & Time & Status

Variable unit value
Variable unit value
etc.

If the unit is programmed for 0 logs for the latest log reports then the report will only consist of the header and ID information and a “Data Not Available” message.

Custom Header Lines

Title of Report

Current Date & Time
Instrument Serial No. & Tag

Data Not Available

Custom Footer Lines

----- <separation line>

Printer Data Control

Some printers have limited data buffers and are therefore unable to collect all the print data being transmitted. The 500 Series has the capability of software handshaking. The Xon/Xoff characters can be used by any of the printer types to control the flow of data to ensure that data is not lost.

Some printers will also transmit an Xoff character in response to other events such as the printer being off-line, the print head not engaged or the power being removed. The specific behaviour of the printer being used should be noted.

Error Messages

There are two printer error messages that can be displayed.

PAPER OUT

This message is related to the Printer Type PRN-03 TM295 Slip printer. It is standard procedure with this printer to check for paper status before printing. If a print is attempted but there is no paper the PAPER OUT message will be scrolled. The instrument will continue to poll the printer for paper and if paper is detected before a communications timeout expires the print will commence.

COMMS TIMEOUT

This message is relevant for all printer types and will be activated for the following conditions.

1. If the flow of data is stopped due to software or hardware handshaking and is not allowed to resume before the communications timeout.
2. If Printer Type is PRN-03 Slip printer and a paper status is requested but no response is received within the timeout period.
3. Paper Out has been detected for Printer Type PRN-03 but no paper is inserted within the timeout period.

When a communications timeout error has been activated the message COMMS TIMEOUT will be scrolled once, the request to print will be cleared and the instrument will return to its normal mode.

Appendix A

Glossary

ASCII	American Standard Code for Information Interchange. For the ASCII protocol, the instrument receives and transmits messages in ASCII, with all command strings to the instrument terminated by a carriage return. Replies from the instrument are terminated with a line-feed and a carriage-return.
IrDA	The Infra-red Developers Association is a group of computer and software manufactures who have agreed on a format for communication among infrared devices.
K-factor	The K-factor is a constant value associated with frequency type flowmeters. It is a scaling factor used in calculations to determine volumetric flow rate.
Modbus RTU	The Modbus protocol is a message structure for communications between controllers and devices regardless of the type of network. In RTU (remote terminal unit) mode, each 8-bit byte in a message contains two 4-bit hexadecimal characters. This mode has greater character density than ASCII and allows better data throughput than ASCII for the same baud rate.
Normalised Input	A normalised input ranges from 0 to 1.000. For 4-20mA input, the signal is set to 0 at 4mA and the signal is set to 1.000 at 20mA.
NPS	Namur Proximity Switch.
Passive Output Signal	Requires an external power supply.

Appendix B

Model Numbers

Product Codes

Model	Supplementary Code	Description
515	- CB02	
Enclosure	1	Panel mount enclosure
	2	Field mount enclosure (not yet available)
	3/5	Explosion proof Ex410 with metric glands (5 specifies heater version)
	4/6	Explosion proof Ex410 with NPT glands (6 specifies heater version)
Output Options	0	N/A 4 logic inputs, 1 isolated output, 2 relays (only relay type 1 is available), RS232 (DB9) communication port
	1	4 logic inputs, 2 isolated outputs, 4 relays, real-time clock data logging, RS232 (DB9) and RS485 communication ports
	2/3	4 logic inputs, 2 isolated outputs, 4 relays, real-time clock data logging, RS232 (DB9) and Ethernet/RF communication ports (not yet available)
Relay Type	1	Electromechanical relays only
	2	2 electromechanical and 2 solid state relays
	3	Solid state relays only (not yet available)
Power Supply	E	For 220/240 VAC
	A	For 110/120 VAC
	D	For DC power only 12-28VDC
Display Panel Options	F	Fully optioned (with backlight, LCD backup and Infra-Red comms port)
PCB Protection	C	Conformal coating - required for maximum environmental operating range. Recommended to avoid damage from moisture and corrosion.
	N	None - suitable for IEC standard 654-1 Climatic Conditions up to Class B2 (Heated and/or cooled enclosed locations)
Application Pack Number	CB02	Defines the application software to be loaded into the instrument
For example: Model No. 515.112EFC Displayed on the 500 Series as:(only h/w that affects the operation is represented)		- 12 - F - 515 MODEL

Note: Example full product part number is 515.112EFC-CB02 (This is the number used for placing orders).

Custom Version Codes

	Code		Description
Origin Code Identifies Distributor	00		Factory Default Application
	01		Contrec Pty. Ltd. Melbourne Australia
	02		Contrec Pty. Ltd. Sydney Australia
	03		Contrec Europe Ltd. West Yorkshire UK
	04		Contrec - USA, LLC. Pelham AL 35124 USA
	05		Flowquip Ltd. Halifax UK
	06		
	etc.		
User Language	0		English (Default)
	1		German
	2		Dutch
	3		French
	4		Spanish
	5		
	etc.		
Distributor's Code	000		Distributor's own choice. Possibly a code that identifies the customer and the application.
	...		
	999		
For example: 02 3 157 Displayed on the 500 Series as:			023 157 CUSTOM VERS

Application Information Code

The Application Information code is an aid for users and service personnel to determine the type of inputs that are used in a particular application. The Application Information code is displayed on the instrument as shown below.

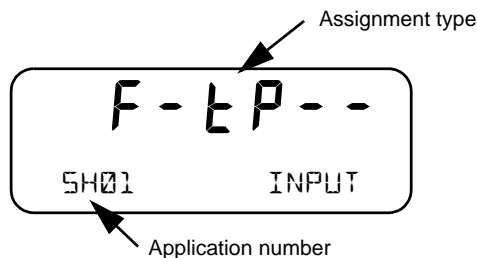

The Application Information code is returned as part of a General Instrument request (as described in [Instrument Information Request](#) on page 60).

The Application number identifies the application as in the following examples:

- SC01 - steam flow computer for frequency flow meter
- GN02 - natural gas flow computer for analog flow meter

The Input Assignment type indicates the physical input that is assigned to each input on the instrument. The code is made up from six characters as follows:

FINP1	FINP2	AINP1	AINP2	AINP3	AINP4
X	X	X	X	X	X

The codes are as follows:

- - - not used in this application
- *A* - indicates a generic analog input such as for density or level
- *d* - indicates a density input
- *F* - indicates a generic flow input such as for volume or mass, (frequency or analog)
- *H* - indicates a high flow input for stacked inputs
- *L* - indicates a low flow input for stacked inputs
- *P* - indicates a pressure input
- *Q* - indicates a quadrature input
- *t* - indicates a temperature input.

For example, *F - t P - -* is an instrument with FINP1 (frequency input 1) assigned to a flow input, AINP1 assigned to a temperature input and AINP2 assigned as a pressure input. The other inputs are not used.

Appendix C

Units of Measurement

Available Units of Measurement

The following is a list of the available units of measurement used across the range of 500 Series applications.

Units Type	Available units of measurement
Volume	m ³ , Km ³ , Ltr, Gal, KGal, MGal, ft ³ , kft ³ , Mft ³ , bbl
Volume Flowrate	m ³ /s, m ³ /min, m ³ /h, m ³ /D, L/s, L/min, L/h, Gal/s, Gal/min, Gal/h, KGal/D, MGal/D, ft ³ /s, ft ³ /min, ft ³ /h, Mft ³ /D, bbl/s, bbl/min, bbl/h, bbl/D
Volume K-Factor	P/m ³ , P/Ltr, P/Gal, P/ft ³ , P/bbl
Mass	kg, g, Ton, lb, Klb
Mass Flowrate	kg/s, kg/min, kg/h, g/s, g/min, g/h, Ton/min, Ton/h, Ton/D, lb/s, lb/min, lb/h, Klb/min, Klb/h, Klb/D
Mass K-Factor	P/kg, P/g, P/Ton, P/lb, P/Klb
Energy	kJ, MJ, GJ, kWh, MWh, kBTU, Ton.h, therm, cal, kcal, Mcal
Power	kJ/h, MJ/h, GJ/h, kW, MW, kBT/M, kBT/h, Ton, therm/min, therm/h, kcal/h, Mcal/h
Energy K-Factor	P/kJ, P/kWh, P/kBTU, P/Ton.h, P/therm, P/kcal
Temperature	Deg K, Deg C, Deg F, Deg R
Pressure	Pa, kg/m ² , kg/cm ² , kPa, MPa, mbar, bar, psi, Atm, inH ₂ O, mmH ₂ O
Density	kg/m ³ , kg/Ltr, lb/ft ³ , SG60F
Specific Volume	m ³ /kg, L/kg, ft ³ /lb
Specific Enthalpy	kJ/kg, BT/lb, cal/g, cal/kg, kcal/kg, Mcal/kg
Reynolds Number	E+0, E+3, E+6 (scaling for unitless variable)
Length (Level)	m, mm, cm, INCH, FOOT
Velocity	m/s, m/M, m/h, ft/s, ft/M, ft/h
Length K-Factor	P/m, P/cm, P/INCH, P/FOOT
Area	m ² , ft ²
Ratio	%
General Input	Pressure, Temperature, Density, Length (Level), Factor, Volume

Index

Numerics

- 0-5V input 10
- 4-20mA
 - input 10
 - output 13

A

- ACCUM key 18
- address, instrument 56
- alarm
 - connection 14
 - delay 43
 - equipment failure 41
 - hysteresis 43
 - relays 41
 - setpoint 42
- alarms menu 41
- analog input
 - connections 10
 - failure 51
 - scaling 2
- application code 76
- approvals 4
- ASCII protocol 55

B

- back panel 8
- battery
 - failed 51
 - life 45
 - new 51
- baud rate 44

C

- calibration
 - menu 30
 - set mode 28
 - view mode 27
- clock
 - battery 45
 - date format 46
 - real-time 45

codes

- application information 76
 - customer version 76
 - exception 64
 - product number 75
- ## communication
- connections 15
 - protocols 55
- ## communications 3, 53
- menu 43
- ## connections
- alarm 14
 - communication 53
 - communications 15
 - electrical 8
 - input 9
 - output 12
- ## customer version codes 76
- ## customizing a printout 68

D

- data log
 - viewing 20
- date format 46
- default total 17
- default variable 17
- delay, alarm 43
- display
 - specifications 5
 - timeout mode 47
 - timeout time 47
- DISPLAY key 18
- display-only parameter 27

E

- earthing 16
- electrical connections 8
- equipment failure alarm 41
- error condition, override 51
- error messages 51
- exception codes 64
- Exception Status 57

F

- failure of input 51
- features 1
- flash driver port assignment 45
- format, date 46
- frequency input connection 9
- front panel
 - infra-red port 16
 - keys 18
 - lamps 18

G

- glossary 73

H

- hardware connections 53
- hysteresis, alarm 43

I

- ID Tag
 - protocol 67
- ID tag
 - Modbus access 66
- infra-red port 16, 43, 54
- input
 - 0-5V 10
 - 4-20mA 10
 - connections 9
 - analog 10
 - frequency 9
 - failure 51
 - RTD 11
 - sensor failure 51
- inputs menu 34
- installation 7
- instrument
 - address 56
 - request format 56
 - responses 57
 - settings 32
- interconnections, communication 53
- interference suppression 15
- isolated outputs 3

K

- key
 - ACCUM 18
 - DISPLAY 18
 - RATE 18
 - RESET 18
 - SET 20
 - TOTAL 18
- keys, front panel 18

L

- lamps, status 18
- logged data 20
 - viewing 20
- logic input connection 12

M

- main menu items 18
- main menu, simplified 19
- menu
 - alarms 41
 - calibration 30
 - comms 43
 - inputs 34
 - outputs 39
 - params 33
 - setup 47
 - test 49
 - tm/log 45
 - units 32
- messages
 - error 51
 - prompts 52
 - system 50
 - warning 52
- Modbus accessible parameters 34
- Modbus data format 44
- Modbus RTU protocol 61
- mode
 - display timeout 47
 - normal operation 17
 - set calibration 28
 - view calibration 27
- model numbers 75
- mounting 7

N

- normal mode 17

number
 model 75
 serial 22

O

operation, normal mode 17

output
 connections 12
 4-20mA 13
 pulse 13
 pulse factor 40

outputs menu 39

override error condition 51

P

panel
 lamps 18
 mounting 7
 rear 8

parameter
 display-only 27
 not visible 27
 password-protected 27
 programmable 27

parameters menu 33

parity bits 44

password-protected parameter 27

peak flowrates 19, 20

port
 assignment, flash driver 45
 flash driver assignment 45
 infra-red 16, 43, 54
 RS-232 15, 43, 53
 RS-485 16, 43, 54

power supply interruption 45

printer
 data control 71
 error messages 72
 protocol 68
 report types 68

printer types 68

printouts
 individual logs 69
 live data 68
 log report 70
 types 68

product number codes 75

programmable parameters 27

prompts 52

protocol
 ASCII 55
 communication 55
 ID Tag 67
 Modbus RTU 61
 printer 68

pulse factor, output 40

pulse output 13

R

RATE key 18

real-time clock 45

rear panel 8

relay outputs 3

relays, alarm 41

RESET key 18

responses, instrument 57

RS-232 port 15, 43, 53

RS-485 port 16, 43, 54

RTD input 11

RTU protocol 61

S

safety & security 24

scaling analog input 2

serial number 22

SET key 20

setpoint, alarm 42

settings
 instrument 32

setup menu 47

shielding 16

snubber 15

specifications 5

standards 4

status lamps 18

stop bits 44

suppression, interference 15

system
 errors 51
 messages 50
 prompts 52
 warnings 52

T

terminal designations 8

test menu 49

timeout
 mode 47
 time 47
tm/log menu 45
TOTAL key 18
total, default 17

U

unit tag 22
units
 menu 32
User value 20

V

variable, default 17
version, customer 76
view data logs 20

W

warnings 52