

**LEVEL MONITOR
MODEL 220**



CONTENTS

1. Introduction	1
1.1 Model Number Designation	2
1.2 Intrinsic Safety Approvals	3
2. Specification	4
3. Operation	6
3.1 Display	6
3.1.1 Level Bar Graph	6
3.1.2 Contents	7
3.2 Front Panel Operation	8
3.2.1 Displaying Data	8
3.2.2 Changing Data	11
3.2.3 Timeout Condition	12
3.3 Test Mode	12
3.4 Alarms	13
3.4.1 Types of Alarms	14
3.4.2 Alarm Deadband	15
3.4.3 Alarm Action	15
3.4.4 Setting Alarms	17
3.5 Non-Linearity	18
3.6 Filtering	22
3.7 Density Correction	24
4. Programming	26
4.1 Program Steps	27
5. Signal Input	30
6. Alarm Outputs	31

7. Installation	33
7.1 Wall Mounting	33
7.2 Panel Mount Version	34
7.3 Removing the Front Panel	35
7.4 The Main Electronics	37
7.5 Wiring	38
7.6 Maintenance	38
7.7 Terminal Designations	39
8. Intrinsic Safety Connections	40
9. Instrument Disposal	42
Index	44

1. INTRODUCTION

The Model 220i Level Monitor is a microprocessor based instrument which accepts a 4-20mA input and displays level and contents. It is powered entirely from the 4-20mA loop and, therefore, does not require an external power source.

Level is displayed in a bar graph as 0...100%. The contents are a 7 digit numeric display which can be spanned in any engineering units.

The instrument is fully programmable; the user can program alarm settings, span & zero levels and non-linear correction points. Calculation constants are also set from the front panel and are stored in a non-volatile memory which retains data indefinitely.

The Model 220i Rate Totaliser conforms to the EMC-Directive of the Council of European Communities 2004/108/EC, the LVD directive 2006/95/EC and the following standards:

EN61326:2013 Electrical equipment for measurement, control and laboratory use – EMC requirements : Residential, Commercial & Light Industry Environment & Industrial Environment.

EN61010:2010 Safety requirements for electrical equipment for measurement, control, and laboratory use.

In order to comply with these standards, the wiring instructions in Section 7.5 must be adhered to.

2 Introduction

1.1 MODEL NUMBER DESIGNATION

The Model Number of the 220i describes the input and output options installed and the mounting options.

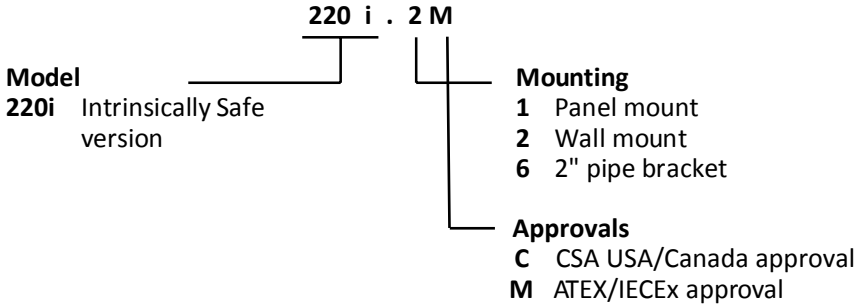

Tank Conversion Software
220CSW

1.2 INTRINSIC SAFETY APPROVALS

The Model 220i is certified for use in hazardous areas and has IECEx, ATEX and CSA *us/c* approvals.

The Model 220i certification details are:

IECEx Approval Rating	IECEx BVS 15.0099X Ex ia IIB T4 Gb
ATEX Approval Rating	BVS 15 ATEX E 106 X II 2G EX ia IIB T4 Gb
Ambient Temperature:	Ambient temperature of -20° to +60°C.
CSA <i>us/c</i> Approval Type:	LR 104 840-5. Class 1, Groups C and D.

When installing in hazardous areas, the instrument will have to be installed according to the guidelines given in Section 9 and in accordance with standards for wiring and installation in hazardous areas.

4-20mA Input

The input can be connected to IS circuits with the following maximum values:

$$U_i = 28V$$

$$I_i = 93mA$$

$$P_i = 653mW$$

Relay Outputs

The outputs can be connected to IS circuits with the following maximum values:

$$U_i = 28V$$

$$I_i = 93mA$$

$$P_i = 653mW$$

2. SPECIFICATION

General

Display:	Continuously powered LCD.
Level:	30mm bar graph.
Level Span:	0...100% per full scale.
Contents:	7 digit with 4½ digit resolution, 12mm (0.5") high.
Contents Span:	The units of measure (eg. litres) at full scale of input signal. The contents span is programmable in the range of 0.000...9,999,999.
Volume:	Either "Volume" or "Contents" can be displayed. This is user programmable.
Decimal Points:	Decimal point positions for contents is programmable in range of 0...3 decimal points.
Signal Type:	4-20mA.

4-20mA

Resolution and Linearity:	0.05% of span.
Accuracy:	0.05% of span @ 25°C. 0.1% (typically) of span full temperature range.
Update Time:	0.5 second.
Connection:	2 wire.
Voltage Drop:	2.5V maximum.

Outputs

Type:	4 open collector output alarms suitable for driving dc solenoids or external relays. The outputs provide: 1. high-high. 2. high. 3. low. 4. low-low.
Switching Power:	200mA. 30Vdc maximum.
Saturation Voltage:	0.8Vdc across the output in the "on" state.
Isolation:	All outputs are separately opto-isolated.

Physical

Operating Temperature:	-20°C to 60°C.
Dimensions:	97mm (3.8") high x 150mm (5.9") wide x 41mm (1.6") deep (not including cable glands).
Protection:	Nema 4X or IP67 standards.
Cable Entry:	Cable glands.
Mounting:	Universal mounting bracket is supplied as standard.
Pipe Mounting:	A galvanised metal bracket is available which enables the instrument to be mounted on a 2"horizontal or vertical pipe.

3. OPERATION

The Model 220i Level Monitor accepts a 4-20mA input signal from a level sensor such as a pressure transmitter, ultrasonic sensor or capacitance probe. The instrument is powered entirely from the loop and, therefore, requires no external power or internal batteries.

The instrument is fully programmable with all operating parameters and calculation constants programmable from the front panel (see Section 4.1). The setup parameters are stored in a non-volatile memory and are retained for at least 10 years in the event of a power loss.

3.1 DISPLAY

The display of the Model 220i comprises of:

Level Bar Graph
Contents

3.1.1 Level Bar Graph

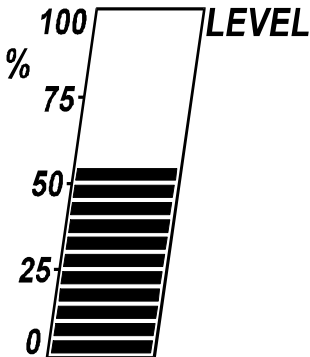

The level bar graph displays the vertical level of liquid as a percentage.

Inputs of 4mA and 20mA can be programmed to correspond to 0% and 100% respectively, or can be inverted so that 4mA will correspond to 100% and 20mA will correspond to 0%.

Note that the level is corrected for density (if applicable) as described in Section 3.7.

3.1.2 Contents

The contents is a 7 digit numeric display where the span can be programmed during setup to read in any engineering units. The contents are displayed with 4½ resolution in respect to the maximum contents.

For example, if the maximum contents is 1234567, the display will show up to 5 digits plus trailing zeros. At different inputs the following will be displayed:

1234567 will be displayed as 1234500; 234567 will be displayed as 2345000.

However, if the first digit is greater than 1, then up to 4 digits only will be displayed with trailing zeros. For example, if the maximum contents is 2345678, then at different inputs:

2345678 will be displayed as 2345000; 345678 will be displayed as 345000.

CALCULATION OF CONTENTS

For a **linear tank** the contents is calculated as follows:

$$\text{Contents} = (\text{Span}) \times (\% \text{ Level}) + \text{Offset}$$

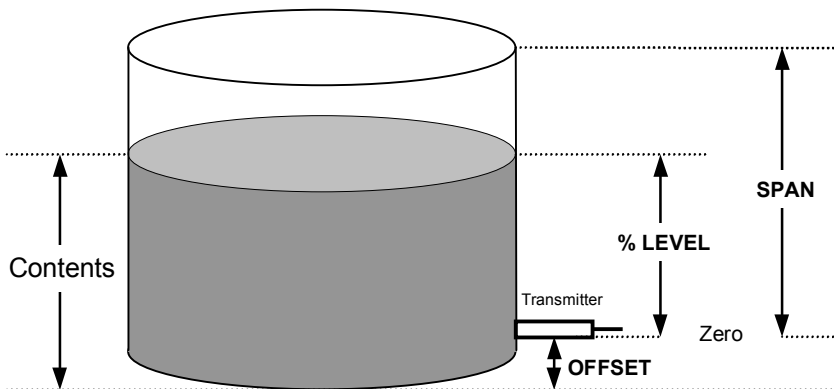

8 Operation

3.2 FRONT PANEL OPERATION

3.2.1 Displaying Data

The alarm setpoints and density correction factor can be viewed by pressing the DISPLAY key.

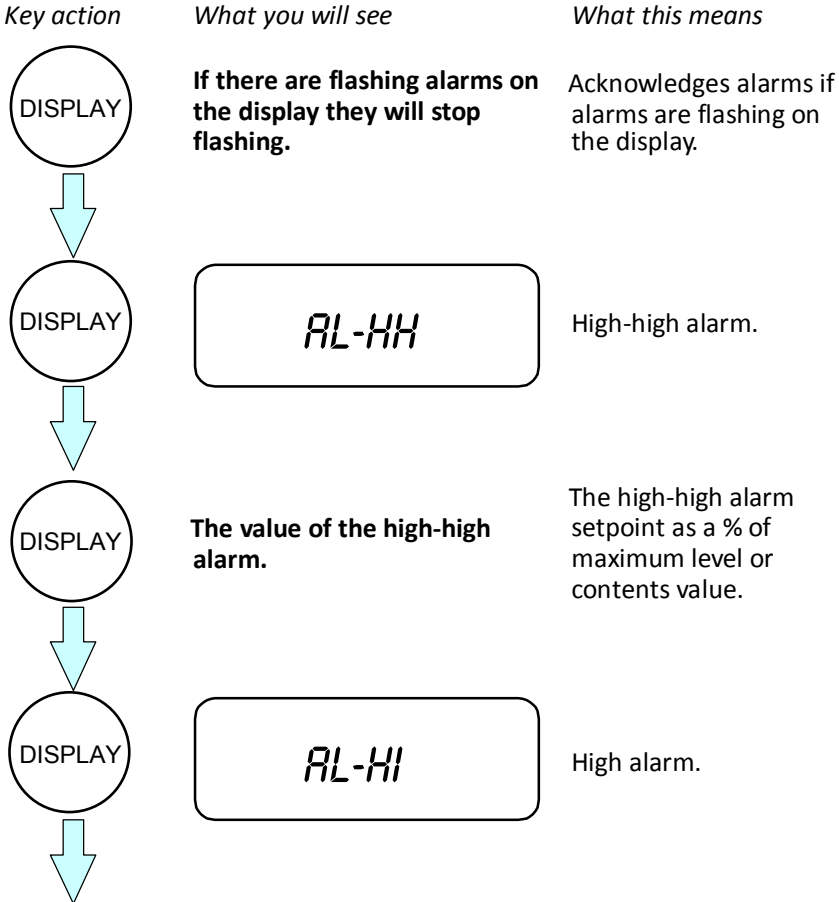

Key action

What you will see

What this

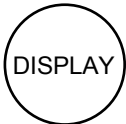

The value of the high alarm.

The high alarm setpoint as a % of maximum level or contents value.

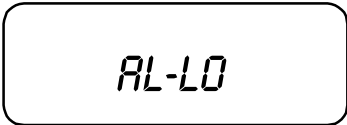
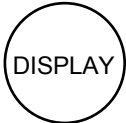

Low alarm.

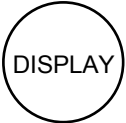

The value of the low alarm.

The low alarm setpoint as a % of maximum level of contents value.

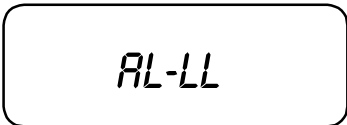
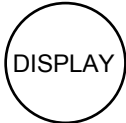

Low-low alarm.

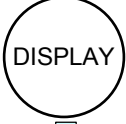

The value of the low-low alarm.

The low alarm setpoint as a % of maximum level or contents value.



10 Operation

Key action

What you will see

What this

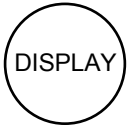

Density correction

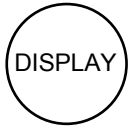

The value of the density correction factor.

A factor for those applications where the density of the fluid in the tank is likely to change (default of 1.000).

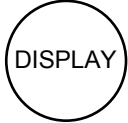

Returns to contents display.

3.2.2 Changing Data

Each of the above parameters can be changed as follows:

1. Pressing the DISPLAY key consecutively until the numeric value of the parameter to be changed appears (as described in the previous diagram).
2. This value can then be changed using the following keys:





This key steps from digit to digit, causing the digit to flash. Only flashing digits can be changed.



This key increments the flashing digit.

Example.

To change the high alarm setpoint to 75:

1. Press DISPLAY until the value of the high alarm appears. This will be the value after AL-HI.
2. The first digit is flashing, this means it can be changed. Using the  key, this digit is changed to 7.
3. The  key is pressed so that the second digit flashes.
4. Using the  key, this digit is changed to 5.

Note that the Model 220i can be programmed so that the above parameters cannot be changed, see Section 4.1.



12 Operation

3.2.3 Timeout Condition

Upon entering the display mode, if no key is pressed for 10 seconds, the display returns to the contents display with alarm acknowledgment cleared.

3.3 TEST MODE

The 220i has a test mode which can be entered by simultaneously pressing all 3 front panel keys. There are 3 tests:

<i>Low Test</i>	By pressing the  key, the low and low-low alarms outputs will be energised.
<i>High Test</i>	By pressing the  key, the high and high-high alarm outputs will be energised.
<i>Display Test</i>	By pressing the DISPLAY key, all segments of the display will flash.

To exit the test mode all three keys are pressed simultaneously.

3.4 ALARMS

The Model 220i has 4 alarm outputs:

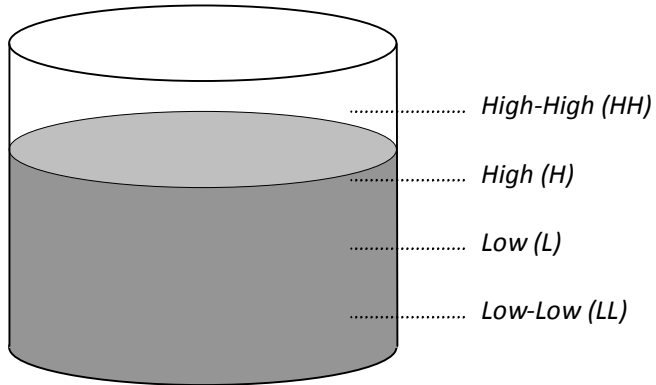

The alarms can be assigned to **level** or **contents** which is done during programming (see Section 4.1). Each alarm is individually programmed as a percentage (0-100%) of level or contents.

All of the alarms have open collector outputs and are separately isolated via opto-isolators. The outputs are internally protected against voltage spikes caused by relays and coils.

14 Operation

3.4.1 Types of Alarms

3.4.1.1 Alarm Output

The Model 220i can be programmed for the alarm outputs to operate in one of two ways:

1. the alarm outputs can **energise** (switch on) during an alarm condition, or
2. the alarm outputs can **de-energise** (switch off) during an alarm condition.

3.4.1.2 High Alarms

The high alarms will be activated when the contents or level in the tank increase above the high alarm setpoints. These alarms will be deactivated when the contents or level falls below these programmed setpoints.

When setting the alarms, the high-high alarm should be set higher than the high alarm.

3.4.1.3 Low Alarms

The low alarms will be activated when the level or contents in the tank falls below the low alarm setpoints. These alarms will be deactivated when the level exceeds the programmed setpoint.

Similarly, when setting the low alarms, the low-low alarm should be set below the low alarm.

3.4.2 Alarm Deadband

To prevent an alarm toggling on and off when the level is close to the setpoint, a user programmable deadband is provided. The deadband is a percentage (0-100%) of the maximum level or contents.

Example 1.

If the low alarm is set to 20% and the deadband is set to 5%, the alarm will be activated when the level reaches 20%. The alarm will then stay activated until the level increases above 25%.

Example 2.

If the high alarm and deadband are set at 80% and 5% respectively, the alarm will be activated at 80% and will stay activated until the level falls below 75%.

3.4.3 Alarm Action

When an alarm condition exists the Model 220i will act in the following way:

1. The appropriate alarm output will be activated.
2. The display will flash the name of the alarm.
3. In some cases these alarms may be acknowledged from the front panel.
This will depend on whether they are programmed as **continuous** or **acknowledgeable alarms**. This is set up during programming (see Section 4.1).

The differences between acknowledging continuous and acknowledgeable alarms are described in table on the following page.

16 Operation

Acknowledgeable Alarms	Continuous Alarms
1. These alarms are acknowledged by pressing the DISPLAY key.	1. A continuous alarm cannot be acknowledged.
2. Once the alarm is acknowledged the flashing on the LCD will cease, with the alarm message remaining solid. The message will remain on the screen until the alarm condition no longer exists.	2. The flashing on the LCD cannot be stopped and will keep flashing until the alarm condition no longer exists.
3. Once the alarm is acknowledged, the alarm output will be deactivated.	3. The alarms will only be deactivated when the level (or contents) is outside alarm conditions.
Note that acknowledging the LL alarm will also acknowledge (and deactivate) the L alarm. Similarly, acknowledging the HH alarm will also acknowledge (and deactivate) the H alarm.	

3.4.4 Setting Alarms

To set any of the alarms:

1. Press the DISPLAY key until the name of the alarm to be changed appears (see Section 3.2.1).
2. Use the \triangleright and \triangleleft keys to change the value of the alarm.
3. Press the DISPLAY key until the original level/contents screen appears.

3.5 NON-LINEARITY

The Model 220i can be programmed to correct for the non-linearities in irregular shaped tanks. These tanks have a non-linear relationship between the height of liquid and the volume of liquid.

A correction table, which corrects for non-linearities between the level signal and the volume, can be programmed during setup. This table works as follows:

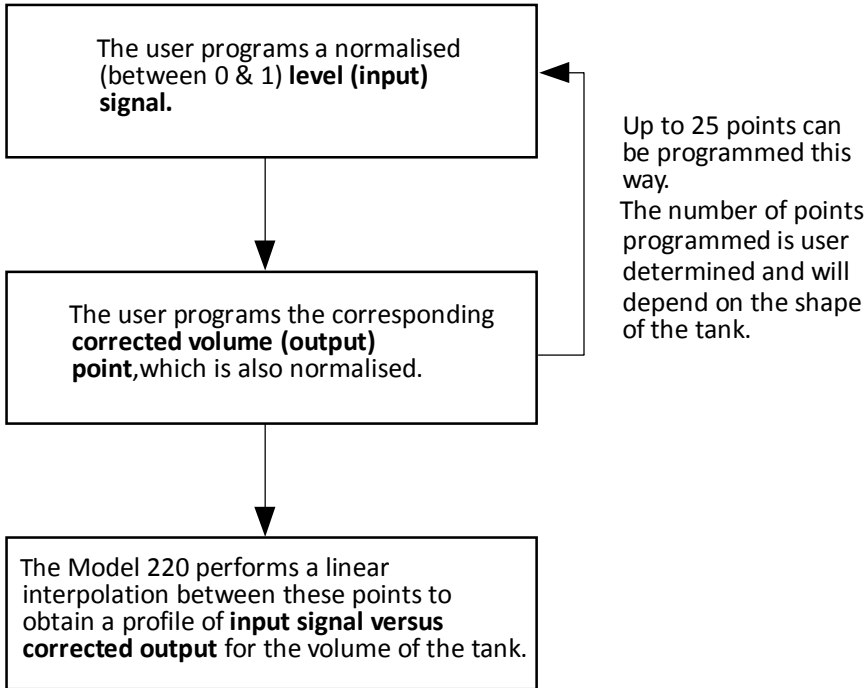

DETERMINING THE NON-LINEAR CORRECTION TABLE

Data on tank non-linearity is usually supplied by the tank manufacturer, in the form of strapping tables. If this data is not available, the user will need to determine the relationship between level and volume. This can be done mathematically by equations, or experimentally, by conducting physical measurements.

In either case, the data must be normalised. An example of this is shown below:

Example.

A spherical tank has a diameter of 10m. The zero is at 0.5m and the span is 10m. The following 15 point relationship has been determined:

	Input		Volume	Normalised Inputs for Table	
	Level (m)	Level T'mitter Output	m ³	Input	Output
	0.5	4mA	3.796	0.000	0.000
1	1.094		17.421	0.0630	0.026
2	1.688		39.699	0.125	0.069
3	2.281		69.314	0.188	0.126
4	2.875		104.951	0.250	0.195
5	3.469		145.295	0.313	0.272
6	4.063		189.031	0.375	0.356
7	4.656		234.844	0.438	0.444
8	5.250		281.418	0.500	0.534
9	5.844		327.438	0.563	0.623
10	6.438		371.590	0.625	0.708
11	7.031		412.557	0.688	0.786
12	7.625		449.025	0.750	0.857
13	8.219		479.678	0.813	0.916
14	8.813		503.202	0.875	0.961
15	9.406		518.280	0.938	0.990
	10.000	20mA	523.599	1.000	1.000

20 Operation

Where,

$$\begin{aligned} \text{Normalised Input} &= \frac{\text{Level}}{\text{Level at 20mA}} \\ &= \frac{\text{Level} - (\text{Level at Zero})}{(\text{Level at Span}) - (\text{Level at Zero})} \end{aligned}$$

If the Zero is >0

So, for example, at 9.406m the normalised input is:

$$\begin{aligned} &= \frac{(9.406 - 0.5)}{10 - 0.5} \\ &= 0.938 \end{aligned}$$

Similarly,

$$\begin{aligned} \text{Normalised Output} &= \frac{\text{Volume}}{\text{Volume at 20mA}} \\ &= \frac{\text{Volume} - (\text{Volume at Zero})}{(\text{Volume at Span}) - (\text{Volume at Zero})} \end{aligned}$$

If the Zero is >0

So, for example, at 9.406m the volume is 518.280m³ and the normalised output is:

$$\begin{aligned} &= \frac{(518.280 - 3.796)}{(523.599 - 3.796)} \\ &= 0.990 \end{aligned}$$

SELECTING THE NUMBER OF POINTS FOR NON-LINEAR CORRECTION

The user can program up to 25 points. However, the values at 4mA or 20mA which are set at 0 and 1 respectively, are not programmed. It is not always necessary to program all 25 points, as it will depend on the shape of the tank.

Tank Conversion Software

Tank Conversion Software 220CSW can be used to calculate theoretical non-linearity correction tables for the most commonly used tank shapes (spherical, conical and cylindrical tanks).

The output from the program can be printed and is in a format suitable for direct programming into the Model 220i. The program runs on a Windows 95 (or higher) operating system.

The software is only available from our website **www.contrec.co.uk** and can be downloaded free of charge.

3.6 FILTERING

Input fluctuations caused by tank agitation can interfere with the stability of the level and contents readings. For this reason, the Model 220i has a digital filter which will average out these fluctuations and enable accurate readings.

The degree of filtering of the input signal can be adjusted, depending on the amount of fluctuation and the particular application. Values from 1 to 99 can be programmed, where 1 corresponds to no filtering and 99 corresponds to heavy filtering. Such flexibility in filtering means that highly accurate and stable readings can be obtained.

When programming the degree of filtering, it is advisable to start with no filtering (the factor equals 1) and gradually increase until a steady reading is obtained. It is important that the filtering is not too heavy because this will cause an over damped response.

The following graph shows the time to reach 90% and 99% of a new reading for a step change in input signal.

**Filter Factor vs Time to Reach New Reading
(for a step change in input signal)**

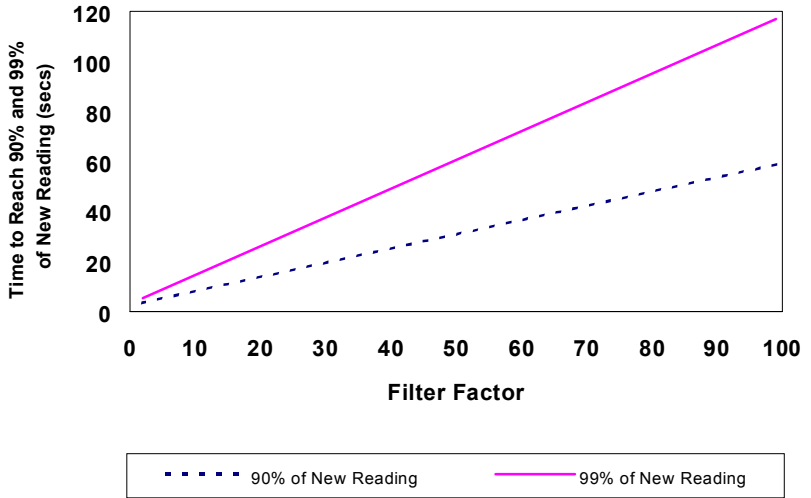

3.7 DENSITY CORRECTION

In some cases, a pressure transmitter will be used to provide the 4-20mA signal to the Model 220i. In these cases, a density correction factor (K_D) can be manually entered to compensate for those applications where the density of the fluid in the tank is likely to change. This would be the case if, initially, a particular fluid is stored in the tank and at a later stage a fluid of a different density is stored in the tank.

The density correction factor should initially be set to 1.000 when the Model 220i is calibrated for a given tank or vessel. If, at a later stage, a fluid of different density is stored in the tank, then it is only necessary to reprogram the density correction factor, rather than conducting a complete recalibration of the Model 220i.

The density correction factor is the **ratio** of the density of the fluid which was originally in the tank, to the density of the new fluid.

This can be expressed as follows:

$$\text{Density Correction Factor } (K_D) = \frac{\text{Density Value at Calibration}}{\text{New Density Value}}$$

The density correction factor is then used to calculate level as:

$$\text{Level} = K_D \times \text{Input Signal}$$

where the input is normalised between 0% (4mA or 20mA if inverted) and 100% (20mA or 4mA).

The level is limited to 100% so that values of K_D which result in a level greater than this will be displayed as 100%.

Example.

A tank is initially filled with toluene, which has a density at standard conditions of 866 kg/m^3 . The Model 220i and a level transmitter are calibrated for the volume in this tank and the density correction factor (K_D) is set to 1.000.

At a later date, the tank is filled with acetone, whose density at standard conditions is 791 kg/m^3 .

The density correction factor is calculated as follows:

$$K_D = \frac{866}{791} = 1.1$$

This value of K_D is then programmed during setup (see Section 3.2.2).

4. PROGRAMMING

The Model 220i is fully programmable with all parameters being stored in memory.

To enter the Program Mode:

Remove the lower cover strip (the dark grey strip along the bottom of the front of the enclosure) and replace it the reverse side up. This brings a small magnet on the inside of the cover strip in contact with a reed switch inside the instrument. The word "Set" is then displayed.

To exit Program Mode:

The grey strip should be replaced the correct way up.

The key switch actions are as follows:



This key steps from digit to digit, causing the digit to flash.



This key will increment a flashing digit or change a parameter selection.

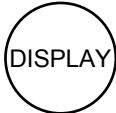

This key will step through the program sequence.

In stepping through the program sequence (using the DISPLAY key), the parameter description is displayed first, followed by the actual value or parameter. When a value or parameter can be changed it is shown as flashing.

4.1 PROGRAM STEPS

<i>Step</i>	<i>Display</i>	<i>Description</i>
1	SET	Select whether alarms are assigned to level or contents .
	Level	Alarms are assigned to level.
	Cont	Alarms are assigned to contents.
2	TYPE	Select whether alarms are normally energised or normally de-energised .
	NE	Normally energised.
	ND	Normally de-energised.
3	ACT	Select type of alarm action, either continuous on alarm condition or Cancels when alarm is acknowledged.
	N-AC	Continuous on alarm condition.
	AC	Acknowledged and cancelled with display key.
4	DBAND	Alarm deadband.
	xx.xx	Program alarm deadband as a % of maximum level or contents value.
5	FILT	The filter constant for filtering the input signal.
	1	No filtering.
	to	
	99	Very heavy filtering.

28 Programming

<i>Step</i>	<i>Display</i>	<i>Description</i>
6	INPUT	Select input type; either inverted or non-inverted .
	N-INV	Non-inverted (zero at 4mA).
	INV	Inverted (zero at 20mA).
7	DISP	Select enable or disable . This will allow (enable) or not allow (disable) the user to change the alarm setpoints and the density correction factor from the DISPLAY key.
	En	Enable the changing of alarm setpoints and density correction factor.
	Dis	Disable changing alarm setpoints and density correction factor.
8	UNIT	Select whether the word "Contents" or "Volume" is displayed on the LCD.
	Cont	"Contents" will be displayed.
	Vol	The word "Volume" will be displayed in preference to Contents. (Note there is no difference in operation if Volume is selected.)
9	C-DEC	The position of the decimal point for the contents. The user can select 0, 1, 2, or 3 decimal places.
10	C-SPAN	Span of the contents. The span can be programmed in the range of 0.000 to 9,999,999.

<i>Step</i>	<i>Display</i>	<i>Description</i>
11	C-00	The zero of the contents. The zero can be programmed in the range of 0.000 to 9,999,999.
12	LIN	Select whether the input signal is linear or non-linear .
	N-lin	Linear. Non-linear.
<i>Steps 13-17 are displayed only if the input signal is non-linear.</i>		
13	No-PTS	The number of points for non-linear correction. The user can program up to 25 points. Note the user does not program the values at 4mA or 20mA, which are set at 0 and 1 respectively.
14	INP-01	Non-linear correction Input Point #01. The input point for the first non-linear correction point is programmed in the range of 0.000 to 0.999. Input points must be programmed in ascending order.
15	OUT-01	The corresponding Output Point #01 for non-linear correction is programmed in the range of 0.000 to 0.999.
16	INP-XXX	Non-linear correction Input Point #XX. Subsequent input points are programmed in the range of 0.000 to 0.999.
17	OUT-XXX	The corresponding Output Point #XX. The corresponding output points are programmed.
18	SOFT	The software version used in the Model 220i is displayed.

5. SIGNAL INPUT

The signal input is on terminals 3 and 4 and is connected as follows:

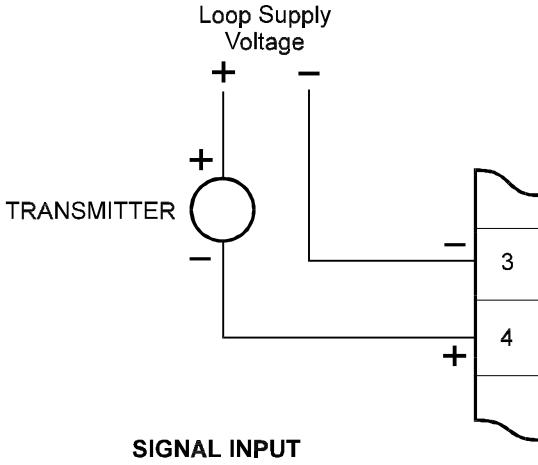

6. ALARM OUTPUTS

Open collector outputs are provided for high and low level alarms. The output can sink up to 200mA and can be used to power external relays, lights or audible alarms. The outputs are internally protected against voltage spikes.

Both outputs are separately isolated via opto-isolators.

Alarm Output Specifications

Maximum Current (sink):	200mA.
Maximum Voltage:	30Vdc.
Saturation Voltage:	0.8Vdc across outputs in energised state.
Isolation:	All outputs are separately isolated via opto-isolators.

32 Alarm Outputs

Connections

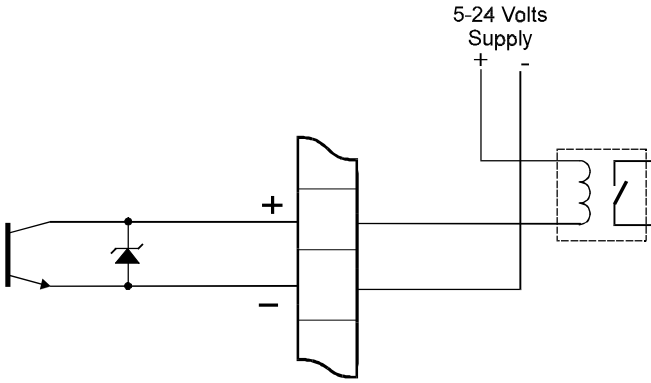

ALARM RELAY

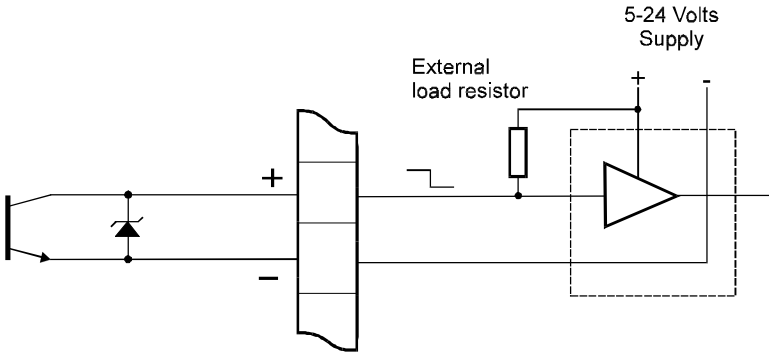

ALARM OUTPUT TO EXTERNAL CIRCUIT

7. INSTALLATION

7.1 WALL MOUNTING

A wall mounting bracket is supplied with each instrument. Round head screws should be used to attach the bracket to the wall (countersunk screws should not be used). The bracket is mounted first, with the tray section at the bottom. The instrument is then mounted on the bracket with two screws as shown below.

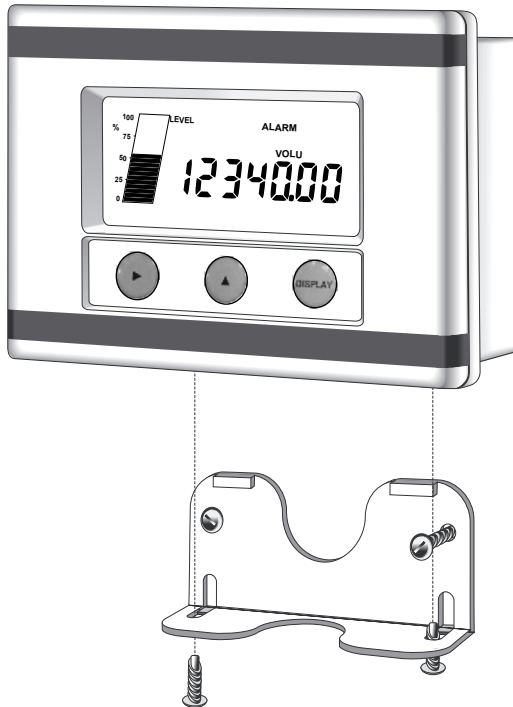

7.2 PANEL MOUNT VERSION

The panel mount version of the Model 220i is supplied with two panel mount brackets and plug-in terminals, which are accessible from the rear of the instrument.

A diagram of the rear panel is shown below:

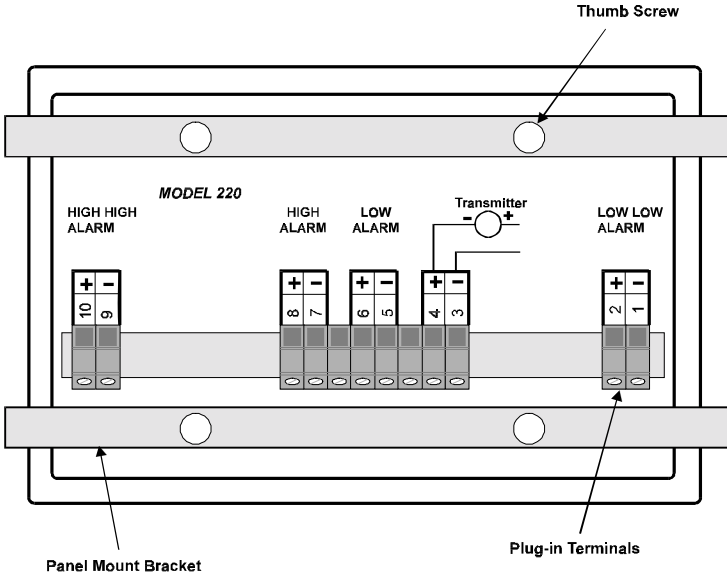

The cutout for this version is 141mm (5.55") wide x 87mm (3.43") high.

7.3 REMOVING THE FRONT PANEL

The front panel should be removed as follows:

1. Remove the top and bottom cover strips (ie. the dark plastic strip) by levering a screwdriver under one end.
2. Undo the screws retaining the front. Do not remove the screws, they are retained by O-rings.
3. Remove the front panel from the housing.

To replace the front cover, follow the above procedure in reverse. Ensure that the front panel is aligned at connector points before tightening the screws.

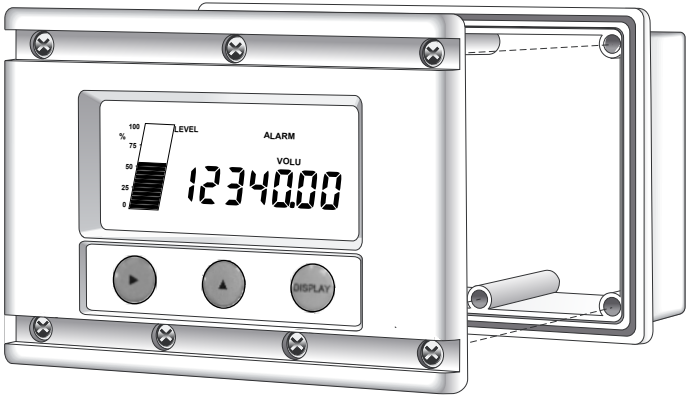
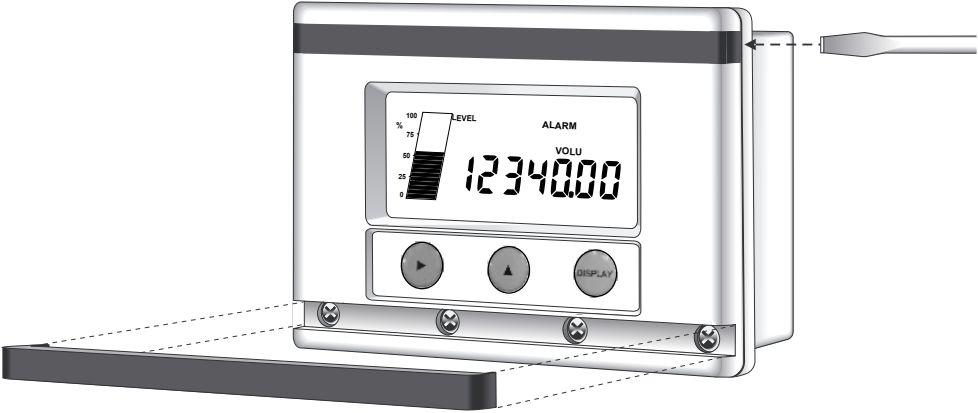

7.4 THE MAIN ELECTRONICS

The front section of the housing contains the microprocessor and display. It is possible to adjust the display contrast via a small potentiometer on the board. The display contrast is shown below and this can be adjusted for optimum contrast.

Adjacent to this control is a reset switch, which can be used to reset the microprocessor. Note that pressing this button will reset all setup parameters.

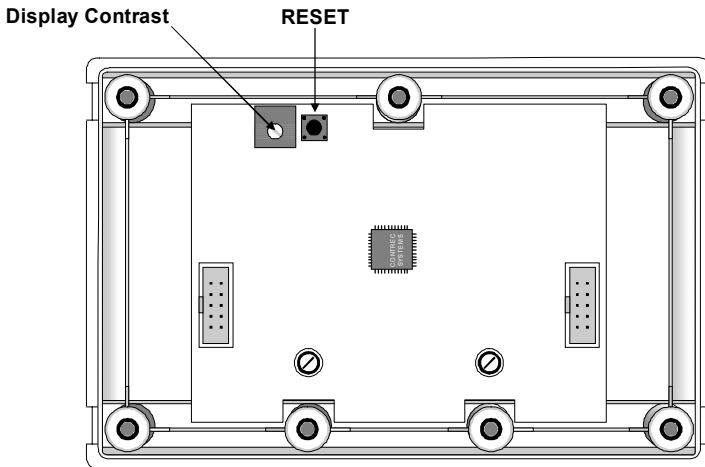

38 Installation

7.5 WIRING

When connecting the Model 220i, it is good practice to use shielded cable. The shield should be connected to earth at one end of the cable. The other end of the shield should not be connected.

This wiring practice is mandatory in order to comply with the requirements for Electromagnetic Compatibility as per EMC-Directive 2004/108/EC of the Council of the European Community.

7.6 MAINTENANCE

All printed circuit boards must be repaired by Contrec Ltd. In the case of a fault, no attempt should be made to repair the board as the intrinsically safe functionality may be impaired.

SPECIAL CONDITIONS FOR SAFE USE

To comply with this products ATEX/IECEx certification the special conditions for safe use must be followed.

The Instrument type 220i shall be mounted in an area where electrostatic charge/discharge will be avoided.

7.7 TERMINAL DESIGNATIONS

4-20mA Input

3	4-20mA (-)
4	4-20mA (+)

Outputs

1	Low-low Alarm (-)
2	Low-low Alarm (+)
5	Low Alarm (-)
6	Low Alarm (+)
7	High Alarm (-)
8	High Alarm (+)
10	High-high Alarm (-)
11	High-high Alarm (+)

8. INTRINSIC SAFETY CONNECTIONS

When installing the Model 220i in hazardous areas, the wiring and installation must comply with appropriate installation standards.

The approval uses entity parameters and an associated apparatus type approval on the input/output connections to the 4-20mA current loop and alarms. The 4-20mA input and alarm outputs must, therefore, only be connected as shown on the following page to barriers with the specified parameters.

The Model 220i will connect directly to a 4-20mA current loop and alarms, provided they do not exceed the following input parameters:

$$U_i = 28V$$

$$I_i = 93mA$$

$$P_i = 653mW$$

The internal capacitance seen on the input (terminals 3-4) is 0.02uF while the internal capacitance seen on the output (terminals 1-2, 5-6, 7-8 and 10-11) is 0.1uF maximum. Inductance is negligibly small on both the input and output.

Outputs

The four open collector outputs must only be connected to certified IS equipment via barriers as shown on the following page. Only certified intrinsically safe solenoids may be used for IS applications.

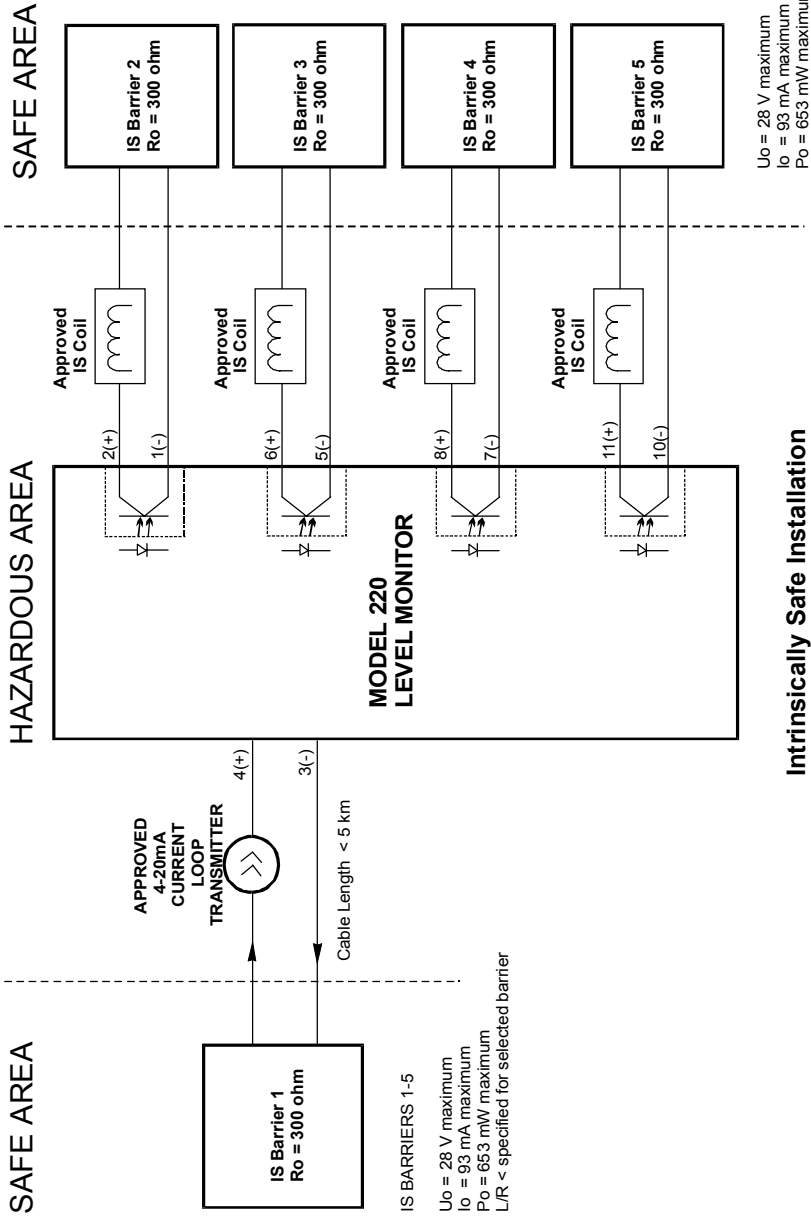

Intrinsically Safe Installation

8. INSTRUMENT DISPOSAL

Contrec instrumentation should not be thrown into the general waste system.



If within EU member states, this instrument should be disposed of according to the guidelines set by the WEEE (Waste Electrical and Electronic Equipment) directive 2012/19/EU. If outside of the EU, this equipment should be responsibly disposed of according to local and national regulations for EEE (Electrical and Electronic Equipment).

By not discarding of this product along with other house hold waste you are preserving natural resources and reducing waste sent to landfill and incinerators.

PAGE INTENTIONALLY LEFT BLANK

Index

4½ Resolution, 7

A

Alarms, 13
Acknowledgeable
 Alarms, 15
Alarm Deadband, 15
Alarm Outputs, 30

C

Calculation of
 Contents, 7
Contents, 7
Continuous, 15

D

Density Correction
 Factor, 24

E

Electronics, 36

F

Filtering
 Filter Factor, 22
Front Panel Operation,
8

H

Hazardous, 3
High Alarms, 14

I

Installation, 32
Intrinsic Safety, 3, 44
Instrument Disposal,
42

L

Level Bar Graph, 6
Low Alarms, 14

M

Microprocessor, 36
Model Number, 2

N

Non-Linearity, 18
Normalised, 19

O

Open Collector
 Outputs, 30

P

Panel Mount, 33
Programming, 25

R

Relay & Power
 Module, 39

S

Signal Input, 29

Span
 Offset, 7
Standards, 1

T

Tank Conversion
 Software, 21
Terminal
 Designations,
 38
Test Mode, 12
Timeout, 12

W

Wall Mounting, 32
Wiring, 37