

**FIELD MOUNTED
RATE TOTALISER
MODEL 202A**



CONTENTS

Safety Notice	1
1. Introduction	2
1.1 Model Number Versions	3
1.2 Intrinsic Safety Approvals	4
2. Specification	6
3. Programming	8
3.1 Operation	9
3.2 Program Steps	10
3.3 Calculation of Rate and Total	13
3.4 Total Conversion	15
3.5 Filtering	16
3.6 Example	18
4. Signal Input	19
5. Alarm & Pulse Outputs	20
6. Intrinsic Safety Connections	22
7. Installation	24
7.1 Wiring	24
7.2 Maintenance	24
7.3 General	24
7.4 The Main Electronics	25
7.5 Grounding	25
7.6 Wall Mounting	26
7.7 Front Panel	27
7.8 Panel Mount	29
7.9 Dimensions	30
7.10 Terminal Designations	31
8. Instrument Disposal	32
Index	34

SAFETY NOTICES

Only competent persons with the applicable training and authorisation should work in potentially explosive atmospheres.

When this instrument is used in hazardous area, all wiring must be energy limited according to the documentation provided and the marking label attached to the instrument.

The safety of any system that incorporates Contrec 200 series instruments is the sole responsibility of the system assembler/installer.

This manual must have been fully read and understood before the installation and commissioning of any system using this instrument.

The instrument should only be operated if installed and maintained correctly

To ensure correct and safe operation of this instrument after installation and maintenance the instrument should be fully sealed via the front screws and gland entries.



SPECIAL CONDITIONS FOR SAFE USE

To comply with this products ATEX/IECEx/CSA certification the specialconditions for safe use must be followed.

The Instrument type 202Ai shall be mounted in an area where electrostatic charge/discharge will be avoided.

1. INTRODUCTION

The Model 202Ai Rate-Totaliser is a microprocessor based instrument designed to measure a 4-20mA signal from flowmeters and pressure transducers. The

instrument can be programmed to display directly in engineering units and includes features such as linear or square law calculation, integration and digital filtering.

Rate, Total and Accumulated Total can be displayed in engineering units on the large LCD display. A front panel switch selects the function for display and a Reset button allows the Total to be reset to zero.

The instrument is fully programmable, with all calculation constants set via the front panel switches and stored in a non-volatile memory which will retain data indefinitely. The user can program span, filtering levels, display resolution and cutoff point.

The instrument is powered from a 4-20mA input signal and therefore, requires no external power.

The Model 202Ai Rate Totaliser conforms to the EMC-Directive of the Council of European Communities 2014/30/EU, the LVD directive 2014/35/EU and the following standards:

EN61326:2013 Electrical equipment for measurement, control and laboratory use – EMC requirements : Residential, Commercial & Light Industry Environment & Industrial Environment.

EN61010:2010 Safety requirements for electrical equipment for measurement, control, and laboratory use.

In order to comply with these standards, the wiring instructions in Section 7.5 must be followed.

3 Introduction

1.1 MODEL NUMBER VERSIONS

The Model Number describes the options available for the 202Ai as follows:

Model 202Ai.X0X.X

The first X denotes the mounting options and will be replaced by one of the following numbers:

- 0** No holes drilled for cable entry
- 1** Panel mount
- 2** Wall mount (standard)
- 6** for Pipe mounting

The Wall mount instrument is supplied with cable glands that are watertight and have integral strain relief.

The second X denotes approval Versions:

- C** CSA USA / Canada Approval
- M** ATEX/IECEX Approval

The third X denotes enclosure Type*:

- A** Aluminium
- S** Stainless Steel

Example part number **202Ai.20M.A**

*NOTE - As standard the enclosure type is plastic, unless specified with 'A' or 'S' as above.



**Model 202A
(Plastic Enclosure)**

1.2 INTRINSIC SAFETY APPROVALS

The Model 202Ai is certified for use in hazardous areas and has IECEx, ATEX and CSA US/C approvals.

The Model 202Ai certification details are:

IECEX Approval Rating	IECEX BVS 15.0099X Ex ia IIB T4 Gb
--------------------------	---------------------------------------

ATEX Approval Rating	BVS 15 ATEX E 106 X II 2G Ex ia IIB T4 Gb
-------------------------	--

Ambient Temperature:	Maximum ambient temperature of -20° to+60°C.
----------------------	--

CSA NRTL/C Approval Type:	70061366 Class 1, Groups C and D T4
------------------------------	--

When installing in hazardous areas, the instrument must be installed according to the guidelines in Section 2 and in accordance with the local relevant standards for wiring and installation in hazardous areas. Failure to do so may result in the protection provided by the equipment becoming impaired.

When bearing the CSA mark, the instrument must be powered supply unit with a limited energy circuit in accordance with CAN/CSA C22.2 No. 61010-1-12 and ANSI/UL 61010-1, or Class 2 as defined in the Canadian Electrical Code C22.1, Section 16-200 and/or National Electrical Code (NFPA 70), article 725.121.

5 Introduction

1.2.1 MAXIMUM INPUT VALUES

4-20mA Input

The input can be connected to IS circuits with the following maximum values:

$$U_i = 28V$$

$$I_i = 93mA$$

$$P_i = 653mW$$

Relay Outputs

The outputs can be connected to IS circuits with the following maximum values:

$$U_i = 28V$$

$$I_i = 93mA$$

$$P_i = 653mW$$

2. SPECIFICATION

General

Display:	LCD, which is continuously powered.
Resettable Total:	7 digits with 10mm (0.4") high digits. Resettable from front panel.
Accumulated Total:	Displayed when the Accumulated Total button is pressed.
Rate/Display:	4 digits with 8.5mm (0.33") high digits.
Span:	The units of measure per timebase (eg. gallons/sec) is programmable in the range 0.000001 to 999,999.
Decimal Points:	Decimal Point positions are fully programmable for both rate and total.
Timebase:	Span can be programmed in units per second, minute, hour or day.
Signal Type:	4-20mA.

4-20mA Input

Resolution and Linearity:	0.05% of span.
Accuracy:	0.05% of span @ 25°C. 0.1% (typ) of span, full temperature range.
Update Time:	0.5 seconds.
Connection:	Two wire.
Voltage Drop:	2.5 volts maximum.

7 Specification

Outputs

Type:	Two open collector outputs suitable for driving DC solenoids or external relays. The outputs provide high and low flow alarms or pulse output and low flow alarm.
Switching Power:	200mA. 30VDC maximum.
Saturation Voltage:	0.8VDC typical across the output in the "on" state.
Isolation:	Both outputs are separately opto-isolated.
Pulse Duration: (for pulse output)	If CAL00 = 1 (scaled pulse output): a. 1ms if output frequency > 50Hz, b. 10ms if output frequency is 5 ... 50Hz, c. 100ms if output frequency is < 5Hz.

Physical

Temperature:	Operating Temperature: -20°C to 60°C.
Dimensions:	98mm (3.9") high x 151mm (5.9") wide x 43mm (1.7") deep (cable glands not included).
Protection:	Sealed to Nema 4x or IP67 standards.
Cable Entry:	By cable glands.
Wall Mounting:	Universal Mounting Bracket supplied as standard.
Pipe Mounting:	A galvanised metal bracket is available which enables the Model 202A to be attached to a 2" vertical or horizontal pipe.
Panel Mounting:	Supplied with mounting brackets. Terminals accessible from rear. (Note that the panel mount version is not watertight.) Cutout: 141mm (5.6") wide x 87mm (3.4") high.
Max Weight:	Stainless Steel - 22200g, Aluminium 900g, Polycarbonate - 400g

Additional

Pollution Degree:	2
Over Voltage Category:	II
Maximum Altitude:	2000m above sea level

3. PROGRAMMING

The Model 202A is fully programmable, with all parameters being stored in non-volatile memory.

The Program Mode can be entered in one of two ways:

1. **Plastic Enclosure** - By removing the lower plastic cover strip (ie. the dark grey strip along the bottom of the enclosure) and replacing it the wrong side up. This brings a small magnet on the inside of the cover strip in contact with a reed switch inside the instrument.
2. **Metallic Enclosure** - By removing the metallic cover strip below the buttons. Unscrew the strip and replace the wrong side up. This brings a small magnet on the inside of the cover strip in contact with a reed switch inside the instrument.

The PROGRAM switch is used to step through the program (CAL sequences) and The and keys on the front panel are used to change and increment the flashing digits.

The CAL number is displayed on the lower display and the parameter is displayed on the upper display.

Parameters in Program Mode that consist of the two parts, **whole numbers** and **digits after the decimal point**, are restricted to having a maximum of 6 significant digits. Therefore the number of significant digits entered in the *whole numbers* determines the number of digits that are able to be entered in the *digits after the decimal point*.

For Example

000001 in the whole numbers makes 00000 available after the decimal place.

000100 in the whole numbers makes 000 available after the decimal place.

010000 in the whole numbers makes 0 available after the decimal place.

9 Programming

3.1 OPERATION

The Model 202A Rate Totaliser will display:

Rate
Resettable Total
Accumulated Total

Both the Rate and Resettable Total are continuously displayed while the Accumulated Total is only displayed when the ACCUM TOTAL key is pressed.

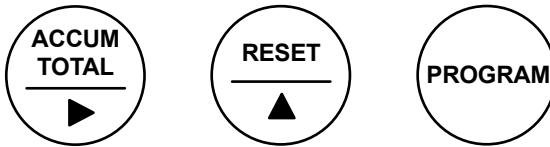

The Resettable Total can be reset at any time by pressing the RESET key.

The instrument also has a test mode which can be entered by simultaneously pressing all three front panel keys. The tests are as follows:

Lo Test By pressing the ACCUM TOTAL key, the low alarm output will go low.

Hi Test By pressing the RESET key, the high alarm output:
a. will go low if CAL00 = 0 (high alarm output),
b. will output 100ms pulses every 0.5sec if CAL00 = 1 (scaled pulse output).

Display Test By pressing the PROGRAM key, all segments of the display will show.

To exit the test mode, simultaneously press all three front panel keys.

Note that when the input signal drops below 3.75mA (4-20mA input), a signal error will occur. The display will alternate between the current total and the word "SIGNAL". When the input signal drops below ≈ 3.5 mA the Model 202A shuts down saving totals in the non-volatile memory.

3.2 PROGRAM STEPS

<i>Step</i>	<i>Comment</i>
CAL 00	<p>Pulse Output.</p> <p>0 = No pulse output, low and high alarms 1 = Scaled pulse output and low alarm</p>
CAL 01	<p>Span - whole numbers.</p>
CAL 02	<p>Span - digits after the decimal point.</p> <p>The Span is the number of units of measure per timebase (e.g. litres/sec, Gal/min). The Span can be programmed in the range of 0.000001 - 999,999.</p> <p>See section 3.2.</p>
CAL 03	<p>Cutoff Point.</p> <p>This determines the cutoff point as a fraction of Span. See section 3.2.2.</p>
CAL 04	<p>Decimal Point for Rate Display.</p> <p>The flowrate can be displayed with 0, 1, 2 or 3 decimal point places.</p>
CAL 05	<p>Timebase for Rate.</p> <p>The Rate can be displayed in units per second, minute, hour or day.</p> <p>0 = second 1 = minute 2 = hour 3 = day.</p>

See section 3.3

11 Programming

Step *Comment*

CAL 06 **Filter.**

Fluctuations in the flowrate can be filtered out so that the Rate is held steady. The filter value is programmed between 1 - 99 where "1" represents ***no filtering*** and 99 is maximum.

See section 3.4.

CAL 07 **Decimal Point for Total Display.**

The totals can be displayed with 0, 1, 2 or 3 decimal points.

CAL 08 **Total Conversion Factor - whole numbers.**

CAL 09 **Total Conversion Factor - digits after the decimal point.**

The Total Conversion Factor enables the Rate to be displayed in one engineering unit and the Totals to be displayed in another engineering unit. The Total Conversion Factor can be programmed in the range of 0.000001 - 999,999. Set to 1.000 if totals and rate are in the same unit eg. litres.

See section 3.3.

CAL 10 **Low Alarm - whole numbers.**

<i>Step</i>	<i>Comment</i>
CAL 11	Low Alarm - digits after the decimal point. CAL 10 & 11 program the flowrate below which the low alarm relay will close. The value can be programmed in the range 0 to 999,999.
CAL 12	High Alarm or Pulse Output Factor - whole numbers.
CAL 13	High Alarm or Pulse Output Factor - digits after the decimal point. CAL 12 & 13 program the flowrate above which the high alarm relay will close. The value can be programmed in the range 0 to 999,999. If the pulse output is selected (see CAL 00), the value will represent the total per pulse. eg. 5 litres per pulse.
CAL 14	Input Flow Relationship. 0 = Linear Input 1 = Square Root Input
CAL 15	Accumulated Total Reset. CAL 15 displays the accumulated total which can be reset by pressing and holding the RESET key for about 5 seconds.
SOFT	Software Version.

13 Programming

3.3 CALCULATION OF RATE AND TOTAL

3.3.1 Analog Input

The flowrate, R , is calculated as follows:

$$R = SA \quad \text{if the linear relationship is selected}$$

or
$$R = S \sqrt{A} \quad \text{if a square law relationship is selected}$$

where A = the input value

S = the span

At the minimum input (i.e. 4mA), $A = 0$, and at the maximum input (i.e. 20mA), $A = 1$.

The Span, S , can be set during calibration anywhere in the range of 0.000001 to 999,999.

The Span, S , is programmed in units of volume per timebase (ie. litres/minute or kilograms/hour). This also means that the Total will be displayed with the same unit of volume, ie. litres or kilograms.

3.3.2 The Cutoff Point

Because many transducers do not always exactly transmit 4mA when they are at zero rate, it is often necessary to define a rate below which no integration takes place. This is termed the cutoff point and is programmed as a percent age of the Span, S.

For example, if $S = 2200$ kg/min in a square law system, and the cutoff point is set at 20.0%, the actual cutoff rate R_c can be determined as follows:

The cutoff rate is defined as:

$$R_c = 2200 \sqrt{A}$$

At 20% cutoff,

$$\begin{aligned} R_c &= 2200 \times 0.2 \\ &= 440 \text{ kg/min} \end{aligned}$$

The value of A which would produce this cutoff is:

$$A = 0.04 \quad (\text{since } \sqrt{0.04} = 0.2)$$

and the input signal would be:

$$\begin{aligned} I &= 16mA \times 0.04 + 4mA \\ &= 4.64mA \end{aligned}$$

15 Programming

3.4 TOTAL CONVERSION

The Total Conversion feature enables the rate to be displayed in one engineering unit (e.g. gallons/minute) and the totals to be displayed in another engineering unit (e.g. barrels).

The Span is always programmed in the unit relating to *Rate*, and the Total Conversion constant is a division factor which can be used to convert the totals to the different unit. The Total Conversion factor affects the resettable and accumulated totals.

For Example.

If the Rate is required in gallons per minute:

1. The Span would be programmed as gallons per minute.
2. The timebase would be programmed as minutes.

If the Totals are required in barrels:

3. The Total Conversion factor is programmed as 42 (there are 42 gallons in a barrel). All totals will now totalise in barrels.

Some common units are given below together with the Total Conversion constant which should be programmed.

Rate*	Totals	TOTCON
<u>Gallons (US)/</u>	<u>Barrels (oil)</u>	<u>42.000</u>
Litres/	Kilolitres	1000
ml/	Litres	1000
Mgallons/	Acre-feet	0.32587

- * Units per second, minute, hour or day. The timebase is programmed separately during Programming.

3.5 FILTERING

Frequency fluctuations caused by pulsating flow through a flowmeter, often makes the Rate impossible to read with any precision.

The Model 202A has a digital filter which will average out these fluctuations and enable the Rate to be read to four digit accuracy. The ability to select a suitable filtering level means that highly accurate and stable readings can be obtained without excessive lag.

The diagram below shows a pulsating signal input together with the effect of filtering.

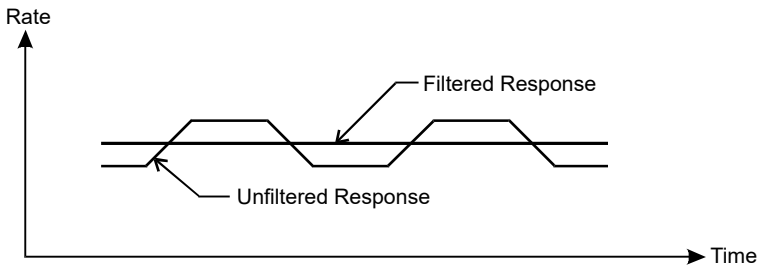

As a guideline to the degree of filtering to be used, the following table shows the response to a step change in input. The value, CAL 06, is the filter constant which is programmed during the Programming routine. The times for the display value to reach 90% and 99% of full swing are given in seconds, for different values of CAL 06.

17 Programming

A	90%	99%
1	0	0
2	1	2
4	2	4
6	3	6
10	5	11
15	8	17
20	11	22
25	14	28
35	20	40
45	25	51
60	34	69
75	43	86
90	52	103
99	57	113

Table 1 - Response to a step Input (in seconds).

Note that if CAL 06 is set to 01 there is no filtering of the input signal.

3.6 EXAMPLE

A vortex flowmeter has a maximum output of 20.538 litres/min at 20mA. It is required to display the flowrate in litres/min with 1 decimal point and the total in litres with no decimals. High and low alarms are required at 18 l/m and 2 l/m respectively. The instrument is then programmed as follows:

CAL00	0	No Pulse Output
CAL01	00020	Span (Whole Numbers)
CAL02	5380	Span (Decimals)
CAL03	0.05	Cutoff Point as a fraction of Span
CAL04	1	Rate decimal position
CAL05	1	Timebase
CAL06	01	Filter disabled
CAL07	0	Total decimal position
CAL08	0001	Total Conversion (set to 1.0000)
CAL09	0000	Total Conversion (decimals)
CAL10	00002	Low Alarm
CAL11	0000	Low Alarm
CAL12	00018	High Alarm
CAL13	0000	High Alarm
CAL14	0	Linear Input
CAL15		xxxx Accumulated Totals
SOFT	202A1.11	Software Version

4. SIGNAL INPUT

The signal input is on terminals 3 and 4 and can be connected as follows:

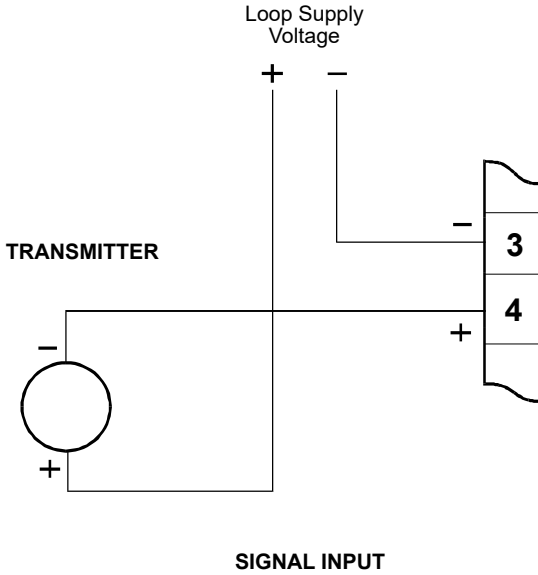

5. ALARM & PULSE OUTPUTS

Open collector outputs are provided for high and low flowrate alarms. The output can sink up to 200mA and can be used to power external relays, lights or audible alarms. The outputs are internally protected against voltage spikes caused by relays and coils.

Both outputs are separately isolated via opto isolators.

As an alternative to a high flowrate alarm, the output on terminals 7 and 8 can be programmed to output a scaled pulse output.

The switching points can be programmed during the setup mode and the low flow alarm will switch on whenever the flowrate drops below the programmed flowrate. Similarly, the high alarm switches on whenever the flow exceeds the high setpoint.

If a Scaled Pulse Output is programmed, a pulse will be output every preset value of the total. For example, if the total is in litres, then programming 5 will output one pulse every 5 litres. The duration of pulses is adjusted automatically to the output frequency.

Specification for Alarm Outputs

Maximum Current (sink):	200mA.
Maximum Voltage:	30VDC.
Saturation Voltage:	0.8VDC across Outputs when in the "on" state.
Isolation:	Both outputs are separately isolated.
Pulse Frequency:	500Hz maximum.
Pulse Duration:	1ms if output frequency > 50Hz. 10ms if output frequency = 5 ... 50Hz. 100ms if output frequency < 5Hz.

21 Alarm & Pulse Outputs

Connections

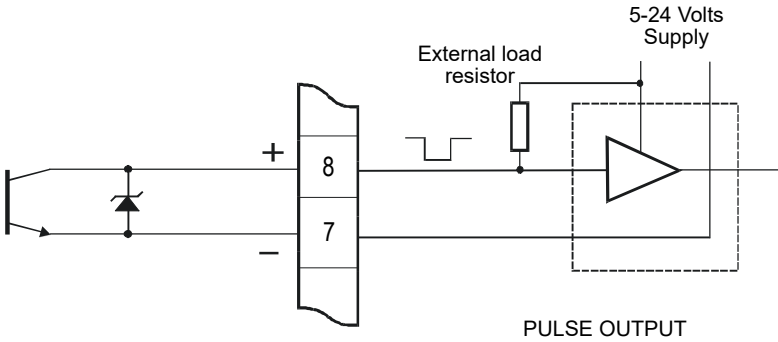
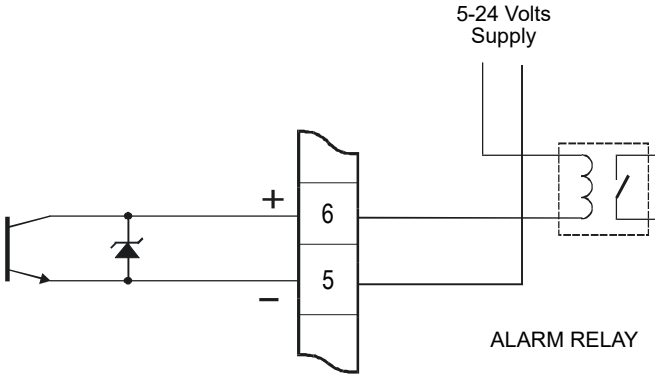

6. INTRINSIC SAFETY CONNECTIONS

When installing the Model 202Ai in hazardous areas, the wiring and installation must comply with appropriate installation standards.

The approval uses entity parameters and an associated apparatus type approval on the input/output connections to the 4-20mA current loop and alarms. The 4-20mA input and alarm outputs must, therefore, only be connected as shown on the following page, to barriers with the specified parameters.

The Model 202A will connect directly to a 4-20mA current loop and alarms, provided they do not exceed the following input parameters:

$$\begin{aligned}U_i &= 28V \\I_i &= 93mA \\P_i &= 653mW\end{aligned}$$

The internal capacitance seen on the input (terminals 3 & 4) is 0.02uF while the internal capacitance seen on the output (terminals 5-8) is 0.1uF maximum.

Inductance is negligibly small on both the input and output.

Outputs

The two open collector outputs must only be connected to certified IS equipment via barriers as shown on the following page. Only certified intrinsically safe solenoids may be used for IS applications.

SAFE AREA

HAZARDOUS AREA

SAFE AREA

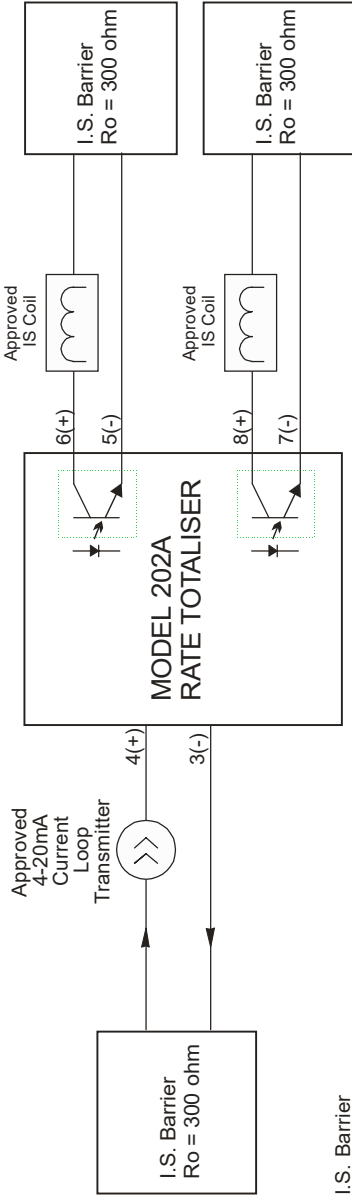

I.S. Barrier

$U_o = 28V$ maximum
 $I_o = 93 \text{ mA}$ maximum
 $P_o = 653 \text{ mW}$ maximum

I.S. Barrier

$U_o = 28V$ maximum
 $I_o = 93 \text{ mA}$ maximum
 $P_o = 653 \text{ mW}$ maximum

Intrinsically Safe installation

7. INSTALLATION

7.1 WIRING

All wiring must be undergone by a competent persons with the necessary training and comply to all national and local standards and legislation

Use wire with a minimum temperature rating of ≥ 65 Degrees Celsius

When connecting the 202A it is good practice to use shielded cable. The shield should be connected to earth at one end of the cable. The other end of the shield should not be connected.

This wiring practice is mandatory in order to comply with the requirements for Electromagnetic Compatibility as per EMC-Directive 2004/108/EC of the Council of the European Community.

7.2 MAINTENANCE

All printed circuit boards must be repaired by Contrec. In the case of a fault, no attempt should be made to repair the instrument as the intrinsically safe certification may be impaired.

For further details contact Contrec Ltd or Contrec representatives listed at the end of this manual.

All batteries for use in hazardous areas must be supplied by Contrec.

No substitute batteries are permitted as the battery packs contain certified energy limiting devices and insulation protection.

The inside of the instrument should remain clean and free of contaminants. After routine maintenance the instrument must be re sealed to ensure no ingress occurs

7.2.1 Cleaning

Clean with mild detergent or maximum 35% isopropyl solution

7.3 GENERAL

Ensure that all gland entries not used are blanked with IP rated gland plugs/blanking caps.

The instrument should be installed so that it is protected from impact and extreme weather conditions

Install in a way the minimises vibration

25 Installation

7.4 THE MAIN ELECTRONICS

The front section of the housing contains the microprocessor and display.

It is also possible to adjust the display contrast via a small potentiometer on the board. The DISPLAY CONTRAST control is shown below and this can be adjusted for optimum contrast.

Adjacent to this control is a RESET switch which can be used to reset the microprocessor. Note that pressing this button will Set all totals to zero and calibration parameters to default values.

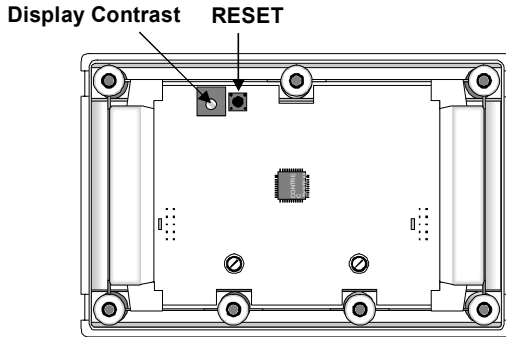

NOTE - Image shows plastic front panel

7.5 GROUNDING THE ENCLOSURE

NOTE. This only applies to the aluminium enclosure

On one side of the enclosure a ground point is available to attach the 202A to the nearest protective earth (PE).

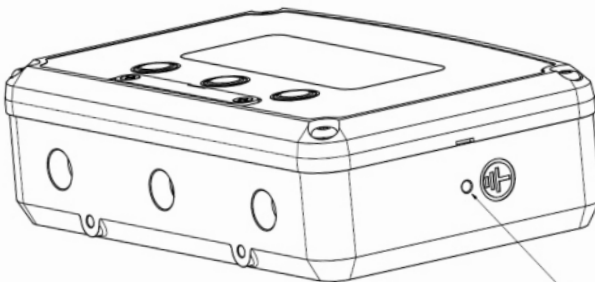

Earth Point

7.6 WALL MOUNTING

A wall mounting bracket is supplied with each instrument. The bracket should be attached to the wall using round head screws (do not use counter sunk screws).

The bracket is mounted with the "tray" section at the bottom. The instrument is then attached to the bracket at the bottom with two screws (see diagram below).

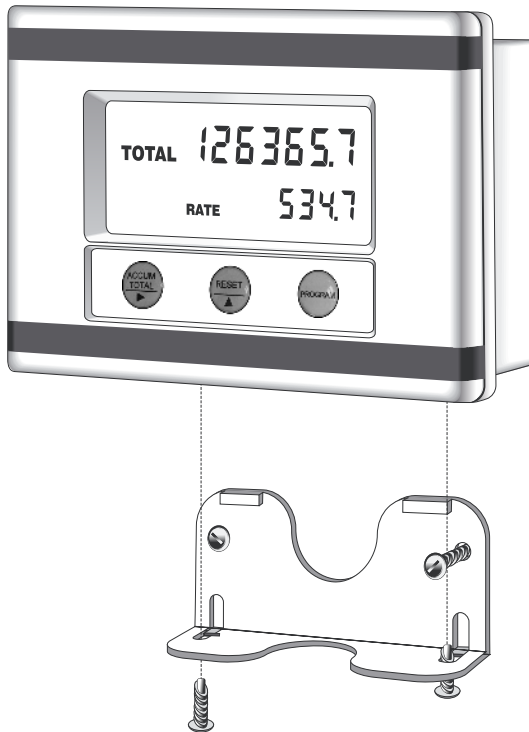

27 Installation

7.7 FRONT PANEL

7.7.1 Removing the front panel - Plastic enclosure

Only open the instrument in a clean, dry environment

The front of the instrument is removed as follows:

1. Remove both the top and bottom cover strips (i.e. the dark plastic strips on the front) by levering a screwdriver under one end.
2. Undo the seven screws retaining the front. *Note that the screws should not be removed from the front panel as they are retained by O-rings.*
3. Pull the front panel free from the housing.

Replacing the front panel of the instrument is the reverse procedure. However, ensure that the front panel is aligned at both connector points before tightening the screws.

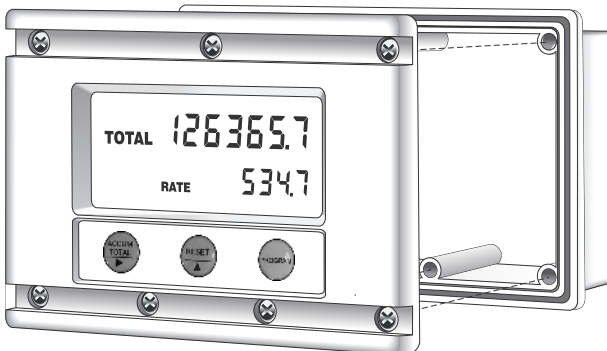
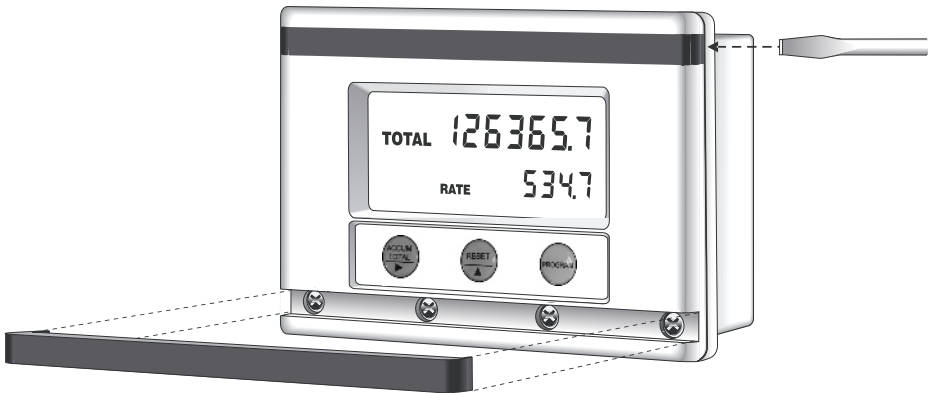

7.7.2 Removing the front panel - Metallic enclosure

The front panel should be removed as follows:

1. Unscrew the 4 x pozi drive head screws from each corner of the front panel.
2. These are retaining screws, held onto the front panel with o-rings
3. Once fully loosened the front panel will pull away from the housing.

To replace the front cover, follow the above procedure in reverse. Ensure that the front panel is aligned at connector points before tightening the screws.



If slightly stiff, the enclosure has a small gap on the right side of the front panel. This can be used to open the instrument with a tool.



29 Installation

7.8 PANEL MOUNT VERSION

The panel mount version of the Model 202Ai is supplied with two panel mount brackets and plug-in terminals which are accessible from the rear of the instrument.

A diagram of the rear panel is shown below.

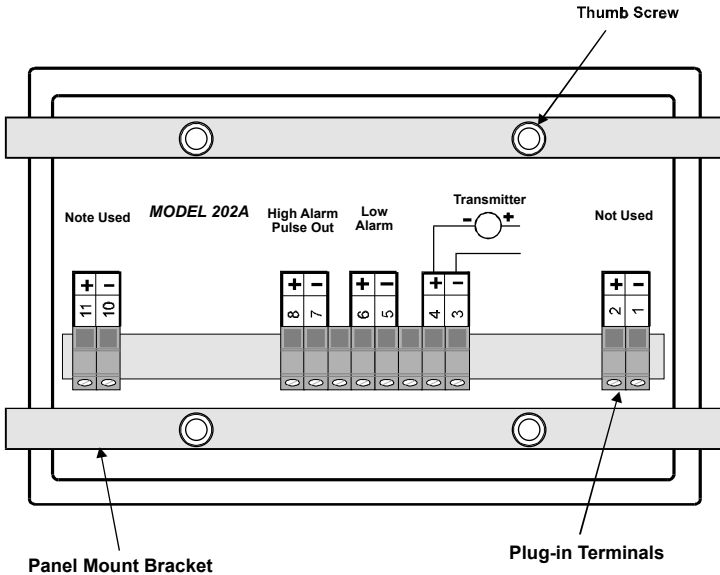

**REAR VIEW OF 202A
PANEL MOUNT CASE**

The cutout for the panel mount version is 141mm (5.55") wide x 87mm (3.43") high.

NOTE - The aluminium enclosure can not be supplied as a panel mounting instrument

7.9 INSTRUMENT DIMENSIONS

7.9.1 Aluminium / Stainless Enclosure

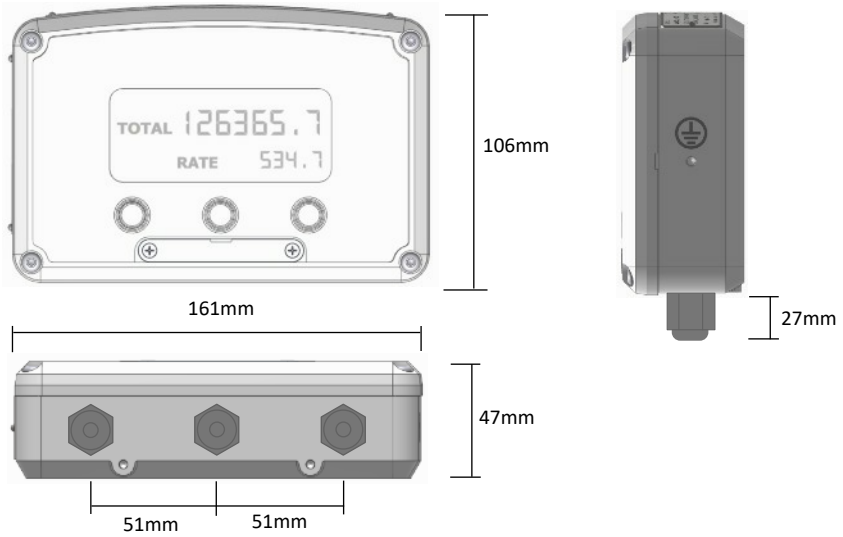

7.9.2 Plastic Enclosure

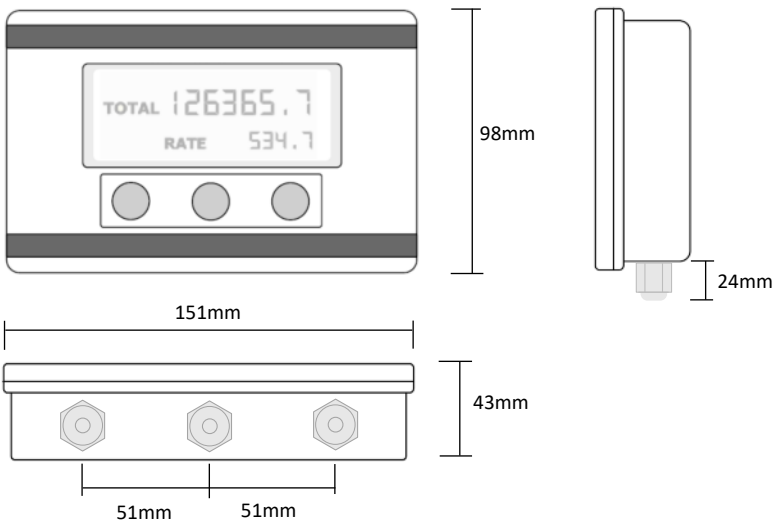

7.10 TERMINAL DESIGNATIONS

4-20mA Input

- 3 4-20mA (-)
- 4 4-20mA (+)

Outputs

- 5 Low Alarm (-)
- 6 Low Alarm (+)

- 7 High Alarm (-) or Pulse Output (-)
- 8 High Alarm (+) or Pulse Output (+)

8. INSTRUMENT DISPOSAL

Contrec instrumentation should not be thrown into the general waste system.



If within EU member states, this instrument should be disposed of according to the guidelines set by the WEEE (Waste Electrical and Electronic Equipment) directive 2012/19/EU. If outside of the EU, this equipment should be responsibly disposed of according to local and national regulations for EEE (Electrical and Electronic Equipment).

By not discarding of this product along with other house hold waste you are preserving natural resources and reducing waste sent to landfill and incinerators.

Index

A

Accumulated Total, 6, 9

C

CAL Sequences, 10
Cutoff Point, 10, 14

D

Decimal Point, 10
Display, 6, 9
Display Test, 9
Dimensions, 30

F

Filtering, 16

G

Grounding, 25

H

Hi Test, 9
High Alarm, 9, 12

I

Installation, 24
Intrinsic Safety, 4, 5, 22
Instrument Disposal, 32

L

Lo Test, 9
Low Alarm, 9, 12

M

Model Number, 3

O

Operating Temperature, 7
Operation, 9

P

Panel Mount, 29
Programming, 8
Protection, 7
Pulsating Signal, 16
Pulse Output, 20

R

Rate, 9
Removing the Front Panel, 27
Resettable Total, 9
Response, 17

S

Span, 13
Specification, 6
Safety, 1
Special Conditions of Use, 1

T

Temperature, 7
Terminal Designations, 31
Test Mode, 9
Timebase, 10, 13
Total Conversion, 15

W

Wall Mounting, 26