

Model 505 Flow Computer

Operation Manual

Application FC02

Single Channel Flow Computer
for
Volumetric Analog Flowmeter

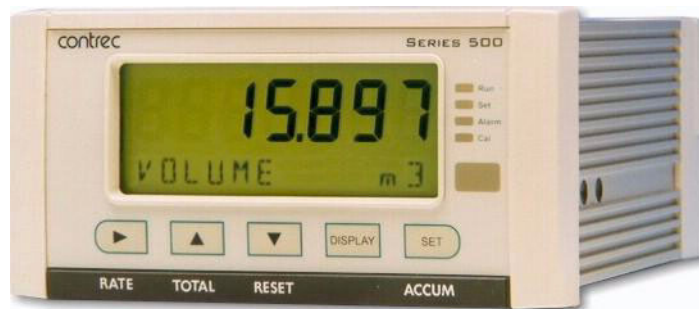

contrec

8 June 2007

Model 505 Flow Computer - Operation Manual

© Contrec Pty Ltd 2007

The instructions given herein cover the general description, installation, operation and maintenance of the subject equipment. Contrec Pty. Ltd. reserves the right, without prior notice, to make engineering refinements that may not be reflected in this manual.

Should any questions arise which cannot be answered specifically by this manual, they should be directed to Contrec Pty Ltd for further detailed information and technical assistance.

Contrec Pty. Ltd. will not accept any liability for either direct or consequential damages resulting from the use or misapplication of the contents of this manual.

Part of the software embedded in this product is eCos - Embedded Configurable Operating System, a trademark of Red Hat. Portions created by Red Hat are Copyright © 1998, 1999, 2000 Red Hat, Inc. (<http://www.redhat.com>). All rights reserved

The software in this product was in part provided by Red Hat and any express or implied warranties, including, but not limited to, the implied warranties of merchantability and fitness for a particular purpose are disclaimed. In no event shall the author be liable for any direct, indirect, incidental, special, exemplary, or consequential damages (including, but not limited to, procurement of substitute goods or services; loss of use, data, or profits; or business interruption) however caused and on any theory of liability, whether in contract, strict liability, or tort (including negligence or otherwise) arising in any way out of the use of this software, even if advised of the possibility of such damage.

Contrec Pty Ltd

22 Hall Street Hawthorn East, Melbourne 3123 AUSTRALIA
Tel: +61 3 9804 4200 Fax: +61 3 9822 8329
Email: sales@contrec.com.au

Contrec - USA, LLC

916 Belcher Drive Pelham AL 35124 USA
Tel: (205) 685 3000 Fax: (205) 685 3001
Email: contrec@contrec-usa.com

Contrec Europe Limited

PO Box 436 Sowerby Bridge, West Yorkshire HX6 3YA, UK
Tel: +44 1422 829 940 Fax: +44 1422 829 941
Email: sales@contrec.co.uk

Website: www.contrec.com.au

Publication No: 505-FC02-OM - 8 June 2007



Safety Notice

The information in this safety notice is for the prevention of injury to personnel and damage to the instrument.

The manufacturer assumes no liability for injury or damage caused by misuse of the instrument or for modifications made to the instrument.

Qualified Personnel

The instrument must be installed, operated and serviced by persons who have been properly trained and authorised. Personnel must read and understand this manual prior to installation and operation of the instrument.

Static Hazard

The 500 series flow computer uses high speed CMOS circuitry which is sensitive to static damage. The user should observe accepted safety practices for handling electronic devices, especially during servicing. Once the unit is installed, grounded and interconnected, the chances of static damage are greatly reduced.

Voltage Hazard

Before connecting power to the instrument, ensure that the supply voltage for the AC or DC input is suitable. The AC voltage rating is as stated on the serial number plate. Personnel should take all due care to avoid electric shock.

Welding Hazard

Do not perform electric welding in close proximity to the instrument or its interconnecting cables. If welding in these areas must be performed, disconnect all cables from the instrument. Failure to do so may result in damage to the unit.

Moisture Hazard

To avoid electrical faults and corrosion of the instrument, do not allow moisture to remain in contact with the instrument.

Contents

1 Introduction

Overview	1
Calculations	2
Analog Input Scaling	2
Displayed Information	2
Main Menu Variables	3
Communications	3
Retransmission Outputs	3
Relay Outputs	3
Software Configuration	3
Approvals	4

2 Specifications

General	5
Inputs	5
Outputs	5

3 Installation

Panel Mounting	7
Electrical Connection	8
Rear Panel Connections	8
Terminal Designations	8
Inputs	9
Analog Input Connections	9
Logic Input Connection	9
Outputs	10
4-20mA Output Connection	10
Pulse Output Connection	10
Control Relays (Alarms)	11
RC Network for Interference Suppression	12
Communications	12
RS-232 Port	12
Infra-red Port (Display Panel Option)	13
RS-485 Port	13
Earthing and Shielding	13

4 Operation

Normal Operation	15
Default Total	15
Status Lamps	15
Front Panel Keys	16
Main Menu Items	16
Peak Flowrates	17
User Value	17
Data Logs	17

Model Information	20
5 Instrument Calibration	
Introduction	21
Calibration View Mode	21
Calibration Set Mode	22
Changing the Instrument Settings	23
Calibration Menu Tree	24
Instrument Settings	26
Units of Measurement	26
Parameters	27
Inputs	27
Outputs	31
Alarms	32
Communications	34
Time Settings and Data Logging	36
General Setup Parameters	39
Test Menu	41
System Messages	42
Error Messages	42
Warning Messages	43
6 Communications	
Overview	45
Hardware Interconnection	45
Protocols	47
Modbus RTU Protocol	48
List of Data Registers	49
Printer Protocol	54
Types of Printouts	55
Printer Data Control	58
Appendix A Model Numbers	
Product Codes	59
Custom Version Codes	60
Application Information Code	60
Appendix B Units of Measurement	
Available Units of Measurement	62
Index	63

List of Figures

1	Typical Application Diagram	4
2	500 Series Instrument Panel Mounting	7
3	Rear Panel Connections	8
4	Externally Powered Current Loop	9
5	Internally Powered Current Loop	9
6	Logic Input Connection Diagram	10
7	Output 4-20mA Connection Diagram	10
8	Output Pulse Connection Diagram	11
9	Relay Connection Diagram	11
10	RS-485 Interface Connections	13
11	Logged Data Display Methods	19
12	Calibration Menu Tree Sheet 1	24
13	Calibration Menu Tree Sheet 2	25
14	RS-232 Cable Connections to a Computer	46
15	RS-485 Connections	46

Chapter 1

Introduction

Features

- Tailored for volumetric analog flow input
- Versatile “user value” available on main menu
- Allows for square law and non-linear correction
- Selection of second language and user tags
- RTC logging with up to 100 entries at user-specified scheduled times
- Infra-red communications port on front panel
- Pulse width and scaling of pulse output
- 4-20mA retransmission
- Selectable protocols on serial ports including Modbus RTU and Printer output
- Front panel adjustment of 8-24V DC output voltage
- Backlit display
- LCD backup

Overview

The 505 FC02 application pack is a rate totaliser for the measurement of fluid. It uses the 4-20mA analog output from a volumetric flowmeter.

The flow computer displays the flow rate, resettable total and the accumulated total in the units of measure according to the purchase order.

The analog input can be scaled as well as having filtering, square law or non-linear correction and cutoff points applied to the signal.

A freely programmable “user value” on the main menu can serve as a setpoint for the 4-20mA output or as an operator identifier to be logged.

Calculations

The following equations identify the derivation of some of the displayed variables. If your interest is more in the operation of the instrument, you can skip this section and allow the instrument to take care of the calculations.

To derive the flow rate, the analog input is normalised to a value (A) between 0 and 1.

$$\text{volumeflow} = (V_{fmax} - V_{fmin})A + V_{fmin}$$

$$\text{volume} = \int (\text{volumeflow} \cdot \Delta t)$$

Analog Input Scaling

The analog inputs in this instrument are scaled by the following general formula:

$$f(A) = P_{min} + (P_{max} - P_{min}) \cdot A^*$$

where:

P_{min} = minimum point (equivalent to offset)

P_{max} = maximum point ($P_{max} - P_{min}$ is equivalent to span)

A^* = normalised signal (0 to 1) with correction applied for a flow input

Correction Type

- **LINEAR:** $A^* = A$ when the instrument is not required to apply correction
- **NON-LINEAR:** $A^* = A_C$ when the instrument applies correction from the points in the correction table
- **SQUARE:** $A^* = \sqrt{A}$ when the transmitter does not have square root extraction and it must be applied by the instrument.

Displayed Information

The front panel display shows the current values of the input variables and the results of the calculations.

The instrument can be supplied with a real-time clock for data logging of up to 100 entries of the variables as displayed on the main menu.

Main Menu Variables

Main Menu Variables	Default Units	Variable Type
Volume	Ltr	Total
Volume Flowrate	L/min	Rate
User Value	- - -	Rate

Refer to [Available Units of Measurement](#) on page 62 for the list of available units.

Communications

There are three communication ports available as follows:

- RS-232 port (standard)
- RS-485 port (standard)
- Infra-red port (on front panel - display panel option)

The ports are available for remote data reading, printouts and for initial application loading of the instrument.

Retransmission Outputs

The instrument can re-transmit any main menu variable. The digital outputs can re-transmit totals as pulses. If the instrument has the advanced option, it outputs rates as a 4-20mA signal.

Relay Outputs

The relay alarms can be assigned to any of the main menu variables of a rate type. The alarms can be fully configured including hysteresis. Two relays are standard.

Software Configuration

The instrument can be further tailored to suit specific application needs including units of measurement, custom tags, second language or access levels. A distributor can configure these requirements before delivery.

Instrument parameters including units of measurement can be programmed in the field, according to the user access levels assigned to parameters by the distributor.

All set-up parameters, totals and logged data are stored in non-volatile memory with at least 30 years retention.

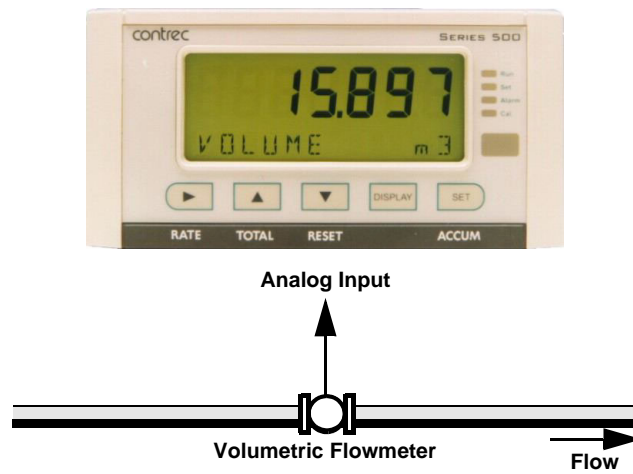

Figure 1 Typical Application Diagram

Approvals

This instrument conforms to the EMC-Directive of the Council of European Communities 89/336/EEC and the following standards:

- Generic Emission Standard EN 50081-1 Residential, Commercial & Light Industry Environment.
- Generic Emission Standard EN 50081-2 Industrial Environment.
- Generic Immunity Standard EN 50082-1 Residential, Commercial & Light Industry Environment.
- Generic Immunity Standard EN 50082-2 Industrial Environment.

In order to comply with these standards, the wiring instructions in [Chapter 3 - Installation](#) must be followed.

Chapter 2

Specifications

General

Operating Environment	
Temperature	0°C to +60°C (conformal coating) +5°C to +40°C (no coating)
Humidity	0 to 95% non condensing (conformal coating) 5% to 85% non condensing (no coating)
Power Supply	95...135 V AC or 190...260 V AC or 12...28 V DC
Consumption	Typically 6W
Protection	Sealed to IP65 (Nema 4X) when panel mounted
Dimensions	147mm (5.8") width 74mm (2.9") height 167mm (6.6") depth

Display	
Type	LCD with 7-digit numeric display and 11-character alphanumeric display (backlit option)
Digits	15.5mm (0.6") high
Characters	6mm (0.24") high
LCD Backup	Last data visible for 15min after power down (optional)
Update Rate	0.3 second

Non-volatile Memory	
Retention	> 30 years
Data Stored	Setup, Totals and Logs

Approvals	
Interference	CE compliance
Enclosure	ATEX, FM, CSA and SAA approved enclosures available for hazardous areas

Real Time Clock (Optional)	
Battery Type	3 volts Lithium button cell (CR2032)
Battery Life	5 years (typical)

Inputs

4-20mA Input	
Overcurrent	100mA absolute maximum rating
Impedance	250 ohms (to common signal ground)
Accuracy	0.1% typical full scale (20°C) 0.2% (full temperature range)
Non-linearity	Up to 20 correction points (flow inputs)

Remote Key Input	
Signal Type	CMOS, TTL, open collector, reed switch
Configuration	One input set as one of front five keys

Outputs

Relay Output	
No. of Outputs	2 relays
Voltage	250 volts AC, 30 volts DC maximum
Current	3A maximum

Communication Ports	
Ports	RS-232 port RS-485 port Infra-red port (optional)
Baud Rate	2400 to 19200 baud
Parity	Odd, even or none
Stop Bits	1 or 2
Protocols	Modbus RTU, Printer

Transducer Supply	
Voltage	8 to 24 volts DC, programmable
Current	70mA @ 24V, 120mA @ 12V maximum
Protection	Power limited output

Pulse/Digital Output

Signal Type	Open collector, non-isolated
Switching	200mA, 30 volts DC maximum
Saturation	0.8 volts maximum
Pulse Width	Programmable: 10, 20, 50, 100, 200 or 500ms

4-20mA Output (Optional)

Supply	24 volts DC internal, non-isolated
Resolution	0.05% full scale
Accuracy	0.05% full scale (20°C) 0.1% (full temperature range, typical)

Important: Specifications are subject to change without notice.

Chapter 3

Installation

Panel Mounting

The instrument should be located in an area with a clean, dry atmosphere that is also relatively free of shock and vibration.

The standard mounting procedure is panel mounting in a cutout that is 139mm wide by 67mm high. Two side clips secure the unit into the panel.

Figure 2 shows the panel mounting requirements for the 500 Series Instrument.

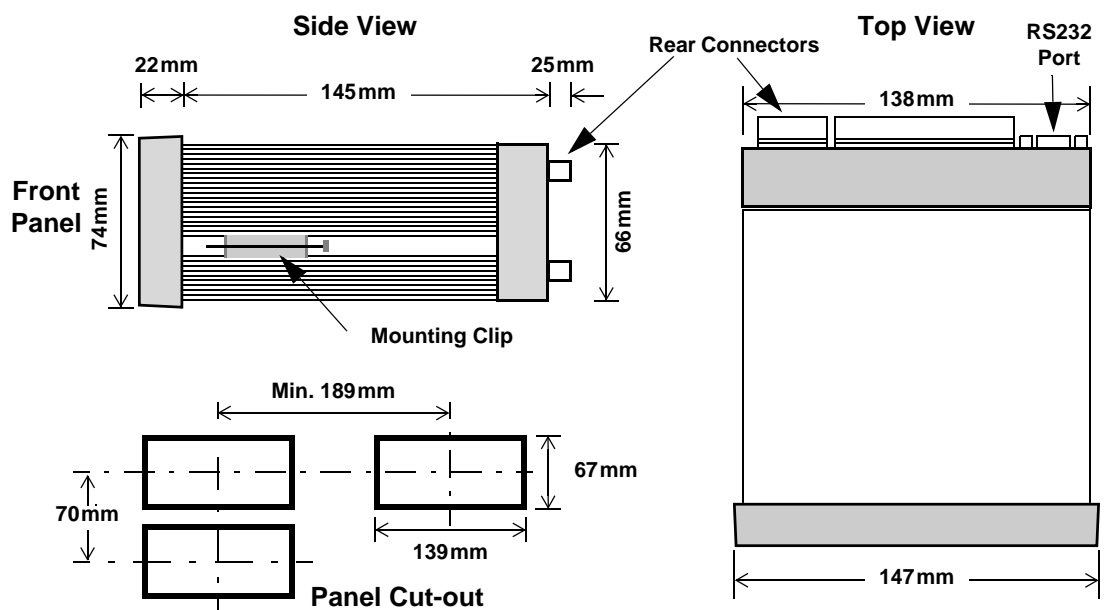

Figure 2 500 Series Instrument Panel Mounting

Electrical Connection

Rear Panel Connections

Figure 3 shows the connections on the rear panel of the instrument.

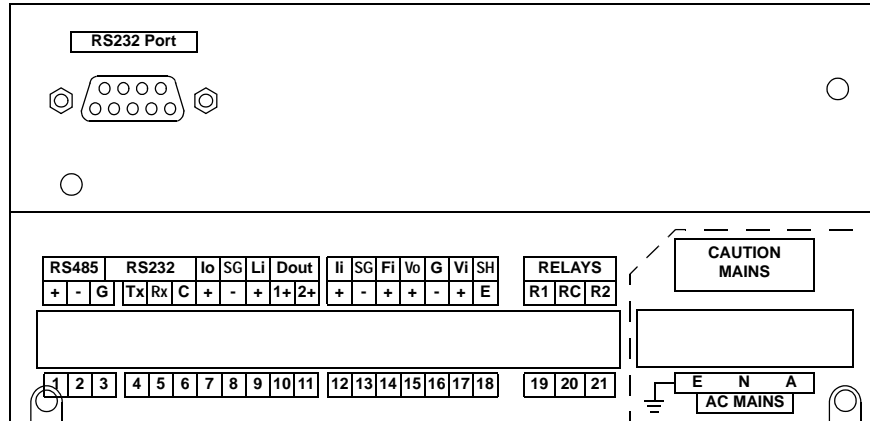

Figure 3 Rear Panel Connections

Terminal Designations

Terminal Label	Designation	Comment		
1	RS485 +	RS485 (+)		
2	RS485 -	RS485 (-)		
3	G	Comms ground		
4	Tx	RS232 data out		
5	Rx	RS232 data in		
6	C	CTS (Clear to send)		
7	I _o +	4-20mA output		
8	SG -	Signal Ground 0V		
9	L _i +	Logic input		
10	D OUT	1+	Open collector o/p 1	
11		2+		Open collector o/p 2
12	I _i +	4-20mA input		
13	SG -	Signal Ground 0V		
14	F _i +	Frequency input		
15	V _o +	8-24 volts DC output		
16	G -	DC Ground		
17	V _i +	DC power input		
18	SH E	Shield terminal		
19	RELAYS R1	Relay 1		
20	RELAYS RC	Relay Common		
21	RELAYS R2	Relay 2		
E	AC MAINS	E	Mains ground	
N		N		Mains neutral
A		A		
RS232 port	9-pin serial port			

Inputs

Analog Input Connections

The analog input (Ii) can accept current signals from 4 to 20mA.

CAUTION

Applying levels of input current above the absolute maximum rating (100mA) may cause permanent damage to the input circuitry.

4-20mA Inputs

For an externally powered current loop, connect the transmitter to the input terminals as shown in Figure 4.

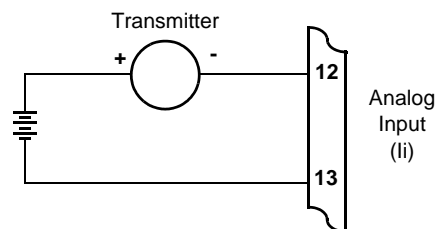

Figure 4 Externally Powered Current Loop

Connect internally powered current loops as shown in Figure 5.

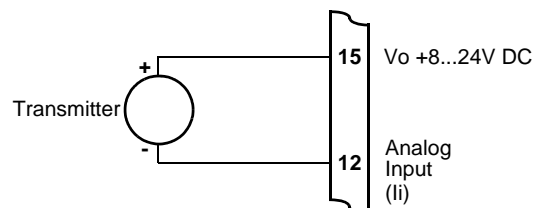

Figure 5 Internally Powered Current Loop

Logic Input Connection

These input(s) are designed to be connected to open collector signals or a voltage free contact switch. A minimum activation time of 300ms is required to guarantee reading of an input.

Remote Key Input

Connect a remote push-button key to the Logic Input as shown below. Refer to **REMOTE KEY** on page 30 to define the function of the key.

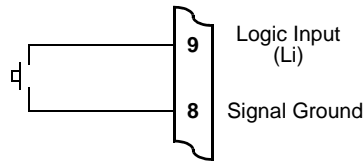

Figure 6 Logic Input Connection Diagram

Outputs

The basic instrument has two pulse outputs. The advanced option also provides a 4-20mA output port.

4-20mA Output Connection

Figure 7 shows the connections for a 4-20mA output.

Maximum Load Resistance = 900 ohms

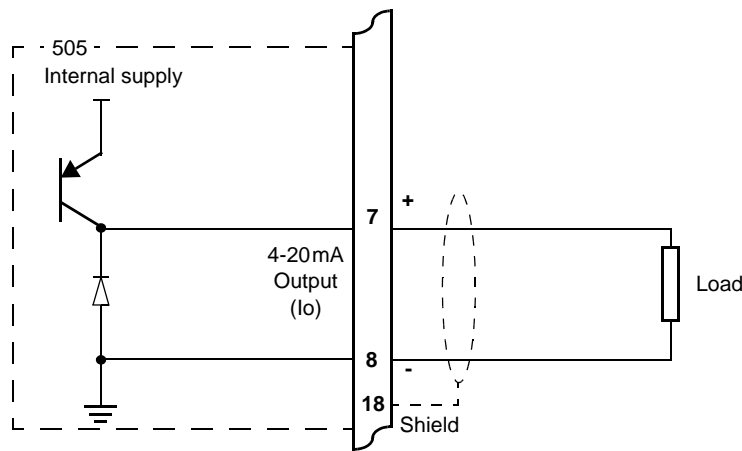

Figure 7 Output 4-20mA Connection Diagram

Pulse Output Connection

Figure 8 shows a connection example for a pulse output. Output channel 1 uses terminals 10 (+) and 8 (-). Output channel 2 uses terminals 11 (+) and 8 (-).

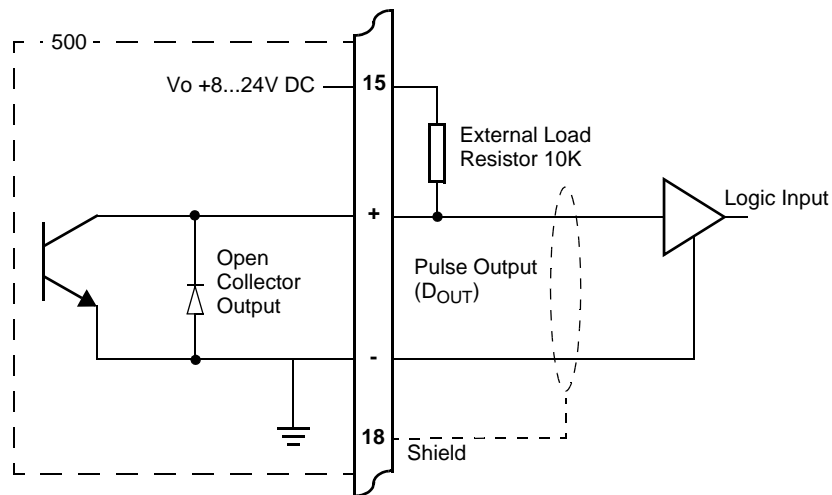

Figure 8 Output Pulse Connection Diagram

Control Relays (Alarms)

The standard instrument has two alarm relays, which can be used to drive external devices such as external relays, lamps, and audible alarms. The operation of each alarm relay can be set to various modes as described in [Alarms](#) on page 32.

There is also an equipment failure alarm option. This alarm can have normally closed (open) contacts which open (close) when the instrument displays any error message as listed in [Error Messages](#) on page 42, or if there is a loss of power to the instrument.

The output characteristics of the relays are:

- Maximum Voltage 30 volts DC or 250 volts AC
- Maximum Current 3 A

Note: Solid state relays use AC voltage only.

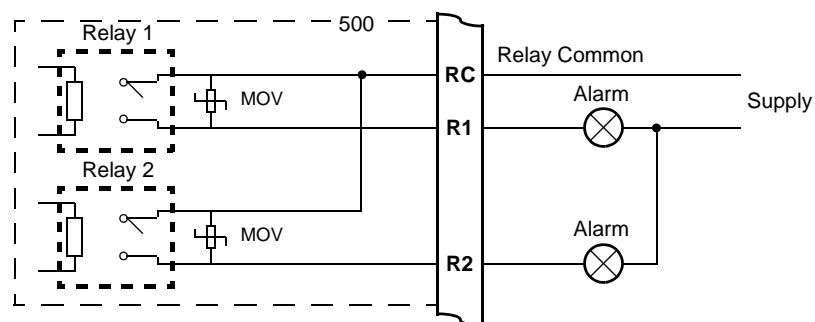

Figure 9 Relay Connection Diagram

RC Network for Interference Suppression

When driving highly inductive loads with the relay outputs, it is recommended to use RC suppression networks (often called “Snubbers”) for the following reasons:

- To limit the amount of electrical noise caused by arcing across the contacts, which may, in extreme cases, cause the microprocessor to act erratically.
- To protect the relay contacts against premature wear through pitting.

RC suppression networks consist of a capacitor and series resistor and are commonly available in the electrical industry. The values of R and C are dependent entirely on the load. However, if the user is unsure of the type of snubber to use, values of 0.25 μ F and 100 Ω will usually suffice. Note that only mains-approved RC suppression networks should be used.

The basic principle of the operation is that the capacitor prevents a series of sparks arcing across the contact as the contact breaks. The series resistor limits the current through the contact when the contact first makes.

Communications

The communication protocols are described in [Communications](#) on page 45.

RS-232 Port

The standard RS-232 port uses terminals 4, 5 and 6 on the rear panel.

The extra RS-232 port 9-pin DB female connector has the following pinout:

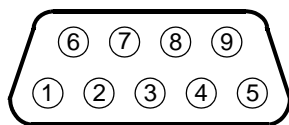

Pin 1	Not used
Pin 2	Transmit (TxD)
Pin 3	Receive (RxD)
Pin 4	Not used
Pin 5	Ground
Pin 6	Not used
Pin 7	Handshake line (CTS)
Pin 8	RTS Out
Pin 9	Not used

Note: The instrument does not require a null-modem cable for connection to a personal computer. Refer to [Hardware Interconnection](#) on page 45 for cable termination requirements.

Infra-red Port (Display Panel Option)

The infra-red port is located at the front panel, directly below the row of status indicators. The main function of this port is for retrieving current or logged data with a PC that has an infra-red port.

RS-485 Port

Up to 32 units can be connected to a common RS-485 bus. Each unit has a unique address that the host computer uses to identify each instrument.

Figure 10 shows the connection of several instruments to a computer using the RS-485 port.

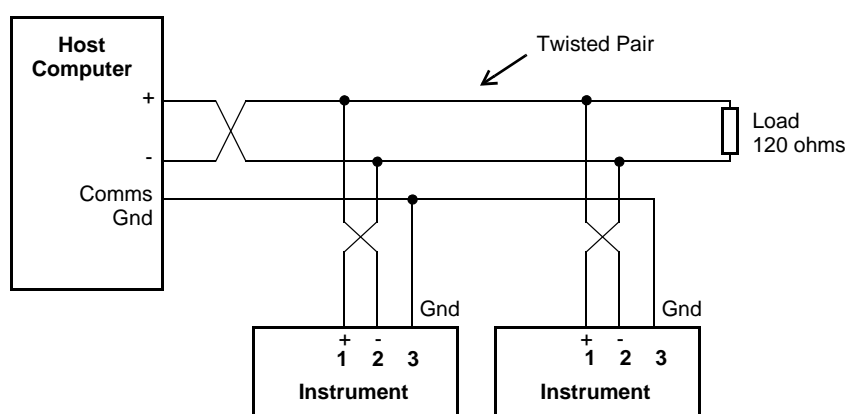

Figure 10 RS-485 Interface Connections

Earthing and Shielding

It is a good practice to use shielded cable for all signal connections to the instrument. Care must be taken to separate signal cables from power cables to minimize interference.

Overall earth should be connected at the instrument end only. This connection should be as short as possible and connected to the earthing point on the rear terminal at pin 18.

Chapter 4

Operation

Normal Operation

In normal operation mode, you press the buttons on the front panel to display the values recorded and calculated by the instrument. There are four categories of information that the instrument can display:

- Totals
- Rates
- Process variables
- Instrument settings

For each total, there is an associated rate as follows:

Total	Rate
Volume	Volume Flowrate





Default Total

In some applications, one set of variables is of more interest than others, and for this reason a default total and its associated rate can be assigned during instrument calibration. This default total can be used in two ways:

- The default variables come first in the sequence of totals and rates that are displayed with the front panel keys.
- If the display timeout option is enabled and no buttons are pressed for the selected period (usually 30 seconds) the display returns to the default total.

Status Lamps

The status lamps illuminate to show the following conditions:

 Run	Run The host computer is downloading the application software.
 Set	Set The instrument is in Calibrate Set mode.
 Alarm	Alarm The instrument has an error, as indicated on the display panel.
 Cal	Cal The instrument is in Calibrate View mode.

Front Panel Keys

For most actions with the front panel keys, you can hold a key to scroll through the values or options, instead of repeatedly pressing the key.

RATE Press the **RATE** key to display the rate that is associated with the currently displayed total. If an item other than a rate or total is displayed, press the **RATE** key to display the “default rate”. When a rate is displayed, press or hold the **RATE** key to display the other rate variables in turn.

TOTAL Press the **TOTAL** key to display the total that is associated with the currently displayed rate. If an item other than a rate or total is displayed, press the **TOTAL** key to display the “default total”. When a total is displayed, press or hold the **TOTAL** key to display the other total variables in turn.

RESET Use the **RESET** key to clear all resettable totals or to initiate a printout if the printer option has been selected. The printout is activated with a single press while the Total Reset function has four reset modes that are selectable during instrument calibration as follows:

- NONE - The user cannot reset the non-accumulated totals.
- INSTANT - When the user presses the **RESET** key, the instrument resets all non-accumulated totals.
- DELAYED - When the user holds the **RESET** key for two seconds, the instrument resets all non-accumulated totals.
- CAPTURE - When the user presses the **RESET** key, the instrument resets all non-accumulated totals, with the last value being displayed for 15 seconds. Totalising is maintained in the background while the captured value is held on the display.

The instrument makes three beeps when it resets the totals and two beeps when a printout is started.

DISPLAY Press the **DISPLAY** key to step or scroll through the main menu items.

ACCUM Hold the **ACCUM** key to display the accumulated value for the currently displayed total or to display the peak value for the currently displayed flowrate. See below for further details of peak flowrates.

Main Menu Items

The main menu in this instrument consists of the following items. The **DISPLAY** key is used to step or scroll through the list.

DISPLAY ↓	Description	Options
VOLUME	Volume	Hold the ACCUM key to display accumulated total
FLOW	Volume flowrate	Hold the ACCUM key to display peak value

DISPLAY ↓	Description	Options
USER	User entered value	Hold the SET key to edit the current User Value (see below for details).
REPORT PRINT	Only shown if print option is selected	Hold the SET key to print log report as defined in the TM/LOG section of calibration.
LOGGED DATA	Only shown if real-time clock option is installed	Hold the SET key to display data logs as described in Data Logs on page 17.
MODEL INFO		Hold the SET key to display the Model information as described in Model Information on page 20.
CAL MENU		Hold the SET key to enter Calibration View mode as described in Calibration View Mode on page 21.

Peak Flowrates

The peak value for the currently displayed flowrate can be viewed by holding the **ACCUM** key. The peak value is the average over a 15 minute period since the last reset of totals or powering on of the instrument. Dashes are shown for this value after a reset or power on until the first averaging period has passed.

User Value

SET Hold the **SET** key to edit the current User Value while viewing the User Value in the main menu. The display of the User Value will change from view mode to edit mode after 2 seconds if access has been enabled in calibration. Once in edit mode the **Set** indicator will illuminate and the User Value is changed in exactly the same way as in calibration set mode.

The User Value can be used in a range of ways. The value (as any other main menu variable) is logged and can be freely assigned to outputs or alarms. It can be entered in the range of 0 to 999999.9. Some examples of uses for the User Value are as an Operator Identifier or a Control Setpoint.

Data Logs

The instrument will log the main-menu variables if real-time clock option is installed. The logs are at fixed intervals which can be programmed to a combination of hours, days, weeks, months and years. The instrument can store a total of 100 log entries.

If the number of log entries exceeds the programmed number for a particular time interval, the oldest log entry is overwritten by the newest one for that time interval. Also note that the totals are saved as accumulated totals.

The log entries are recorded at the following times:

HOUR 00 minutes each hour
DAY 00 hours and 00 minutes each day
WEEK 00 hours and 00 minutes each Monday
MONTH 00 hours and 00 minutes on the first day of the month
YEAR 00 hours and 00 minutes on the first day of the year.

View Data Logs

Use the following procedure to view the data that has been logged by the instrument:

1. Press the **DISPLAY** key to scroll through the menu to the **LOGGED DATA** prompt.
2. Hold the **SET** key.

The system displays the hourly log. The timebase and number of the log are shown, for example LH-001.

3. While holding the **DISPLAY** key use the **RESET** key to print the data for the displayed log if the printer option has been selected.

The following example shows the hourly log number 006 at 15:00 (3:00 pm) on 16 January 2002. The day and month alternate with the year in the bottom right hand corner.

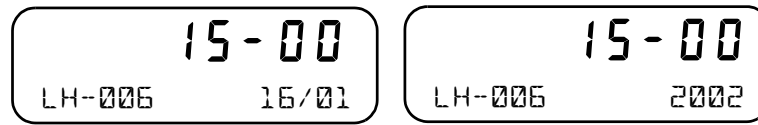

Figure 11 shows how to display the logged data.

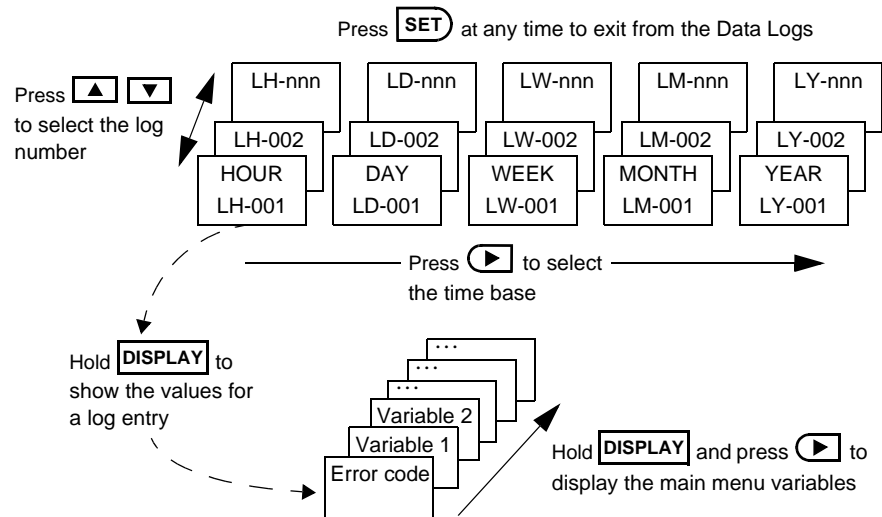

Figure 11 Logged Data Display Methods

Model Information

The model information items display the hardware, software and application versions of the instrument. This information is mainly for service personnel.

<div style="border: 1px solid black; padding: 2px;">DISPLAY</div> ↓	Description
- 1 - - F - 505 MODEL	The hardware model code. Refer to Product Codes on page 59 for more information.
- A FC02 INPUT	The Application number and the assignment of the inputs. Refer to Application Information Code on page 60 for more information.
0 10 1.002 FC02 VERS	The version of software loaded into the instrument.
026357 CUSTOM VERS	The Customer version code for this installation. Refer to Custom Version Codes on page 60 for more information.
123456 ABC123 S/N	The instrument serial number and unit tag. The serial number is on the top line and unit tag is on the bottom left. Both items are entered when the instrument application software is initially loaded. If the unit tag is not used the default tag, UNIT, will be used.
16 - 15 EDITED 27/08 2002	<p>The time and date when the calibration of the instrument was last edited. The format of the time and date is the same as for the data logs. This example shows 16:15 (4:15pm) on the 27th August 2002.</p> <p>This function is available only if the instrument has the real time clock option.</p>

Press SET at any time to exit from the Model information.

Chapter 5

Instrument Calibration

Introduction

You can view or change the settings of the instrument according to the access level for each parameter as set by the manufacturer. There are four levels of access to the parameters as follows:

- **Not visible** - you cannot display or edit the parameter.
- **Display Only** - you can display the parameter, but you cannot change the setting.
- **Programmable** - you can change the setting of the parameter in Calibration Set mode.
- **Password protected** - you can change the setting of the parameter in Calibration Set mode only if you enter the correct password.

Note: When you enter Calibration Set mode, the instrument requests you to enter a password. Any value will allow to change the settings of the “programmable” parameters, but the correct password must be entered to change the password-protected parameters.

Calibration View Mode

Use the following procedure to view the calibration settings of the instrument:

1. Press **DISPLAY** to scroll to the **CFM MENU** prompt.
2. Hold the **SET** key.



The instrument beeps once, illuminates the **Cal** indicator and shows **CFM** on the display panel.

- Press **▶** to scroll through the flashing menu headings.
 - Press **SET** to scroll through submenu items.
 - Press **DISPLAY** to return to the main calibration menu.
3. To exit from the Calibration View mode, press **▶** to scroll to the **END** option and press **SET**.

The instrument returns to Normal Operation mode.

Calibration Set Mode

In Calibration Set mode, you can change the settings of the “programmable” parameters. You must enter the system password to change the setting of the “password-protected” parameters.

Use the following procedure to enter Calibration Set mode:

1. Press **DISPLAY** to scroll to the **FL MENU** prompt.

2. Hold the **SET** key.



The instrument beeps once, illuminates the **Cal** indicator and shows **FL** on the display panel.

3. Press **▶** to select any flashing menu heading except **END**.

4. Hold **SET** for two seconds.

The instrument requests a password.

5. Press **▲** or **▼** to change the value of the current digit. To select the next digit, press **▶**.

6. Press **SET** to accept the password.

- The instrument makes two beeps for a correct password entry and enables you to change the “programmable” and “password-protected” parameters.
- The instrument makes one beep for an incorrect password entry and enables you to change only the “programmable” parameters.



The instrument illuminates both the **Cal** and **Set** indicators.

7. Edit the instrument parameters as required. The programmable values are indicated by the flashing display.

- To change a numerical value, press **▲** to increase a value, or press **▼** to decrease a value. Press a key momentarily to change the value one number at a time. Hold a key to scroll through the numbers. To proceed to next digit, press **▶**.
- To change an option setting, press **▲** or **▼** to scroll through the options.

8. Press **SET** to accept the currently displayed value and proceed to the next parameter. You can press **DISPLAY** to return to the main calibration menu.

9. To exit from Calibrate Set mode, press **▶** to scroll through the main calibration menu to **END**, then press **SET**. Otherwise, from any menu, you can press and hold **SET** for two seconds.



The instrument makes two beeps and cancels the **Cal** and **Set** indicators.

Changing the Instrument Settings

In Calibration Set mode, the display flashes the item that can be changed. For option settings, the display flashes the complete option. For a numeric parameter, the display flashes one digit at a time, you can change the value of the flashing digit as required, then move the flashing cursor to change another digit.

Note: When you change the setting of a parameter, the instrument records the result as soon as you move to another parameter, or exit from the Calibration Set mode.

Changing Option Settings

When you display an option that can be changed, the entire option flashes on the display, such as the choices of ODD, EVEN or NONE for the communications parity bit checking. Press or to change the option. You can “scroll” through the options in either direction to make a selection as shown below.

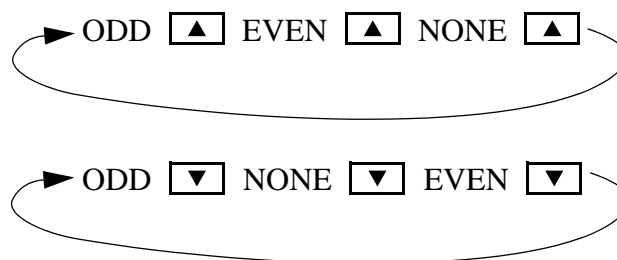

Changing Numeric Settings

The display flashes the digit that can be changed.



Press to select the digit that you wish to change.

Press or to increase or decrease the value of the selected digit.

Changing the Decimal Point

To change the position of the decimal point, press to move the flashing selection until the decimal point flashes. Press or to move the decimal point to the right or left as required.

Units of Measurement

The calibration of some parameters is based on the units that are defined for the relevant variables. These units of measurement can be viewed in the UNITS menu in calibration below.

Calibration Menu Tree

Figure 12 and Figure 13 show the keys for moving around the calibration menu tree in Calibration View or Set mode.

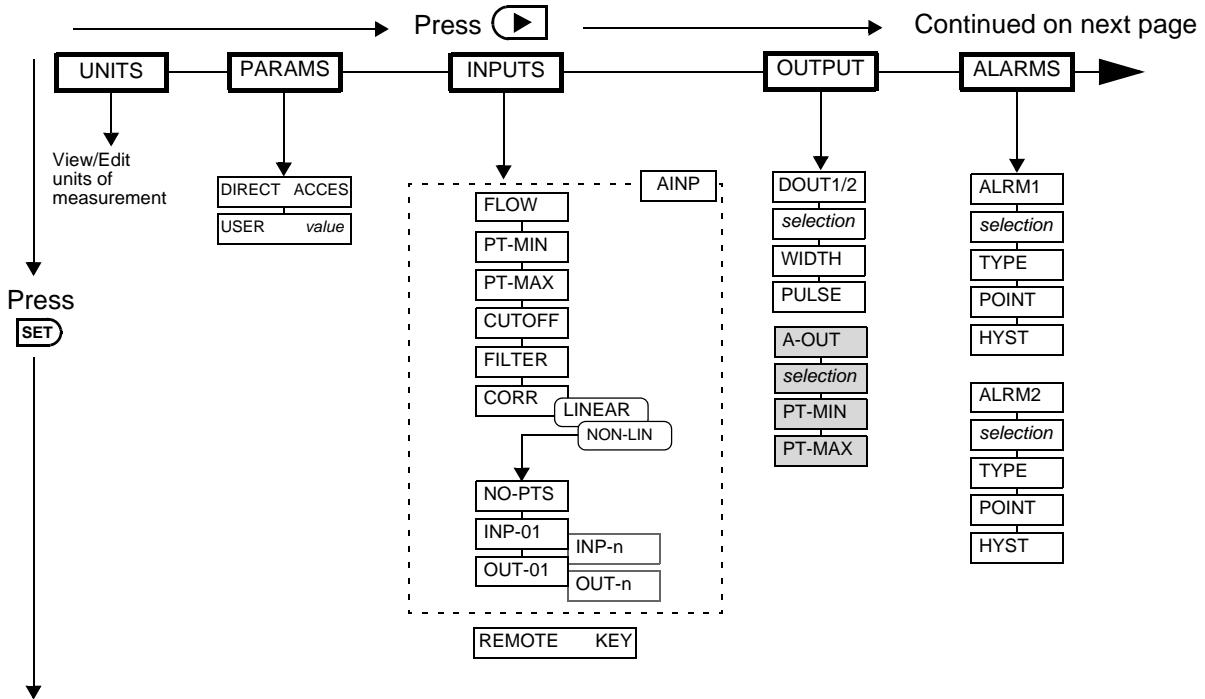
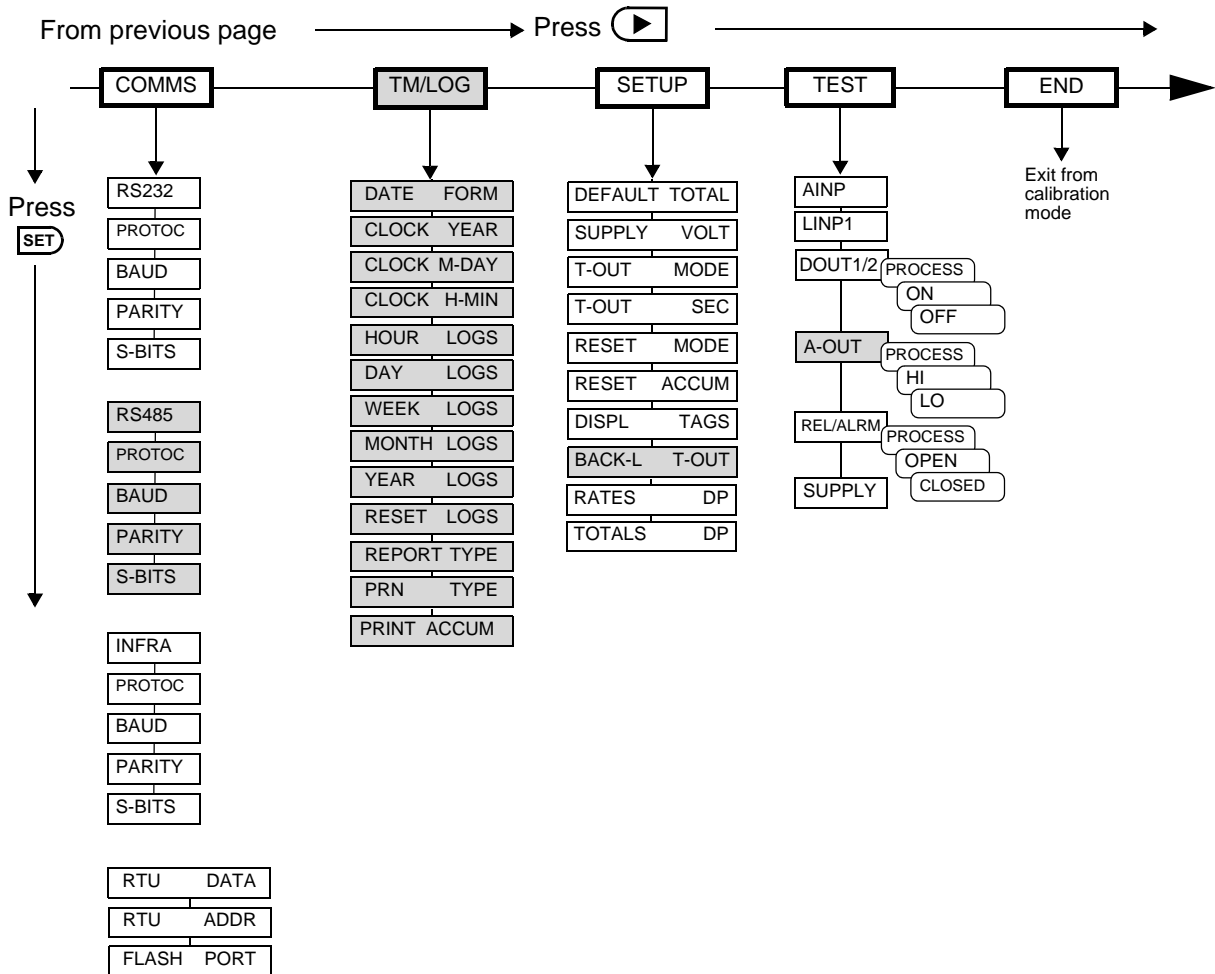

Figure 12 Calibration Menu Tree Sheet 1



The shaded boxes indicate advanced options

Press **DISPLAY** at any point to return to the main calibration menu.









Press at any I/O assignment position to move to the next I/O assignment in the submenu (eg pressing on ALRM1 will move you to ALRM2)

Figure 13 Calibration Menu Tree Sheet 2





Instrument Settings

Units of Measurement



The Units menu allows the units to be viewed and edited if necessary without the reloading of new application software. Any change in units will result in a full reset to initially downloaded settings. Therefore, any required changes to units of measurement should be made before changing any other settings.

 ↓	 → UNITS INPUTS OUTPUTS ALARMS COMMS TM/LOG SETUP TEST END
ITEM <i>n</i> <i>unit</i>	<p>The units for main menu or calibration items can be viewed by pressing the  key.</p> <p>The units of measurement are password protected. To edit the units the correct password must be entered on entry to EDIT mode.</p> <p>Press  or  to select the required units. Refer to Available Units of Measurement on page 62 for the list of available units.</p>
ACCEPT UNITS	<p>The Accept Units prompt will only appear if one or more of the units have been changed.</p> <p>IMPORTANT: Accepting the change of units will initiate a master reset. All calibration parameters will revert to their default value (i.e. those values included in the downloaded instrument software). All totals and any logged information will be cleared.</p> <p>Press  or  to select YES, then press the  key. The instrument makes three beeps to confirm the reset command.</p> <p>The message -RESET- PLEASE WAIT will be displayed as the instrument exits calibration mode and completes a full re-boot sequence.</p>

Parameters

 ↓	 → PARAMS INPUTS OUTPUTS ALARMS COMMS TM/LOG SETUP TEST END
DIRECT ACCES	<p>If the direct access is enabled then the operator is able to enter edit mode for the User Value directly from the main menu by holding the  key while viewing the parameter. If disabled the parameter can only be changed from within calibration set mode (or via serial communications, see below). Select the direct access mode as required.</p> <p>Press  or  to select ENABLE or DISABLE.</p>
<p>Modbus Accessible Parameters</p> <p>The following PARAMS menu item is also accessible via Modbus communications. For Modbus register listing, refer to .</p>	
USER VALUE	<p>Enter the User Value as required.</p> <p>This parameter can accept a value in the range 0 to 999999.9</p>

Inputs







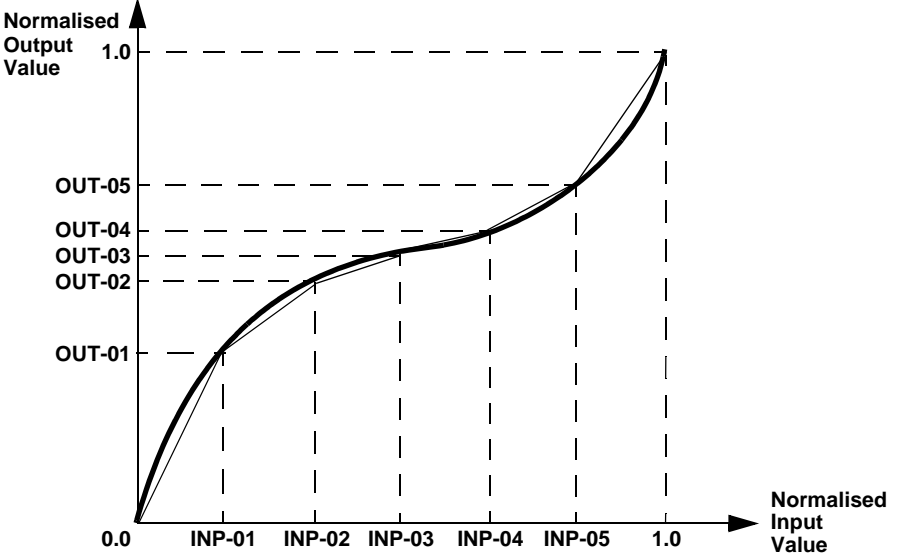

 ↓	 → UNITS PARAMS INPUTS OUTPUTS ALARMS COMMS TM/LOG SETUP TEST END
<p>Analog Input</p>	
INPUT FLOW AINP	<p>For this application, the Analog Input is assigned to volume flowrate.</p>
TYPE AINP	<p>This step identifies the type of analog input source.</p> <p>For this 505 model instrument the input is fixed to 4-20mA.</p>
PT-MIN AINP PT-MAX	<p>Enter the value of the measured parameter (in the assigned engineering units) that corresponds to the minimum input signal level. The minimum point is commonly set at a base flowrate of 0.0.</p> <p>Enter the value of the measured parameter (in the assigned engineering units) that corresponds to the maximum input signal level. The maximum point is the same as the base value (set at the minimum point) plus the span value.</p> <p>For example, if the source signal is 4mA at a minimum volumetric flowrate of 2m³/M, enter 2 as the minimum point. If the source signal is 20mA at a maximum volumetric flowrate of 250m³/M, enter 250 as the maximum point.</p>

SET ↓	▶ → UNITS PARAMS INPUTS OUTPUTS ALARMS COMMS TM/LOG SETUP TEST END		
CUTOFF RINP	<p>The Cut-off is the lowest value that the instrument reads from the input sensor. The cut-off setting is the percentage of the span of the input values.</p> <p>All inputs at or below the cut-off value are considered negligible to the instrument and are ignored. In this case, the instrument uses the minimum value (set at PT-MIN).</p>		
FILTER RINP	<p>Input fluctuations caused by pulsating flow tend to create distortion in the input readings of the rate. The instrument has a digital filter that averages out these fluctuations.</p> <p>As a guide to the degree of filtering to use, the following table shows the response time (in seconds) to reach 90% and 99% of a step change in input.</p> <p>The value A is the filter constant that the user can set.</p>		
	Filter setting A	Seconds to reach 90% of full swing	Seconds to reach 99% of full swing
	0	0	0
	2	2	4
	4	4	8
	6	5	10
	10	8	15
	15	12	23
	20	14	27
	25	18	34
	35	25	48
	45	32	62
	60	42	82
	75	52	102
	90	62	122
	99	68	134
	The input filter range is from 0 to 99. A setting of 0 (zero) means that there is no filtering.		

<input type="button" value="SET"/> ↓	<input type="button" value="▶"/> → UNITS PARAMS INPUTS OUTPUTS ALARMS COMMS TM/LOG SETUP TEST END
CORR F INP	<p>Analog input non-linearity can be corrected as follows:</p> <ul style="list-style-type: none"> • LINEAR is used if the flowmeter provides a linear signal • SQUARE is used if the flowmeter requires square root extraction • NON-LINEAR to use the following linearity correction parameters <p>Use <input type="button" value="▲"/> or <input type="button" value="▼"/> to select LINEAR, SQUARE or NON-LINEAR.</p>
NO-PTS F INP	<p><i>This parameter is available for viewing and editing only when the correction type is set to Non-linear.</i></p> <p>Enter the number of non-linearity correction points.</p> <p>Press <input type="button" value="▲"/> or <input type="button" value="▼"/> to select a number between 1 and 20 for the number of correction points.</p>

<p>SET ↓</p>	<p>▶ → UNITS PARAMS INPUTS OUTPUTS ALARMS COMMS TM/LOG SETUP TEST END</p>
<p>INP-01 RINP to INP-n</p>	<p><i>This parameter is available for viewing and editing only when the correction type is set to Non-linear.</i></p> <p>Enter the normalised input value for the correction point.</p> <p>The instrument uses linear interpolation between the correction points. An input and an output value are entered for each correction point. The values are normalised between the minimum point (0.0) and the maximum point (1.0). Only the points between 0 and 1 are required to be entered and should be entered in ascending order.</p> <p>The following diagram shows a 5 point linearised representation of the input from a hypothetical transmitter. The heavy black line represents the actual input from the transmitter. The light black line is the approximation that the instrument uses.</p>  <p>You can press the DISPLAY key to skip the non-linear points and go to the next item.</p>
<p>OUT-01 RINP to OUT-n</p>	<p><i>This parameter is available for viewing and editing only when the correction type is set to Non-linear.</i></p> <p>Enter the normalised output value for the correction point.</p>
<p>REMOTE KEY</p>	<p>You can assign the remote key input to duplicate any one of the key switches on the front panel.</p> <p>Press ▲ or ▼ to select NO-1 through NO-5 as the key on the front panel (from left to right) that is set as the remote key input. Select NONE to disable the remote key function.</p>

Outputs

 ↓	 → UNITS PARAMS INPUTS OUTPUTS ALARMS COMMS TM/LOG SETUP TEST END
VOLUME OUT _n	<p>You can assign any of the “total” main menu variables to a pulse output.</p> <p>Press  or  to select the variable that is required as an output.</p>
WIDTH OUT _n	<p>Pulse output is usually used to drive remote counters. Set the pulse width (in milliseconds) as required by the remote counter.</p> <p>Press  or  to set to: 10, 20, 50, 100, 200 or 500ms.</p>
PULSE OUT _n	<p>The Output Pulse Factor is the scaling factor for the retransmission of the measured total quantity.</p> <p>For example, if “volume” is chosen as an output variable and engineering unit is cubic metres, then a pulse factor of 1.000 generates one pulse for 1 m³. Similarly, a pulse factor of 3.000 generates one pulse for 3 m³.</p> <p>For more information, see Output Pulse Factor on page 32.</p> <p>The output pulse factor cannot be 0 (zero).</p>
V-FLOW R-OUT	<p>You can assign any of the “rate” main menu variables to the 4-20mA output.</p> <p>Press  or  to select the variable that is required as an output.</p>
PT-MIN R-OUT PT-MAX R-OUT	<p>The output minimum value corresponds to the 4 mA point and the output maximum value corresponds to the 20mA point.</p> <p>Setting the output range differently from the input range enables the instrument to amplify the input signal. You can drive a chart recorder that “zooms in” on a specified range of values instead of displaying the full operating range of the transducer.</p> <p>For example, if “volume flow” is chosen as an output variable and engineering unit is cubic metres per minute, then setting the minimum point to 30 and the maximum point to 100 would reflect the volumetric flow rate range of 30 to 100m³/min. At rates above the maximum and below the minimum points, the output remains at 20mA and 4mA respectively.</p>

Output Pulse Factor

Increasing the output pulse width reduces the maximum frequency at which a total variable can be retransmitted. Pulses will be missed if the output cannot “keep up” with the rate of total counts. You can use the output pulse factor to ensure that this maximum is not reached.

The maximum pulse output frequency is determined by:

$$\frac{1000}{(2 \times \text{pulse width in ms})} \text{Hz}$$

The minimum pulse factor required is determined by:

$$\frac{\text{max rate of total}}{\text{max pulse output frequency}}$$

For example: To calculate the required pulse factor to avoid losing counts in retransmission if a total counts at a maximum rate of 75 units/sec (Hz) and the required pulse width of a remote counter is at least 50ms:

The maximum pulse output frequency is: $\frac{1000}{2 \times 50} = 10\text{Hz}$

The minimum pulse factor for that frequency is: $\frac{75}{10} = 7.5\text{Hz}$

Alarms

The alarm relay(s) can be assigned to rate variables such as volume flowrate, or set as an equipment failure alarm.

The alarm switches “on” whenever an alarm condition exists. The alarm switches “off” when the alarm condition no longer exists. However, you may need to configure external alarm devices that require acknowledgement for cancelling an alarm.

Equipment Failure Alarm

Any alarm relay can be assigned as an equipment failure alarm. This alarm setting can have normally closed (open) contacts that open (close) when the instrument displays any error message as listed in [Error Messages](#) on page 42, or if there is a loss of power to the instrument.

<input type="button" value="SET"/> ↓	<input type="button" value="▶"/> → UNITS PARAMS INPUTS OUTPUTS ALARMS COMMS TM/LOG SETUP TEST END
RELAY ALRM n	<p>Select a rate variable to assign to the alarm relay.</p> <p>Note: If the alarm type is set to “equipment alarm”, this relay assignment setting is ignored.</p> <p>Press <input type="button" value="▲"/> or <input type="button" value="▼"/> to select the variable that is required as an alarm.</p>
TYPE ALRM n	<p>The options available for alarm types are as follows:</p> <ul style="list-style-type: none"> • HI-NO — High Alarm, Normally Open contacts • HI-NC — High Alarm, Normally Closed contacts • LO-NO — Low Alarm, Normally Open contacts • LO-NC — Low Alarm, Normally Closed contacts • BD-NO — Band Alarm, Normally Open contacts • BD-NC — Band Alarm, Normally Closed contacts • AL-NO — Equipment Alarm, Normally Open contacts • AL-NC — Equipment Alarm, Normally Closed contacts <p>Press <input type="button" value="▲"/> or <input type="button" value="▼"/> to select the type of alarm required.</p>
POINT ALRM n	<p><i>The Alarm Setpoint is available for viewing and editing for any alarm type except ‘equipment alarms’.</i></p> <p>The Alarm Setpoint is the value (in engineering units of assigned variable) at which the alarm condition occurs and therefore the alarm is on.</p> <p>Each alarm is completely independent, e.g. a High alarm does NOT need to have a higher setpoint than the a Low alarm.</p>

SET ↓	▶ → UNITS PARAMS INPUTS OUTPUTS ALARMS COMMS TM/LOG SETUP TEST END
HYST ALRMn	<p><i>The Alarm Hysteresis is available for viewing and editing for any alarm type except 'equipment alarms'.</i></p> <p>Alarm hysteresis loops occur when the alarm toggles continuously on and off when the process variable is close to the setpoint.</p> <p>For a high alarm, the alarm activates when the value of the variable rises above the alarm setpoint and deactivates when the value falls below the alarm setpoint minus the amount of the hysteresis setting (if any).</p> <p>For a low alarm, the alarm activates when the value of the variable falls below the alarm setpoint and deactivates when the value rises above the alarm setpoint plus the amount of the hysteresis setting (if any).</p> <p>For a band alarm, the alarm activates whenever the value of the variable is outside the setpoint plus or minus the amount of the hysteresis.</p> <p>For example, with a high alarm setpoint of 200, and a hysteresis setting of zero, a value oscillating between 197 and 202 will cause the alarm to toggle on at 200 and toggle off below 200. However, if the hysteresis is set to 5, the value of the variable must fall below 195 to cancel the alarm. The alarm will reactivate only when the value again rises above 200.</p>

Communications

The instrument has three communication ports:

- **RS-232 Port** - Three terminals on the rear of the instrument. There is also an optional 9-pin female connector on the rear panel of the instrument.
- **Infra-red Port** - (Display panel option only) Located on the front panel, below the status indicators.
- **RS-485 Port** - Terminals on the rear panel.

<input type="button" value="SET"/> ↓	<input type="button" value="▶"/> → UNITS PARAMS INPUTS OUTPUTS ALARMS COMMS TM/LOG SETUP TEST END
PROTOC RS232 RS485 INFRA	<p>The Communications Protocols can be assigned to the communication ports as follows (a protocol cannot be assigned to more than one port at a time):</p> <ul style="list-style-type: none"> • RTU - Modbus RTU available for all ports • PRN - Printer Protocol available for RS232 and RS485 • NONE - If a port is not being used, set the protocol to NONE. <p>Printer Protocol (PRN) is only available if the option with Real Time Clock is installed.</p> <p>For the selected port, press <input type="button" value="▲"/> or <input type="button" value="▼"/> to select the desired protocol.</p>
BAUD RS232 RS485 INFRA	<p>The Baud setting is the speed of the communication port in data bits per second.</p> <p>The baud rate of the instrument must match the baud rate of the communication device that the instrument is connected to.</p> <p>Use <input type="button" value="▲"/> or <input type="button" value="▼"/> to select 2400, 4800, 9600 or 19200 baud.</p>
PARITY RS232 RS485 INFRA	<p>The Parity bit helps to detect data corruption that might occur during transmission.</p> <p>The parity bit setting of the instrument must match the parity bit setting of the communication device that the instrument is connected to.</p> <p>Press <input type="button" value="▲"/> or <input type="button" value="▼"/> to select EVEN, ODD, or NONE.</p>
S-BITS RS232 RS485 INFRA	<p>The Stop bit indicates the end of a transmission. Stop bits can be 1 or 2 bit periods in length. The stop bit setting of the instrument must match the stop bit setting of the communication device that the instrument is connected to.</p> <p>Press <input type="button" value="▲"/> or <input type="button" value="▼"/> to select 1 or 2 stop bits.</p>
RTU DATA	<p>The Modbus RTU data format for the 2-register (4-byte) values can be set as either floating point or long integer values.</p> <p>Use <input type="button" value="▲"/> or <input type="button" value="▼"/> to select FLOAT or INTEGER.</p>

<input type="button" value="SET"/> ↓		<input type="button" value="▶"/> → UNITS PARAMS INPUTS OUTPUTS ALARMS COMMS TM/LOG SETUP TEST END
RTU	ADDR	<p>The Modbus RTU protocol address must be in the range of 1 to 247. When multiple instruments (slaves) are connected to one communication device (master), each assigned address must be unique.</p> <p>Note: The master device uses the RTU address 0 (zero) for broadcasting to all connected slave units.</p>
FLASH	PORT	<p>The Flash Driver Port assignment defines the communication port for downloading software into the instrument.</p> <p>The default setting of this assignment is the RS-232 port.</p> <p>Press <input type="button" value="▲"/> or <input type="button" value="▼"/> to select RS-232, RS-485, or INFRA.</p>

Time Settings and Data Logging

Instrument Clock

Note: The real-time clock is part of the advanced option package.

The instrument has a real-time clock for recording logged events. The clock displays the time and the date. The date format can be set to European format (day/month/year) or American format (month/day/year). The time clock uses the 24-hour format.

The clock will continue to operate for up to 5 years (typically) on the internal battery if there is no power connected to the instrument. Therefore, after an interruption to the power supply, the instrument recommences normal operation although there will be no data recorded during the period without a power supply.

Note: If there is an interruption to the power supply and the battery has failed, the instrument displays an error message when the power supply is restored. In this case, you should set the current time and date so that the instrument continues to log data at the correct times.

Data Logging

The instrument will log the main-menu variables if real-time clock option is installed. The logs are at fixed intervals which can be programmed to a combination of hours, days, weeks, months and years. The instrument can store a total of 100 log entries. For example, you can specify 40 hourly logs, 30 daily logs, 15 weekly logs, 10 monthly logs and 5 yearly logs.

If the number of log entries exceeds the programmed number for a particular time interval, the oldest log entry is over written by the newest one for that time interval.

The log parameters (below) for each timebase also determine the number of records to be included in a report print out if the printing option is used.

SET ↓	▶ → UNITS PARAMS INPUTS OUTPUTS ALARMS COMMS TM/LOG SETUP TEST END
DATE FORM	<p>Clock Date Format</p> <p>The European date format is: dd/mm/yyyy or (Day-Month).</p> <p>The American date format is: mm/dd/yyyy or (Month-Day).</p> <p>Press ▲ or ▼ to select DAY-M or M-DAY</p>
CLOCK YEAR	The Clock Year defines the current year for the real-time clock.
CLOCK M-DAY	The Clock M-DAY setting defines the current month and date for the real-time clock. This parameter is programmed in Month-Day format for both European and American date formats.
CLOCK H-MIN	The Clock H-MIN setting is the current time in hours and minutes for the real-time clock.
HOUR LOGS	<p>Set the number of Hourly Logs to be recorded and to appear on the printed log report.</p> <p>The hourly log entry occurs at 00 minutes each hour.</p>
DAY LOGS	<p>Set the number of Daily Logs to be recorded and to appear on the printed log report.</p> <p>The daily log entry occurs at 00 hours and 00 minutes each day.</p>
WEEK LOGS	<p>Set the number of Weekly Logs to be recorded and to appear on the printed log report.</p> <p>The weekly log entry occurs at 00 hours and 00 minutes each Monday.</p>
MONTH LOGS	<p>Set the number of Monthly Logs to be recorded and to appear on the printed log report.</p> <p>The monthly log entry occurs at 00 hours and 00 minutes on the first day of the month.</p>

SET ↓		▶ → UNITS PARAMS INPUTS OUTPUTS ALARMS COMMS TM/LOG SETUP TEST END
YEAR	LOGS	<p>Set the number of Yearly Logs to be recorded and to appear on the printed log report.</p> <p>The yearly log entry occurs at 00 hours and 00 minutes on the first day of the year.</p>
RESET	LOGS	<p>Reset the logged data. You may need to reset (clear) the logged data if you change the time/log settings.</p> <p>Press ▲ or ▼ to select YES, then press the SET key. The instrument makes three beeps to confirm the reset command.</p>
REPORT	TYPE	<p>The Printer Protocol Report Type determines the nature of the printout from the REPORT PRINT - HOLD.SET prompt in the main menu. The following report types available in this instrument are:</p> <ul style="list-style-type: none"> • REP-01 Hourly Logs Report • REP-02 Daily Logs Report • REP-03 Weekly Logs Report • REP-04 Monthly Logs Report • REP-05 Yearly Logs Report • REP-06 Previous Day's 24 Hour Report (0Hr – 23Hr, minimum 48 hourly logs required) <p>Press ▲ or ▼ to select Report Type.</p>
PRN	TYPE	<p>The Printer Protocol Printer Type allows the nature of the printer being used to be specified. The following printer types available in this instrument are:</p> <ul style="list-style-type: none"> • PRN-01 Generic computer printer • PRN-02 Generic roll printer (prints first line first) • PRN-03 Slip printer TM295 <p>Press ▲ or ▼ to select Printer Type.</p>
PRINT	ACCUM	<p>Select whether the accumulated totals are printed in addition to the non-accumulated totals for printer protocol.</p>

General Setup Parameters









SET ↓	▶ → UNITS PARAMS INPUTS OUTPUTS ALARMS COMMS TM/LOG SETUP TEST END
DEFAULT TOTAL	<p>The instrument displays the default Total when the user presses the TOTAL key.</p> <p>If the display timeout is enabled, the instrument displays the default Total when there is no user action for the period of the display timeout period.</p> <p>Press ▲ or ▼ to select the default total display.</p>
SUPPLY VOLT	<p>The instrument provides a power-limited supply for external transducers.</p> <p>Press ▲ or ▼ to set the transducer supply voltage between 8 and 24 volts DC as required.</p>
T-OUT MODE	<p>If the Display Timeout mode is enabled, and there is no user activity for the defined timeout period, the display panel returns to the default display.</p> <p>This function is useful for the following reasons:</p> <ul style="list-style-type: none"> • to return the display to a preferred variable after the user has finished reading other information, • to cancel the calibration mode and return to the default display if the user does not exit from the calibration mode for any reason. <p>Press ▲ or ▼ to select the display timeout function as follows:</p> <ul style="list-style-type: none"> • DISABLE - Timeout is completely disabled. • EN DISP - Timeout is enabled during Normal mode and Calibration View mode. • EN EDIT - Timeout is enabled during Calibration Set mode. • EN ALL - Timeout is enabled for all modes.
T-OUT SEC	<p>The Display Timeout period defines the delay for the Display Timeout mode if it is enabled.</p> <p>The display timeout period can be from 10 to 99 seconds.</p>

SET ↓		▶ → UNITS PARAMS INPUTS OUTPUTS ALARMS COMMS TM/LOG SETUP TEST END
RESET	MODE	<p>The Totals Reset mode can be configured to reset the non-accumulated totals to zero.</p> <p>Press ▲ or ▼ to select the reset mode as follows:</p> <ul style="list-style-type: none"> • NONE - The user cannot reset the non-accumulated totals. • INSTANT - When the user presses the RESET key, the instrument resets all non-accumulated totals. • DELAYED - When the user presses the RESET key and holds it for two seconds, the instrument resets all non-accumulated totals. • CAPTURE - When the user presses the RESET key, the instrument resets all non-accumulated totals, with the last value being displayed for 15 seconds. Totalising is maintained in the background while the captured value is held on the display.
RESET	ACCUM	<p>The Reset Accumulated Totals function clears all of the accumulated totals and the non-accumulated totals.</p> <p>Press ▲ or ▼ to select YES, then press the SET key. The instrument makes three beeps to confirm the reset command.</p>
DISPL	TAGS	<p>The Display Tags option determines whether the instrument displays the default display tags or the user-defined tags. The display tag setting also defines whether the instrument displays the default error and warning messages, or the user-defined messages.</p> <p>Note: The user-defined tags can be entered into the instrument only by the manufacturer or the distributor.</p> <p>Press ▲ or ▼ to select the Display Tags option as follows:</p> <ul style="list-style-type: none"> • DEFAULT - the instrument displays the default (English) tags • USER - the instrument displays the user-defined tags.
BACK-L	T-OUT	<p>If the backlight timeout is enabled, and there is no user activity (any keys pressed) for a period of 10 seconds, the display backlight switches off to save power. The backlight switches on when a key is pressed. Select the backlight timeout mode as required.</p> <p>Press ▲ or ▼ to select ENABLE or DISABLE.</p>
RATES	DP	<p>This parameter sets the maximum number of decimal places for displaying or printing main menu rates.</p>
TOTALS	DP	<p>This parameter sets the maximum number of decimal places for displaying or printing main menu totals.</p>

Test Menu

The Test menu enables you to view the inputs and outputs to and from the instrument.

In Calibration Set mode, (by entering the system password) you can control the outputs and the alarms as described in the table below.

 ↓	 → UNITS PARAMS INPUTS OUTPUTS ALARMS COMMS TM/LOG SETUP TEST END
FINP Hz	The frequency of the input to FINP is displayed in Hertz.
AINP mA	The current of the signal input to AINP is displayed in milliamps.
LINP _n STATE	You can view the state of the logic input. If the input is an open contact or inactive it will display HI . If the input is a closed contact or active it will display LO .
OUT _n STATE	You can control the state of the outputs. Press the  or  keys to set the output state as follows: <ul style="list-style-type: none"> • PROCESS - the output depends on the current values of the inputs and the calculations that the instrument performs. • ON - the output is a pulse train with a pulse width as set for the particular output in the Outputs menu. • OFF - no output.
A-OUT STATE	You can control the state of the outputs. Press the  or  keys to set the output state as follows: <ul style="list-style-type: none"> • PROCESS - the output depends on the current values of the inputs and the calculations that the instrument performs. • HI - the output is set to 20mA. • LO - the output is set to 4mA.
ALARM _n STATE or REL - _n	You can control the state of the relays (alarms). Press the  or  keys to set the selected relay as follows: <ul style="list-style-type: none"> • PROCESS - the relay operates according to the current values of the inputs and the relay settings as programmed. • OPEN - the relay output contacts are set to “open”. • CLOSED - the relay output contacts are set to “closed”.
SUPPLY V	You can display the actual DC output supply voltage, which may help with troubleshooting. If the actual supply voltage is lower than the preset value (refer to General Setup Parameters on page 39) it may indicate that the output is overloaded.

System Messages

The instrument displays messages for defined events and fault conditions.

The manufacturer or distributor can enter user-defined text for the messages. This user-defined text is displayed, instead of the default (English) messages, when the Display Tags option in the Setup menu is set to USER.

Error Messages

The system displays error messages as described in the following table:

Error Messages	Description
CPU Card Failure	There are failed components on the CPU card and technical support is required.
Power Supply is Low	The input and/or output power supply voltage is too low, ensure that: (a) input power supply voltage is within the specified range (b) output power supply is not overloaded.
New/Failed Battery - Set Time	The real-time clock has lost the correct time because the battery has failed, or there is a new battery. Set the current time and date (in the TM/LOG menu) to clear the error message and to continue data logging at the correct times. Note: The instrument can continue operating with a failed battery, but the correct time will be lost if there are interruptions to the power supply.
Flowrate Input Failure	The flowrate sensor (analog input) has failed. It is not possible to override this error condition. The instrument cannot operate without a flowrate input.

Warning Messages

The system displays warning messages as described in the following table:

Warning Messages	Description
Value Has Been Set to Default	You have entered an invalid value for a parameter. Therefore, the instrument has set the default value.
Over Total Limit - Maximum Set	You have exceeded the maximum number of logging entries for the combined time bases. The instrument has set the current log setting to the remaining maximum number.
Already Assigned to Other Port	You have tried to assign a particular protocol type to more than one serial communication port. The instrument has set the protocol to NONE.

Chapter 6

Communications

Overview

This chapter describes the communications between the instrument and another communicating device such as a computer or a printer. You should have relevant information about the devices to which the instrument will be connected. Some connection examples are included in this manual, however, the operation and connection of other devices is outside the scope of this manual.

Hardware Interconnection

The instrument has three communication ports:

- RS-232 port on the rear panel (plus extra DB9 female connector)
- RS-485 port on the rear panel
- Infra-red port on the front panel (display panel option only)

The appropriate interface and protocols are selected during calibration.

RS-232 Port

The RS-232 port provides communication between the instrument and one other device such as a host computer or a printer.

Note: A printer must have a serial port to be able to be directly connected to the flow computer. It is not possible to communicate directly with a printer via a parallel port.

Computers use either a DB9 or a DB25 connector, and the connections to each type are shown in Figure 14.

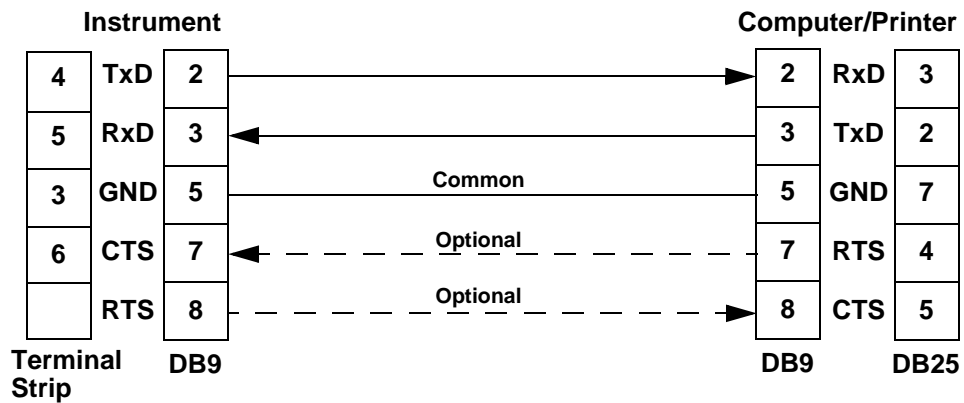

Figure 14 RS-232 Cable Connections to a Computer

Note: The instrument requires a cable with straight-through connections. Do not use a null modem cable for RS-232 connection to a computer.

RS-485 Port

The RS-485 port enables communication with multiple devices. Each device has a unique address so that the “master” device can communicate with specific “slave” devices.

On RS-485 links, an external terminating resistor must be connected at the furthest end of the cable. When multiple instruments are connected, they should be “daisy chained” in a multidrop configuration as shown in Figure 15. Up to 32 units can be connected to the interface at a maximum distance of 1200 metres.

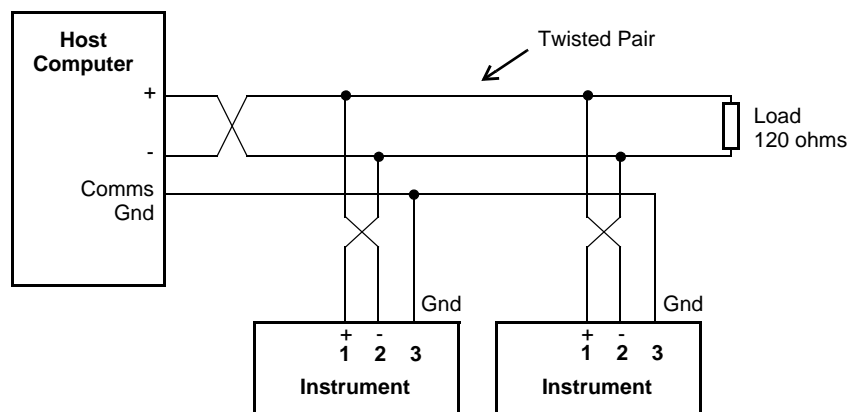

Figure 15 RS-485 Connections

Infra-red Port

The infra-red port is located on the front panel of the instrument. The infra-red port uses the Infra-red Developers Association (IrDA) physical layer format of signal encoding and decoding.

The nature of the infra-red port requires the communicating device to be located close to the front of the instrument. Therefore, its main use would probably be for reloading the instrument application software, or occasional collection of data, rather than continuous communications.

Protocols

The communications protocols can be assigned to the communication ports on the instrument as follows:

- **RTU** - Modbus RTU available for all ports
- **PRN** - Printer Protocol available for RS232 and RS485
- **NONE** - If a port is not being used, set the protocol to NONE.

Note: The Printer Protocol is only available if the option with Real Time Clock is installed. Also a protocol cannot be assigned to more than one port at a time as described in [Communications](#) on page 34.

- **Modbus RTU** - Modbus RTU is an industry-standard protocol which allows the instrument to be easily connected to computers running supervisory software systems.
- **Printer** - In the Printer protocol there is a selection of printer types. Please refer to the [Printer Protocol](#) on page 54 for full details.

Modbus RTU Protocol

Modbus RTU (remote terminal unit) is an industry standard protocol that allows the instrument to be easily interfaced to other communication devices.

The instrument implements the Modbus protocol as detailed in the *Modicon Modbus Protocol Reference Guide* PI-MBUS-300 Rev J (June 1996).

Message Format

In RTU mode, messages start with a silent interval of at least 3.5 character times. The first field transmitted is the device address. Following the last transmitted character, a similar interval of at least 3.5 character times marks the end of the message. A new message can begin after this interval. The entire message frame must be transmitted as a continuous stream. A typical message frame is shown below:

Address	Function	Data	CRC Check
1 byte	1 byte	n bytes	2 bytes

Except for broadcast messages, when a master device sends a query to a slave device, it expects a normal response. One of four possible events can occur from the master's query:

- If the slave device receives the query without a communication error, and can handle the query normally, it returns a normal response.
- If the slave does not receive the query due to a communication error, no response is returned. The master program has to process a timeout condition for the query.
- If the slave receives the query, but detects a communications error (parity or CRC), no response is returned. The master program has to process a timeout condition for the query.
- If the slave receives the query without a communication error, but cannot handle it (for example, if the request is to read a nonexistent register), the slave will return an exception response informing the master of the nature of the error.

Instrument Address

The address of the instrument is programmable in the range from 1 to 247. Some addresses are reserved according to PI-MBUS-300 and have a special meaning:

- 0 = Broadcast, no response required from slave devices
- 248 to 255 Reserved

Function Codes

The instrument accepts the following function codes:

Code	Name	Description
03	Read data register(s)	Obtain the content of one or more 2-byte data registers.
06	Preset data register	Preset one 2-byte data register.
07	Read status register	Obtain the content of 1-byte status register.
16	Preset data register(s)	Preset one or more 2-byte data registers.

Exception Response

The instrument forms an exception response by adding 80H to the function code and using an exception code as the 1-byte data field in the returned frame. Implemented exception codes are as follows:

Code	Name	Description
01	Illegal function	The function code is not a legal action for the slave.
02	Illegal data address	The data address is not a legal address for the slave.
03	Illegal data value	The data value is not a legal value for the slave.
05	Acknowledge	The slave has accepted the request and is processing it, but a long duration of time will be required to do so.
06	Slave device busy	The slave is engaged in processing a long duration program command. The master should re-transmit the message later when the slave is free.

List of Data Registers

The following list describes the addresses and meaning of the data registers in the instrument. The data values are expressed in the engineering units that were selected for the variables when the instrument settings were configured. The “Data Type” for the 2-register (4-byte) data values can be set in programming mode as Floating Point or Long Integer as described in [Communications](#) on page 34.

The registers are grouped in blocks that relate to a particular function of the instrument.

Note: Conventional numbering of registers often starts from 1, therefore be aware that “register 1” in this case has “address 0” and so on.

Current and Logged Process Data

This block of registers is available for the retrieval of current or logged process data with its matching time and date information.

Use the log timebase and log number to retrieve the logged information from the appropriate register. If a particular log number does not exist, or the instrument does not have the optional real-time clock, the time and date stamp and associated variables are set to zero.

Register	Name	Comments	Read Only or Read/Write	Type
1	Volume	<p style="text-align: center;">Process Variables</p> <p>By default totals are the Accumulated values. If current Non-accumulated (resettable) totals are required, set register 37 to 06. All logged totals are the Accumulated values.</p>	R	DT*
3	Volume Flowrate		R	DT
5	User Value		R	DT
7	Reserved		R	DT
9	Reserved		R	DT
11	Reserved		R	DT
13	Reserved		R	DT
15	Reserved		R	DT
17	Reserved		R	DT
19	Reserved		R	DT
21	Reserved		R	DT
23	Reserved		R	DT
25	Reserved		R	DT
27	Reserved		R	DT
29	Reserved	R	DT	
31	Year	<p style="text-align: center;">Current Date/Time or Logged Date/Time Stamp (see register 38 Log Number). Only current Date/Time can be edited</p>	R/W	I†
32	Month		R/W	I
33	Date		R/W	I
34	Hour		R/W	I
35	Minute		R/W	I
36	Second		R	I
37	Log Type	00 - hourly or log records 01 - daily 02 - weekly 03 - monthly 04 - yearly 05 - last edit of calibration 06 - current totals are non-accumulated values, register 38 is ignored.	R/W	I
38	Log Number	If set to 0, current variables and Date/Time are retrieved	R/W	I
39	Clear Data	01 - clear logs 02 - clear accumulated totals 03 - clear non-accumulated totals	W	I
40	Reserved			

* DT = Data Type of 2-register (4 byte) values can be set as Floating Point or Long Integer values

† I = Integer (2 bytes) (Holding Registers)

Note: The Floating Point variable is represented in IEEE-754 Floating Point 4-byte format and requires two 2-byte data registers:

IEEE-754	Modicon Registers
1st byte	low byte (register X)
2nd byte	high byte (register X)
3rd byte	low byte (register X+1)
4th byte	high byte (register X+1)

This means that two data registers must be read or written to obtain, or preset, one data value.

Instrument Exception Status

This register is available to verify the status of the instrument.

Register	Name	Comments	Read Only or Read/Write	Type
41	Exception Status	00 = no error 01 = analog input 1 failure 02 = analog input 2 failure 03 = analog input 3 failure 04 = analog input 4 failure 05 = invalid calibration parameter 06 = invalid reference parameter 07 = invalid property 08 to 09 reserved 10 = process parameters out of range 11 = input is over limit 12 = flow error detected 20 = system failure 21 = power supply is low 22 = new or failed clock battery 23 to 29 reserved 30 = alarm 1 active 31 = alarm 2 active 32 = alarm 3 active 33 = alarm 4 active	R	I*

* I = Integer (2 bytes) (Holding Registers)

Instrument Control and I/O

This block of registers is available in some applications to give access to monitor and/or control some of the instrument.

Register	Name	Comments	Read Only or Read/Write	Type
42	Reserved			
43	Reserved			
44	Reserved			
45	Relay State	0 to 15 Binary representation of relay state. 0 = open; 1 = closed. B0 = relay 1 (LSB) B1 = relay 2	R	I*
46	Relay Control	0 to 15 Binary representation of relay control. 0 = open; 1 = close. B0 = relay 1 (LSB) B1 = relay 2	R/W	I
47	Relay Control Source	0 to 15 Binary representation of relay control source. 0 = Local (controlled by instrument operation) 1 = RTU (controlled by Modbus register 46). B0 = relay 1 (LSB) B1 = relay 2	R/W	I
48	Reserved			
51 to 99	Instrument Parameters	See next table for details.		DT
101	Analog Input	The input is configured for 4-20mA. The value will be read in Amperes.	R	DT†

* I = Integer (2 bytes) (Holding Registers)

† DT = Data Type of 2-register (4 byte) values can be set as Floating Point or Long Integer values

Instrument Configuration Parameters

This block of registers is available in applications to give access to some important instrument parameters (i.e. fluid properties etc).

The usage of these parameters can be dependent on other instrument settings. For full description, please refer to the “Modbus Accessible Parameters” in .

Register	Name	Comments	Read Only or Read/Write	Type
51	User Value		R/W	DT
53 to 99	Reserved		R/W	DT

Printer Protocol

A printer protocol is available in the 500 Series. It provides the ability to print out live data, individual logged data and to do some report-style printing of logged data. The method of printing these and the format of the printouts is described below.

Note: Printer output is only available if the Real Time Clock option is fitted.

The selection of Printer Protocol can be made for the Communications Protocol options for the RS232 or RS485 port. A list of log report types and printer types available at the end of the TM-LOG calibration menu.

Report Types

The list of report types is as follows:

- REP-01 Hourly Logs Report
- REP-02 Daily Logs Report
- REP-03 Weekly Logs Report
- REP-04 Monthly Logs Report
- REP-05 Yearly Logs Report
- REP-06 Previous Day Hourly Logs (0Hr – 23Hr, minimum 48 hourly logs required)

The number of logs printed in each report are determined by the values programmed for each timebase in the TM-LOG menu.

Printer Types

The list of available printers is as follows:

- PRN-01 Generic computer printer
- PRN-02 Generic roll printer (printing first line first)
- PRN-03 Slip Printer TM295

Customizing a Printout

A customized printout can be provided which can have up to 4 header lines and 3 footer lines. It is also possible to include or exclude each main menu items on the printout. If any customizing of the printout is required discuss this with the distributor.

Types of Printouts

Live Data

The RESET key, when in main menu, is shared as the PRINT key if the printer protocol has been selected. A printout will be initiated whenever this key is pressed. If printing is not required, do not select printer protocol.

The format of this printout will be:

Custom Header Line 1
Custom Header Line 2
Custom Header Line 3
Custom Header Line 4

Current Docket No.

Instrument Serial No. & Tag

Current Date & Time & Status

<i>Total Variable</i>	<i>unit</i>	<i>value</i>	<i><Resettable total first></i>
<i>Total Variable</i>	<i>unit</i>	<i>value (acc)</i>	<i><Accumulated total second></i>
<i>Variable</i>	<i>unit</i>	<i>value</i>	
<i>Variable</i>	<i>unit</i>	<i>value</i>	

etc.

Custom Footer Line 1

Custom Footer Line 2

Custom Footer Line 3

----- *<separation line>*

(Note that blank header and footer lines are not printed).

Docket Number

The docket number that appears on the live data printout indicates the print number. This number is cleared when the Accumulated totals are reset. If the Reset Mode is set for Delayed, where a print can be generated without resetting the non-accumulated totals, an additional number in brackets will be shown that indicates the number of prints since the last reset. i.e.

DOCKET No. *000256* *(000036)*

Instrument Serial Number and Unit Tag

The instrument serial number and unit tag is the same as the information shown in the Model Info menu. For more details refer to [Model Information](#) on page 20.

Individual Log Data

When in the Log Menu and while holding the DISPLAY key to view the data of the log of interest the RESET key can be pressed to initiate a printout of that log entry. The printout will have the time and date stamp corresponding to when the log was taken. After the print has been initiated there will be the opportunity to scroll to view another log entry and print again.

Since in each log entry all totals are stored as the Accumulated value, the printout will not have any resettable totals. The format of the printout with this exception is the same as the LIVE DATA printout:

Custom Header Lines

Instrument Serial No. & Tag

Log Date & Time & Status

Variable *unit* *value* <example: total as Accum only>

Variable *unit* *value*

etc.

Custom Footer Lines

----- <separation line>

Log Report Printing

As there is the likelihood that the reports can be of a considerable length it is strongly recommended that only the 80 Column printer with Z fold (tractor feed) paper be used. This is just as much for the memory storage of printer as it is for the reliable paper supply.

There is a HOLD.SET REPORT PRINT prompt under the main menu with the ability to print the pre-selected type of report. Pressing and holding the SET key for two seconds will initiate the printout. Any of the Log Reports will have the following format:

Custom Header Lines

Title of Report

<internally set, indicates report type>

Current Date & Time

Instrument Serial No. & Tag

----- <separation line>

Log No. Date & Time & Status

Variable *unit* *value* <example: total as Accum only>

Variable *unit* *value*

etc.

----- <separation line>
Log No. Date & Time & Status
Variable unit value <example: total as Accum only>
Variable unit value
etc.

----- <separation line>
Log No. Date & Time & Status
Variable unit value <example: total as Accum only>
Variable unit value

ETC

Custom Footer Lines

----- <separation line>

Reports such as “All Hourly Logs” will print in the historical order, and for those logs that have no data (e.g. unit was powered off at the time) the print will show “Data not available”. i.e.

Log No. Date & Time & Status
Variable unit value <example: total as Accum only>
Variable unit value
etc.

----- <separation line>

Log No. Data Not Available

----- <separation line>

Log No. Date & Time & Status
Variable unit value <example: total as Accum only>
Variable unit value
etc.

If the unit is programmed for 0 logs for a particular time base then the report for that time base will only consist of the header and ID information and a “Data Not Available” message. Likewise for the 0Hr to 23Hr report to print the complete report there must be a minimum of 48 hourly logs programmed otherwise “Data Not Available” will be printed for the missing logs.

Custom Header Lines

Title of Report

Current Date & Time
Instrument Serial No. & Tag

Data Not Available

Custom Footer Lines

----- <separation line>

Printer Data Control

Some printers have limited data buffers and are therefore unable to collect all the print data being transmitted. The 500 Series has the capability of software handshaking. The Xon/Xoff characters can be used by any of the printer types to control the flow of data to ensure that data is not lost.

Some printers will also transmit an Xoff character in response to other events such as printer being off-line, print head not engaged or power being removed. The specific behaviour of the printer being used should be noted.

Error Messages

There are two printer error messages that can be displayed.

PAPER OUT

This message is related to the Printer Type PRN-03 TM295 Slip printer. It is standard procedure with this printer to check for paper status before printing. If a print is attempted but there is no paper the PAPER OUT message will be scrolled. The instrument will continue to poll the printer for paper and if paper is detected before a communications timeout expires the print will commence.

COMMS TIMEOUT

This message is relevant for all printer types and will be activated for the following conditions.

1. If the flow of data is stopped due to software or hardware handshaking and is not allowed to resume before the communications timeout.
2. If Printer Type is PRN-03 Slip printer and a paper status is requested but no response is received within the timeout period.
3. Paper Out has been detected for Printer Type PRN-03 but no paper is inserted within the timeout period.

When a communications timeout error has been activated the message COMMS TIMEOUT will be scrolled once, the request to print will be cleared and the instrument will return to its normal mode.

Appendix A

Model Numbers

Product Codes

Model	Supplementary Code		Description
505	- FC02		
Enclosure	1		Panel mount enclosure
	2		Field mount enclosure (not yet available)
	3/5		Explosion proof Ex410 with metric glands (5 specifies heater version)
	4/6		Explosion proof Ex410 with NPT glands (6 specifies heater version)
Output Options	0		Basic - RS232 and RS485 serial ports, 2 relays, 2 pulse outputs, rear key input
	1		Advanced - also includes 4-20mA o/p and Real-time clock for printer output and logging (100 logs)
Extra Options	2		9-way DB connector for RS232 serial port
Power Supply	E		For 220/240VAC
	A		For 110/120VAC
	D		For DC power only 12-28VDC
Display Panel Options	S		Standard (no backlight, LCD backup or Infra-Red comms port)
	F		Fully optioned (with backlight, LCD backup and Infra-Red comms port)
PCB Protection	C		Conformal coating - required for maximum environmental operating range. Recommended to avoid damage from moisture and corrosion.
	N		None - suitable for IEC standard 654-1 Climatic Conditions up to Class B2 (Heated and/or cooled enclosed locations)
Application Pack Number	FC02		Defines the application software to be loaded into the instrument
For example: Model No. 505.112EFC Displayed on the 500 Series as: (only h/w that affects the operation is represented)			- 1 - - F - 505 MODEL

Note: Example full product part number is 505.112EFC-FC02 (This is the number used for placing orders).

Custom Version Codes

	Code		Description
Origin Code Identifies Distributor	00		Factory Default Application
	01		Contrec Pty. Ltd. Melbourne Australia
	02		Contrec Pty. Ltd. Sydney Australia
	03		Contrec Europe Ltd. West Yorkshire UK
	04		Contrec - USA, LLC. Pelham AL 35124 USA
	05		Flowquip Ltd. Halifax UK
	06		
	etc.		
User Language	0		English (Default)
	1		German
	2		Dutch
	3		French
	4		Spanish
	5		
	etc.		
Distributor's Code	000		Distributor's own choice. Possibly a code that identifies the customer and the application.
	...		
	999		
For example: 02 3 157 Displayed on the 500 Series as:			023 157 CUSTOM VERS

Application Information Code

The Application Information code is an aid for users and service personnel to determine the type of inputs that are used in a particular application. The Application Information code is displayed on the instrument as shown below.

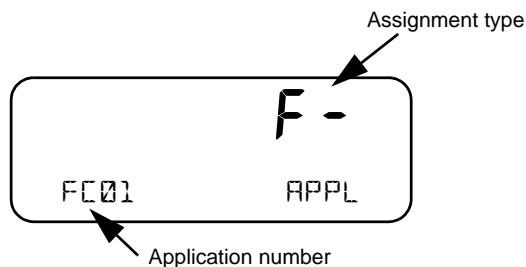

The Application number identifies the application as in the following examples:

- BC01 - single channel batch controller for frequency flow input.
- FC01 - single channel flow computer for frequency flow input

The Input Assignment type indicates the physical input that is assigned to each input on the instrument. The code is made up from two characters as follows:

FINP	AINP
X	X

The codes are as follows:

- - - not used in this application
- *A* - indicates an analog flow input such as for volume or mass
- *F* - indicates a frequency flow input such as for volume or mass
- *L* - indicates a level input
- *d* - indicates a density input
- *t* - indicates a temperature input.

For example, *FL* is an instrument with FINP (frequency input) assigned to a flow input, AINP (analog input) assigned to a level input.

Appendix B

Units of Measurement

Available Units of Measurement

The following is a list of the available units of measurement used across the range of 500 Series applications.

Units Type	Available units of measurement
Volume	m ³ , Km ³ , Ltr, Gal, KGal, MGal, ft ³ , kft ³ , Mft ³ , bbl
Volume Flowrate	m ³ /s, m ³ /min, m ³ /h, m ³ /D, L/s, L/min, L/h, Gal/s, Gal/min, Gal/h, KGal/D, MGal/D, ft ³ /s, ft ³ /min, ft ³ /h, Mft ³ /D, bbl/s, bbl/min, bbl/h, bbl/D
Volume K-Factor	P/m ³ , P/Ltr, P/Gal, P/ft ³ , P/bbl
Mass	kg, g, Ton, lb, Klb
Mass Flowrate	kg/s, kg/min, kg/h, g/s, g/min, g/h, Ton/min, Ton/h, Ton/D, lb/s, lb/min, lb/h, Klb/min, Klb/h, Klb/D
Mass K-Factor	P/kg, P/g, P/Ton, P/lb, P/Klb
Energy	kJ, MJ, GJ, kWh, MWh, kBTU, Ton.h, therm, cal, kcal, Mcal
Power	kJ/h, MJ/h, GJ/h, kW, MW, kBT/M, kBT/h, Ton, therm/min, therm/h, kcal/h, Mcal/h
Energy K-Factor	P/kJ, P/kWh, P/kBTU, P/Ton.h, P/therm, P/kcal
Temperature	Deg K, Deg C, Deg F, Deg R
Pressure	Pa, kg/m ² , kg/cm ² , kPa, MPa, mbar, bar, psi, Atm, inH ₂ O, mmH ₂ O
Density	kg/m ³ , kg/Ltr, lb/ft ³ , SG60F
Specific Volume	m ³ /kg, L/kg, ft ³ /lb
Specific Enthalpy	kJ/kg, BT/lb, cal/g, cal/kg, kcal/kg, Mcal/kg
Reynolds Number	E+0, E+3, E+6 (scaling for unitless variable)
Length (Level)	m, mm, cm, INCH, FOOT
Velocity	m/s, m/M, m/h, ft/s, ft/M, ft/h
Length K-Factor	P/m, P/cm, P/INCH, P/FOOT
Area	m ² , ft ²
Ratio	%

Index

Numerics

- 4-20mA
 - input 9
 - output 10

A

- ACCUM key 16
- alarm
 - connection 11
 - equipment failure 32
 - hysteresis 34
 - relays 32
 - setpoint 33
- alarms menu 32
- analog input
 - connections 9
 - scaling 2
- application code 60
- approvals 4

B

- back panel 8
- battery
 - failed 42
 - life 36
 - new 42
- baud rate 35

C

- calibration
 - menu 24
 - set mode 22
 - view mode 21
- clock
 - battery 36
 - date format 37
 - real-time 36
- codes
 - application information 60
 - customer version 60
 - exception 51
 - product number 59

- communication
 - connections 12
 - protocols 47
- communications 3, 45
 - menu 34
- connections
 - alarm 11
 - communication 45
 - communications 12
 - electrical 8
 - input 9
 - output 10
- customer version codes 60
- customizing a printout 54

D

- daily logging 37
- data log
 - viewing 17, 18
- data logging
 - daily 37
 - hourly 37
 - monthly 37
 - weekly 37
 - yearly 38
- date format 37
- default total 15
- display
 - specifications 5
 - timeout mode 39
 - timeout time 39
- DISPLAY key 16
- display-only parameter 21

E

- earthing 13
- electrical connections 8
- equipment failure alarm 32
- error messages 42
- exception codes 51

F

- features 1

flash driver port assignment 36

format, date 37

front panel

infra-red port 13

keys 16

lamps 15

G

general specifications 5

H

hardware connections 45

hourly logging 37

hysteresis, alarm 34

I

infra-red port 13, 34, 47

input

4-20mA 9

connections 9

analog 9

specifications 5

inputs menu 27

installation 7

instrument

settings 26

interconnections, communication 45

interference suppression 12

K

key

ACCUM 16

DISPLAY 16

RATE 16

RESET 16

SET 17

TOTAL 16

keys, front panel 16

L

lamps, status 15

logged data 17

viewing 18

logging

daily 37

hourly 37

monthly 37

weekly 37

yearly 38

logic input connection 9

M

main menu items 16

menu

alarms 32

calibration 24

comms 34

inputs 27

outputs 31

params 27

setup 39

test 41

tm/log 36

units 26

messages

error 42

system 42

warning 43

Modbus accessible parameters 27

Modbus data format 35

Modbus RTU protocol 48

mode

display timeout 39

normal operation 15

set calibration 22

view calibration 21

model numbers 59

monthly logging 37

mounting 7

N

normal operation 15

number

model 59

serial 20

O

operation, normal 15

output

connections 10

4-20mA 10

pulse 10

pulse factor 32

specifications 5

outputs menu 31

P

panel

- lamps 15
- mounting 7
- rear 8

parameter

- display-only 21
- not visible 21
- password-protected 21
- programmable 21

parameters menu 27

parity bits 35

password-protected parameter 21

peak flowrates 17

port

- assignment, flash driver 36
- flash driver assignment 36
- infra-red 13, 34, 47
- RS-232 12, 34, 45
- RS-485 13, 34, 46

power supply interruption 36

printer

- data control 58
- error messages 58
- protocol 54
- report types 54

printer types 54

printouts

- individual logs 56
- live data 55
- log report 56
- types 55

product number codes 59

programmable parameters 21

protocol

- communication 47
- Modbus RTU 48
- printer 54

pulse factor, output 32

pulse output 10

R

RATE key 16

real-time clock 36

rear panel 8

relay outputs 3

relays, alarm 32

remote key input 30

RESET key 16

RS-232 port 12, 34, 45

RS-485 port 13, 34, 46

RTU protocol 48

S

scaling analog input 2

serial number 20

SET key 17

setpoint, alarm 33

settings

- instrument 26

setup menu 39

shielding 13

snubber 12

specifications 5

standards 4

status lamps 15

stop bits 35

suppression, interference 12

system

- errors 42

- messages 42

- warnings 43

T

terminal designations 8

test menu 41

timeout

- mode 39

- time 39

tm/log menu 36

TOTAL key 16

total, default 15

U

unit tag 20

units

- menu 26

User value 17

V

version, customer 60

view data logs 17, 18

W

warnings 43

weekly logging 37

Y
yearly logging 38